



EGLO
my light | my style



AvBenlevhten

Outdoor Luminaires

Luminaires exterievrs



Dear customers and business partners,
our loyal EGLO friends,

We offer you the perfect lighting for your garden, your terrace and balcony. Our assortment of outdoor luminaires ranges from classic, to traditional, modern and extravagant luminaires.

However, outdoor luminaires are not only useful for aesthetic reasons but also provide the necessary security around your home, especially in the dark autumn and winter months. With our Safety & Comfort luminaires, which are all equipped with motion sensors, you can keep uninvited visitors away.

Our Smart Light Bluetooth System "connect" is also an important part of our innovative outdoor lamp range.

Have fun browsing
our catalogue!

Geschätzte Kunden und Geschäfts-
partner, treue EGLO-Freunde,

Wir bieten Ihnen die perfekte Beleuchtung für Ihren Garten, Ihre Terrasse oder Ihren Balkon. Unser Sortiment an Außenleuchten reicht von klassischen bis hin zu modernen, extravaganten und traditionellen Leuchten.

Außenleuchten sind aber nicht nur aus ästhetischen Gründen sinnvoll, sondern sorgen vor allem in den dunklen Herbst- und traditionellen Wintermonaten für die nötige Sicherheit rund um Ihr zu Hause. Mit unseren Leuchten der Linie Safety & Comfort, die alle über Bewegungssensoren verfügen, halten Sie ungebetene Besucher fern.

Auch weiterhin ist unser Smart Light Bluetooth System „connect“ wichtiger Bestandteil unseres innovativen Außenleuchtensortiments.

Viel Vergnügen beim Durchstöbern
unseres Kataloges!

Chers clients, chers partenaires com-
merciaux, chers amis d'EGLO,

Nous vous proposons l'éclairage parfait pour le jardin, la terrasse ou le balcon. Notre palette d'éclairages extérieurs s'étend des modèles classiques et traditionnels aux éclairages modernes et extravagants.

Cependant, les luminaires extérieurs ne sont pas seulement utiles pour des raisons esthétiques, mais également pour assurer la sécurité nécessaire autour de votre maison, en particulier pendant les mois sombres d'automne et d'hiver. Avec nos luminaires Safety & Comfort, tous équipés de capteurs de mouvement, vous pouvez éloigner les visiteurs indésirables.

Notre système Bluetooth de lumière intelligente « connect » est un élément important de notre gamme innovante de luminaires extérieurs.

Nous vous souhaitons beaucoup de plaisir en feuilletant notre catalogue !



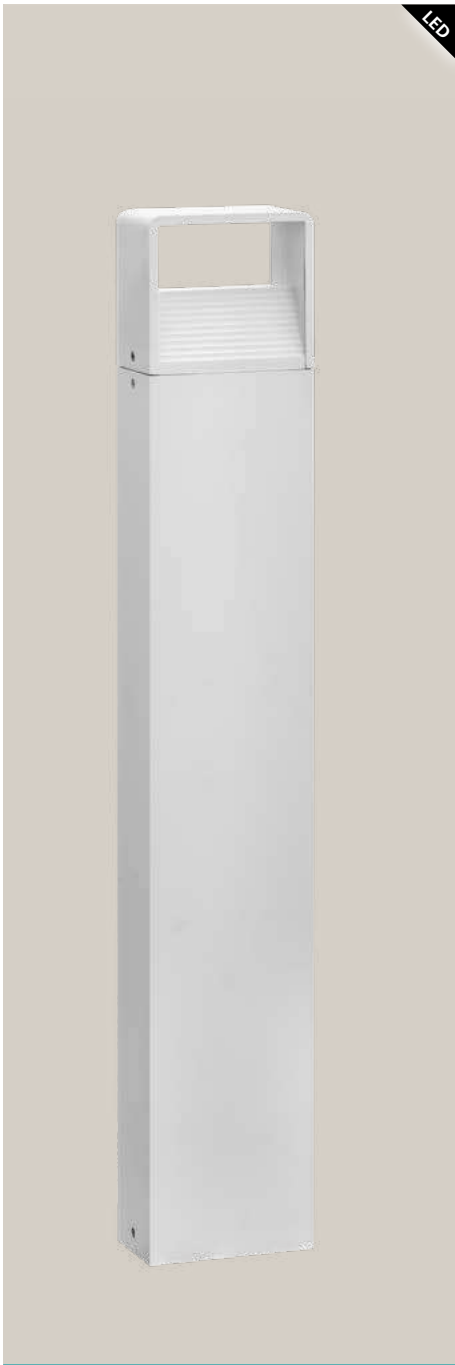

98267 DONINNI 1

pedestal light; aluminium, white / plastic, white
 Sockelleuchte; Alu, weiss / Kunststoff, weiss
 luminaire pour socle; aluminium, blanc / plastique, blanc

L 135, B 75, H 400



98266 DONINNI 1

wall light; aluminium, white / plastic, white
 Wandleuchte; Alu, weiss / Kunststoff, weiss
 applique; aluminium, blanc / plastique, blanc

L 135, B 120, H 75

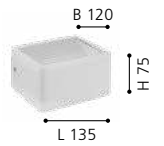

98268 DONINNI 1

floor light; aluminium, white / plastic, white
 Stehleuchte; Alu, weiss / Kunststoff, weiss
 lampadaire; aluminium, blanc / plastique, blanc

L 135, B 75, H 800



98271 DONINNI 1

pedestal light; aluminium, anthracite / plastic, white
 Sockelleuchte; Alu, anthrazit / Kunststoff, weiss
 luminaire pour socle; aluminium, anthracite / plastique, blanc

L 135, B 75, H 400



98269 DONINNI 1

wall light; aluminium, anthracite / plastic, white
 Wandleuchte; Alu, anthrazit / Kunststoff, weiss
 applique; aluminium, anthracite / plastique, blanc

L 135, B 120, H 75

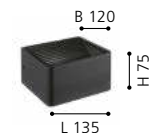



98272 DONINNI 1

floor light; aluminium, anthracite / plastic, white
Stehleuchte; Alu, anthrazit / Kunststoff, weiss
lampadaire; aluminium, anthracite / plastique, blanc

L 135, B 75, H 800

LED

6W

warm
WHITE

600lm



IP44



9 002759 982720



L 135



MODERN



97632 MELZO

pedestal light; cast aluminium, black / plastic, transparent
 Sockelleuchte; Aluguss, schwarz / Kunststoff, transparent
 luminaire pour socle; fonte d'aluminium, noir / plastique, transparent

H 450, Ø 135



1x 11 W
 1x
 950lm



9 002759 976323



97303 MELZO

wall light; cast aluminium, black / plastic, transparent
 Wandleuchte; Aluguss, schwarz / Kunststoff, transparent
 applique; fonte d'aluminium, noir / plastique, transparent

H 130, Ø 135



1x 11 W
 1x
 950lm



9 002759 973032

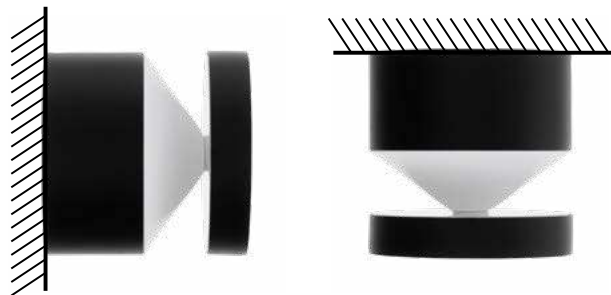

97304 MELZO

floor light; cast aluminium, black / plastic, transparent
 Stehleuchte; Aluguss, schwarz / Kunststoff, transparent
 lampadaire; fonte d'aluminium, noir / plastique, transparent

H 990, Ø 135



1x 11 W
 1x
 950lm



9 002759 973049

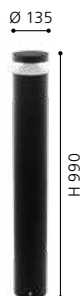

97303

These lamps have diverse uses: They can be installed on the wall or on the ceiling. The lamps variable design also permits floor placement.

Diese Leuchten sind vielseitig einsetzbar: sie können sowohl an der Wand, als auch an der Decke montiert werden. Ebenfalls ist durch das variable Design der Leuchte eine Bodenplatzierung möglich.

Ces luminaires sont d'une application multiple : ils peuvent être aussi bien montés sur le mur qu'attachés au plafond. Un placement au sol est aussi rendu possible par le design variable des luminaires.



97303



97304



98701 DONATORI

wall light; aluminium, plastic, black / glass, clear
Wandleuchte; Alu, Kunststoff, schwarz / Glas, klar
applique; aluminium, plastique, noir / verre, clair

L 155, H 260, A 190



98702 DONATORI

pedestal light; cast aluminium, black / glass, clear
Sockelleuchte; Aluguss, schwarz / Glas, klar
luminaire pour socle; fonte d'aluminium, noir / verre, clair

H 310, Ø 155, Base: Ø 130



98703 DONATORI

floor light; cast aluminium, black / glass, clear
Stehleuchte; Aluguss, schwarz / Glas, klar
lampadaire; fonte d'aluminium, noir / verre, clair

H 990, Ø 155, Base: Ø 130

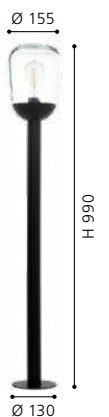
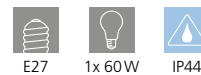

98701



98731 PRATA VECCHIA

wall light; zinc-plated steel, black / plastic, white
Wandleuchte; Stahl verzinkt, schwarz / Kunststoff, weiss
applique; acier galvanisé, noir / plastique, blanc

L 200, H 260, A 285



98732 PRATA VECCHIA

pedestal light; zinc-plated steel, black / plastic, white
Sockelleuchte; Stahl verzinkt, schwarz / Kunststoff, weiss
luminaire pour socle; acier galvanisé, noir / plastique, blanc

L 320, B 200, H 450, Base: B 220, T 40



98733 PRATA VECCHIA

floor light; zinc-plated steel, black / plastic, white
Stehleuchte; Stahl verzinkt, schwarz / Kunststoff, weiss
lampadaire; acier galvanisé, noir / plastique, blanc

L 320, B 200, H 850, Base: B 220, T 40

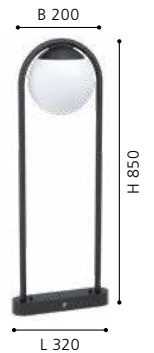



97147 CALDIERO

floor light; zinc-plated steel, anthracite / plastic, white
 Stehleuchte; Stahl verzinkt, anthrazit / Kunststoff, weiss
 lampadaire; acier galvanisé, anthracite / plastique, blanc

L 240, B 140, H 965, Base: Ø 140

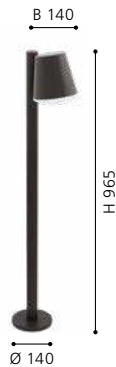

97451 CALDIERO

wall light; zinc-plated steel, anthracite / plastic, white
 Wandleuchte; Stahl verzinkt, anthrazit / Kunststoff, weiss
 applique; acier galvanisé, anthracite / plastique, blanc

L 140, H 240, A 185



97453 CALDIERO

wall light; stainless steel, stainless steel / plastic, white
 Wandleuchte; Edelstahl, edelstahl / Kunststoff, weiss
 applique; acier inoxydable, acier inoxydable / plastique, blanc

L 140, H 240, A 185



97146 CALDIERO

wall light; zinc-plated steel, anthracite / plastic, white
 Wandleuchte; Stahl verzinkt, anthrazit / Kunststoff, weiss
 applique; acier galvanisé, anthracite / plastique, blanc

L 140, H 240, A 185





94277 BASALGO 1

wall light; stainless steel, stainless steel / plastic, clear, white
 Wandleuchte; Edelstahl, edelstahl / Kunststoff, klar, weiss
 applique; acier inoxydable, acier inoxydable / plastique, clair, blanc

L 105, H 180, A 210



1x 3,7W 1x 320lm



94278 BASALGO 1

floor light; stainless steel, stainless steel / plastic, clear, white
 Stehleuchte; Edelstahl, edelstahl / Kunststoff, klar, weiss
 lampadaire; acier inoxydable, acier inoxydable / plastique, clair, blanc

H 450, Ø 105



1x 3,7W 1x 320lm

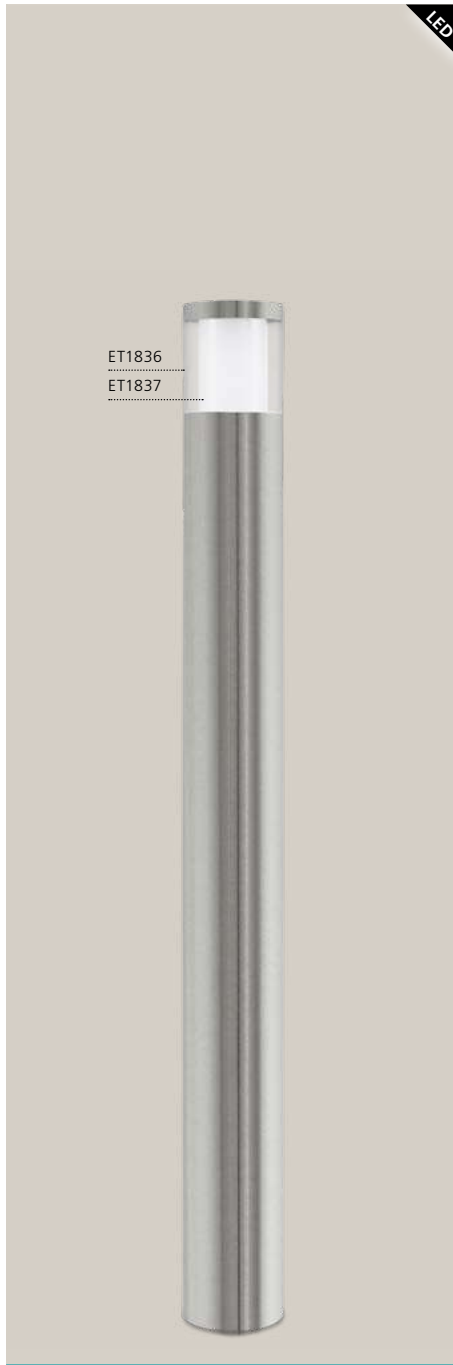

94279 BASALGO 1

floor light; stainless steel, stainless steel / plastic, clear, white
 Stehleuchte; Edelstahl, edelstahl / Kunststoff, klar, weiss
 lampadaire; acier inoxydable, acier inoxydable / plastique, clair, blanc

H 1050, Ø 105



1x 3,7W 1x 320lm

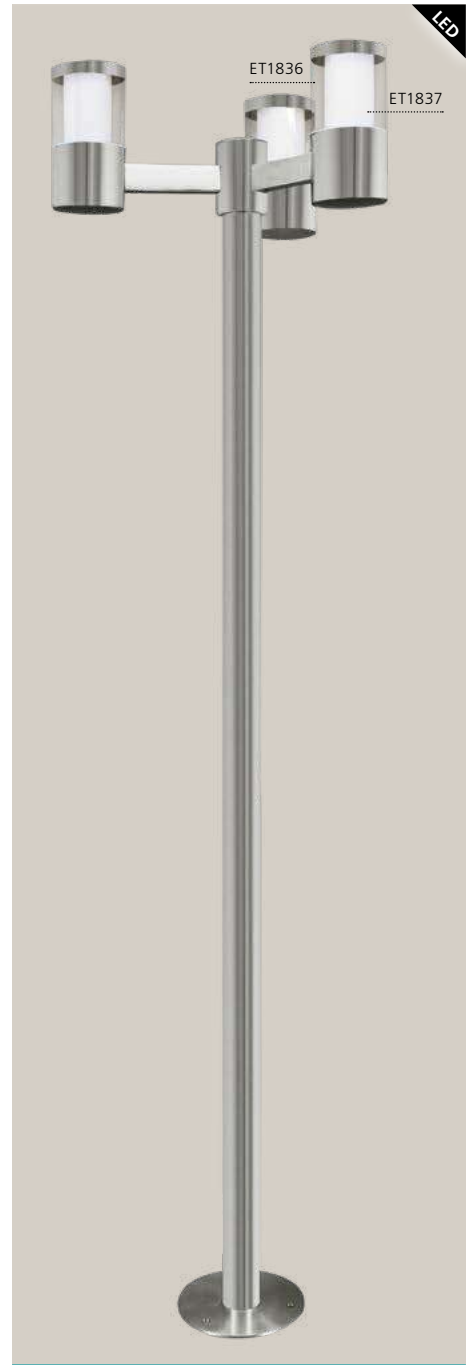

94281 BASALGO 1

floor light; stainless steel, stainless steel / plastic, clear, white
 Stehleuchte; Edelstahl, edelstahl / Kunststoff, klar, weiss
 lampadaire; acier inoxydable, acier inoxydable / plastique, clair, blanc

H 1900, Ø 490, Base: Ø 205



3x 3,7W 3x 320lm

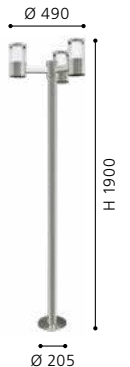

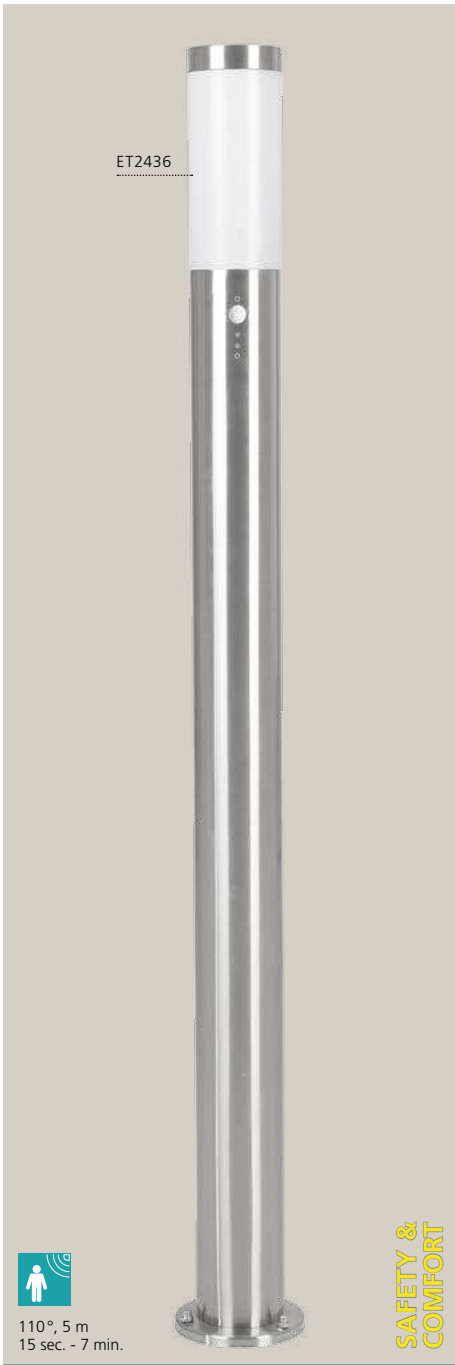

ET2436



110°, 5 m
15 sec. - 7 min.

**SAFETY &
COMFORT**

83281 HELSINKI

floor light; stainless steel, stainless steel / plastic, white
Stehleuchte; Edelstahl, edelstahl / Kunststoff, weiss
lampadaire; acier inoxydable, acier inoxydable / plastique, blanc

H 1100, Ø 75, Base: Ø 115



E27



1x 12W



IP44

Ø 75

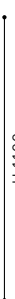

H 1100

Ø 115



9 002759 832810



ET2436



ET2436



110°, 5 m
15 sec. - 7 min.

**SAFETY &
COMFORT**

83279 HELSINKI

floor light; stainless steel, stainless steel / plastic, white
Stehleuchte; Edelstahl, edelstahl / Kunststoff, weiss
lampadaire; acier inoxydable, acier inoxydable / plastique, blanc

H 450, Ø 75, Base: Ø 115



E27



1x 12W



IP44



9 002759 832797

Ø 75



H 450

Ø 115



ET2436

81751 HELSINKI

floor light; stainless steel, stainless steel / plastic, white
Stehleuchte; Edelstahl, edelstahl / Kunststoff, weiss
lampadaire; acier inoxydable, acier inoxydable / plastique, blanc

H 450, Ø 75, Base: Ø 115



E27



1x 12W



IP44

Ø 75

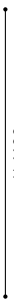

H 1100

Ø 115



9 002759 817510

Ø 75



H 450

Ø 115

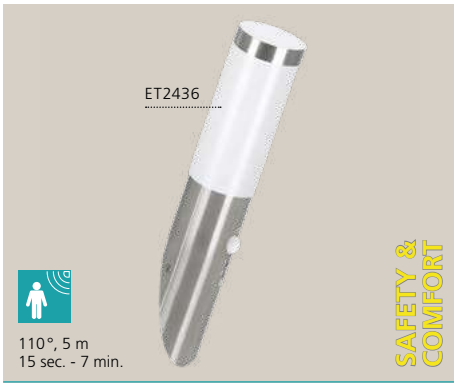

83278 HELSINKI

wall light; stainless steel, stainless steel / plastic, white
Wandleuchte; Edelstahl, edelstahl / Kunststoff, weiss
applique; acier inoxydable, acier inoxydable / plastique, blanc

H 425, Ø 75, A 165



81753 HELSINKI

wall light; stainless steel, stainless steel / plastic, white
Wandleuchte; Edelstahl, edelstahl / Kunststoff, weiss
applique; acier inoxydable, acier inoxydable / plastique, blanc

H 390, Ø 75, A 165





GL2852



GL2852



90°, 8 m
5 sec. - 4 min.

**SAFETY &
COMFORT**



GL2852

27126 NISIA

wall light; stainless steel, stainless steel / glass, white

Wandleuchte; Edelstahl, edelstahl / Glas, weiss

applique; acier inoxydable, acier inoxydable / verre, blanc

L 200, H 355, A 240



E27



1x 60W



IP44



9 002759 271268



30206 NISIA

floor light; stainless steel, stainless steel / satin glass, white

Stehleuchte; Edelstahl, edelstahl / Glas satiniert, weiss

lampadaire; acier inoxydable, acier inoxydable / verre satiné, blanc

H 500, Ø 200, Base: Ø 130



E27



1x 60W



IP44



9 002759 302061



30207 NISIA

floor light; stainless steel, stainless steel / satin glass, white

Stehleuchte; Edelstahl, edelstahl / Glas satiniert, weiss

lampadaire; acier inoxydable, acier inoxydable / verre satiné, blanc

H 1000, Ø 200, Base: Ø 130



E27



1x 60W



IP44



9 002759 302078

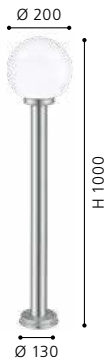

30205 NISIA

wall light; stainless steel, stainless steel / satin glass, white

Wandleuchte; Edelstahl, edelstahl / Glas satiniert, weiss

applique; acier inoxydable, acier inoxydable / verre satiné, blanc

L 200, H 360, A 240



E27



1x 60W



IP44



9 002759 302054



95982 ONCALA

wall light; stainless steel, stainless steel / satin glass, white

Wandleuchte; Edelstahl, edelstahl / Glas satiniert, weiss

applique; acier inoxydable, acier inoxydable / verre satiné, blanc

L 150, H 140, A 190



11W



950lm



IP44



Dimmable



1x 60W



IP44



9 002759 959821





90°, 7 m
10 sec. - 4 min.

**SAFETY &
COMFORT**

95017 POLIENTO

wall light; stainless steel, stainless steel /
plastic, glass, clear, white

Wandleuchte; Edelstahl, edelstahl /
Kunststoff, Glas, klar, weiss

applique; acier inoxydable, acier inoxydable /
plastique, verre, clair, blanc

L 150, H 325, A 195



E27



1x 40W



IP44



9 002759 950170



95016 POLIENTO

wall light; stainless steel, stainless steel /
plastic, glass, clear, white

Wandleuchte; Edelstahl, edelstahl /
Kunststoff, Glas, klar, weiss

applique; acier inoxydable, acier inoxydable /
plastique, verre, clair, blanc

L 150, H 325, A 195



E27



1x 40W



IP44



9 002759 950163



95016



94871 SONELLA

wall / ceiling light; plastic, white / plastic, white

Wand- / Deckenleuchte; Kunststoff, weiss / Kunststoff, weiss

applique / plafonnier; plastique, blanc / plastique, blanc

L 215, H 215, A 70



8,2W 820lm

IP44



94872 SONELLA

wall / ceiling light; plastic, anthracite / plastic, white

Wand- / Deckenleuchte; Kunststoff, anthrazit / Kunststoff, weiss

applique / plafonnier; plastique, anthracite / plastique, blanc

L 215, H 215, A 70



8,2W 820lm

IP44



96494 ARGOLIS

wall / ceiling light; cast aluminium, white / plastic, white

Wand- / Deckenleuchte; Aluguss, weiss / Kunststoff, weiss

applique / plafonnier; fonte d'aluminium, blanc / plastique, blanc

L 300, B 300, H 40



22W 2600lm

IP44



9 002759 948719



9 002759 948726



9 002759 964948



96495



96495 ARGOLIS

wall / ceiling light; cast aluminium, anthracite / plastic, white

Wand- / Deckenleuchte; Aluguss, anthrazit / Kunststoff, weiss

applique / plafonnier; fonte d'aluminium, anthracite / plastique, blanc

L 300, B 300, H 40



22W 2600lm

IP44



9 002759 964955

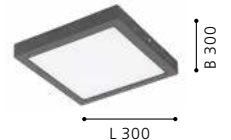



ET2173

94877 INFESTO 1

wall / ceiling light; stainless steel, plastic, stainless steel, silver / plastic, white

Wand- / Deckenleuchte; Edelstahl, Kunststoff, edelstahl, silber / Kunststoff, weiss

applique / plafonnier; acier inoxydable, plastique, acier inoxydable, argent / plastique, blanc

L 250, H 250, A 70

LED

8,2W

warm
WHITE

820lm



IP44



9 002759 948771

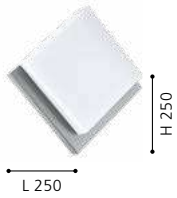

H 250

L 250



94877



96365 VENTO 2

wall / ceiling light; stainless steel, stainless steel / plastic, white

Wand- / Deckenleuchte; Edelstahl, edelstahl / Kunststoff, weiss

applique / plafonnier; acier inoxydable, acier inoxydable / plastique, blanc

Ø 185, A 70



1x 5,4W
1x
410lm



9 002759 963651



Ø 185



94121 VENTO 1

wall / ceiling light; stainless steel, stainless steel / glass, white painted

Wand- / Deckenleuchte; Edelstahl, edelstahl / Glas, weiss lackiert

applique / plafonnier; acier inoxydable, acier inoxydable / verre, blanc laqué

Ø 285, A 80



11W
950lm



9 002759 941215



Ø 285



97254 PILONE

wall / ceiling light; steel, plastic, white / plastic, white

Wand- / Deckenleuchte; Stahl, Kunststoff, weiss / Kunststoff, weiss

applique / plafonnier; acier, plastique, blanc / plastique, blanc

H 70, Ø 300



1x 11W
1x
950lm



9 002759 972547

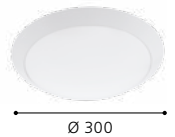

Ø 300



98712 MONGODIO

wall / ceiling light; zinc-plated steel, anthracite / plastic, white

Wand- / Deckenleuchte; Stahl verzinkt, anthrazit / Kunststoff, weiss

applique / plafonnier; acier galvanisé, anthracite / plastique, blanc

H 40, Ø 250



11,5W
1450lm



9 002759 987121



H 40



98712



LED

99585 EREDITA

wall light; stainless steel, plastic, anthracite / satin glass, white
Wandleuchte; Edelstahl, Kunststoff, anthrazit / Glas satiniert, weiss
applique; acier inoxydable, plastique, anthracite / verre satiné, blanc

L 180, H 260, A 105



9 002759 995850



LED

93438 NADELA

wall light; stainless steel, stainless steel / satin glass, white
Wandleuchte; Edelstahl, edelstahl / Glas satiniert, weiss
applique; acier inoxydable, acier inoxydable / verre satiné, blanc

L 215, H 290, A 90



9 002759 934385

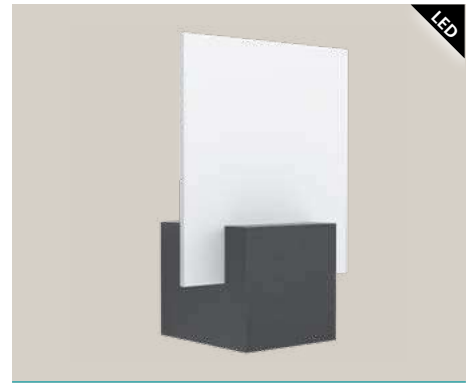

LED

98745 ADAMELLO

wall light; cast aluminium, black / satin glass, white
Wandleuchte; Aluguss, schwarz / Glas satiniert, weiss
applique; fonte d'aluminium, noir / verre satiné, blanc

L 200, H 280, A 130



9 002759 987459



98717



LED

93254 KIBEA

wall light; zinc-plated steel, white, anthracite
Wandleuchte; Stahl verzinkt, weiss, anthrazit
applique; acier galvanisé, blanc, anthracite

L 150, H 260, A 75



9 002759 932541



LED

98717 ALBENZA

wall light; cast aluminium, white, anthracite
Wandleuchte; Aluguss, weiss, anthrazit
applique; fonte d'aluminium, blanc, anthracite

L 200, H 300, A 95



9 002759 987176





95987



95988 SITIA

wall light; zinc-plated steel, anthracite / plastic, white
Wandleuchte; Stahl verzinkt, anthrazit / Kunststoff, weiss
applique; acier galvanisé, anthracite / plastique, blanc

L 180, H 180, A 55



2x 4,8W



2x
550lm



IP44



9 002759 959883

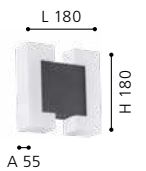

95987 SITIA

wall light; zinc-plated steel, satin nickel / plastic, white
Wandleuchte; Stahl verzinkt, nickel-matt / Kunststoff, weiss
applique; acier galvanisé, nickel mat / plastique, blanc

L 180, H 180, A 55



2x 4,8W



2x
550lm



IP44



9 002759 959876

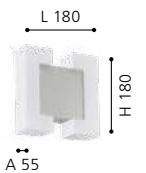



96255



96256 JORBA

wall light; cast aluminium, anthracite / plastic, white
Wandleuchte; Aluguss, anthrazit / Kunststoff, weiss
applique; fonte d'aluminium, anthracite / plastique, blanc

L 110, H 110, A 110



96255 JORBA

wall light; cast aluminium, white / plastic, white
Wandleuchte; Aluguss, weiss / Kunststoff, weiss
applique; fonte d'aluminium, blanc / plastique, blanc

L 110, H 110, A 110

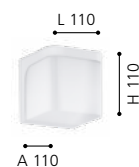



98233 FRANCARI

wall light; cast aluminium, anthracite / plastic, white
 Wandleuchte; Aluguss, anthrazit / Kunststoff, weiss
 applique; fonte d'aluminium, anthracite / plastique, blanc

L 220, H 275, A 225

LED
 warm WHITE
 1x 11 W
 1x 1000lm

IP44



97307 PERNATE

wall light; cast aluminium, anthracite / plastic, white

Wandleuchte; Aluguss, anthrazit / Kunststoff, weiss

applique; fonte d'aluminium, anthracite / plastique, blanc

L 250, H 235, A 170

LED
 warm WHITE
 11 W
 1250lm

IP44

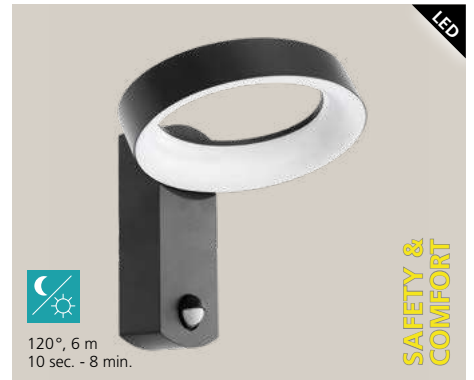

97308 PERNATE

wall light; cast aluminium, anthracite / plastic, white

Wandleuchte; Aluguss, anthrazit / Kunststoff, weiss

applique; fonte d'aluminium, anthracite / plastique, blanc

L 250, H 235, A 170

LED
 warm WHITE
 11 W
 1250lm

IP44



98233



94779 BOSARO

wall light; stainless steel, stainless steel

Wandleuchte; Edelstahl, edelstahl

applique; acier inoxydable, acier inoxydable

L 170, H 270, A 105

LED
 warm WHITE
 2x 2,5 W
 180lm

IP44





LED

93368 REDONDO

wall light; cast aluminium, anthracite
Wandleuchte; Aluguss, anthrazit
applique; fonte d'aluminium, anthracite

L 160, H 175, A 125



2x 2,5W 2x 180lm



IP44



9 002759 933685

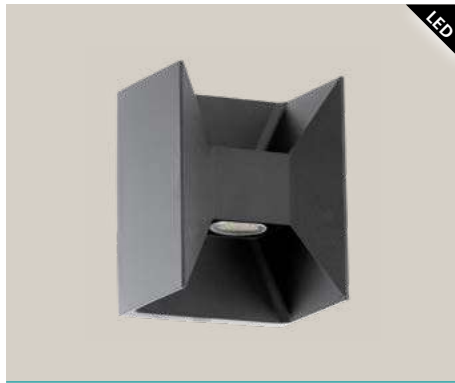

LED

93319 MORINO

wall light; cast aluminium, anthracite
Wandleuchte; Aluguss, anthrazit
applique; fonte d'aluminium, anthracite

L 140, H 180, A 105



2x 2,5W 2x 180lm



IP44



9 002759 933197

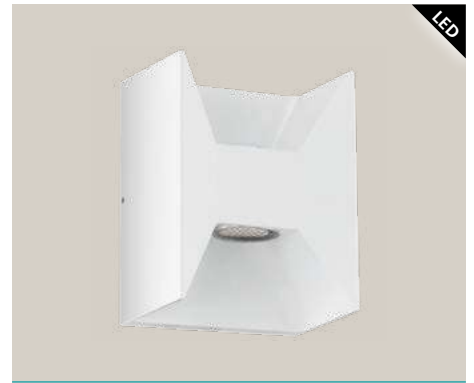
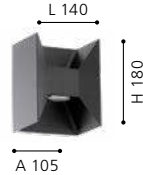

LED

93318 MORINO

wall light; cast aluminium, white
Wandleuchte; Aluguss, weiss
applique; fonte d'aluminium, blanc

L 140, H 180, A 105



2x 2,5W 2x 180lm



IP44



9 002759 933180

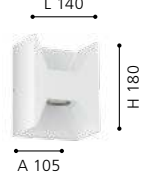

LED

97222 GORZANO

wall light; zinc-plated steel, anthracite / plastic, satined
Wandleuchte; Stahl verzinkt, anthrazit / Kunststoff, satiniert
applique; acier galvanisé, anthracite / plastique, satiné

L 80, H 290, A 105



1x 4,8W 500lm



IP44



9 002759 972226

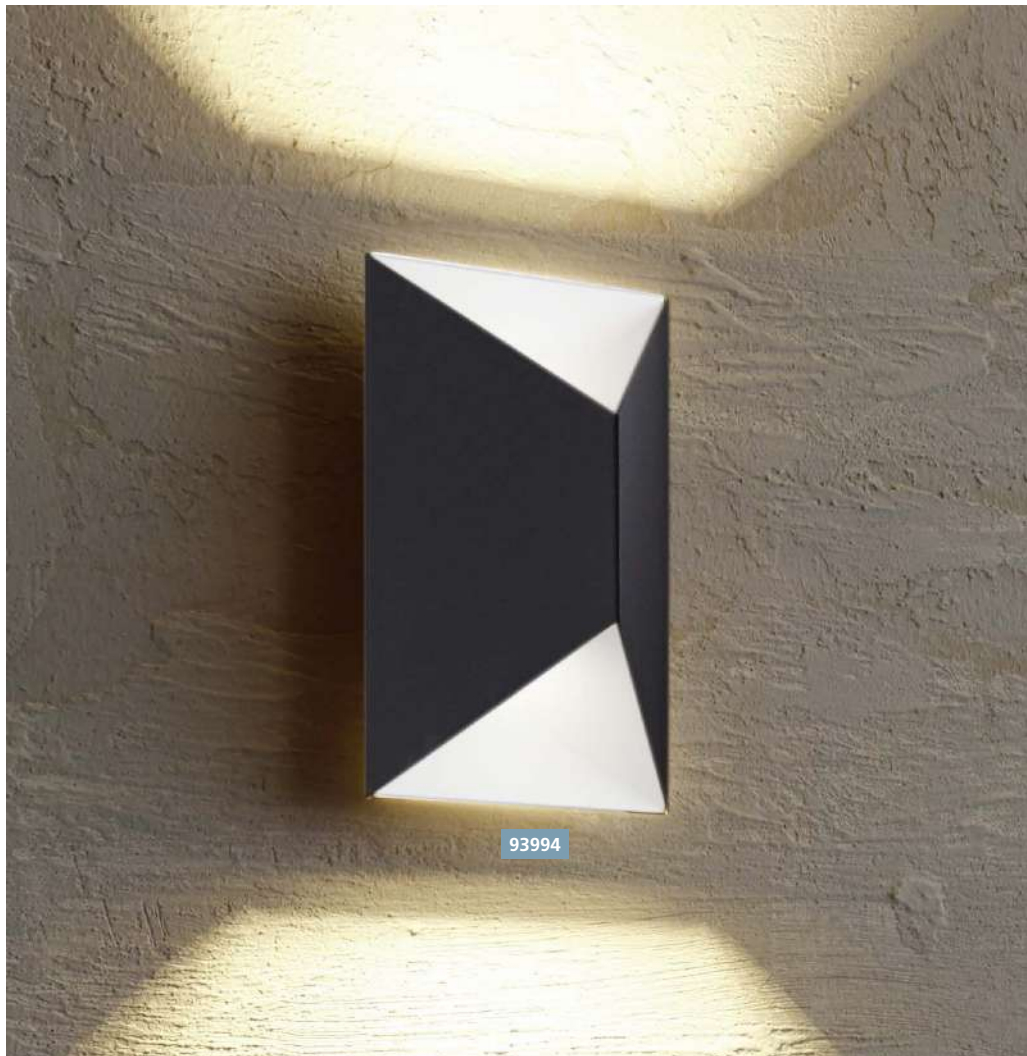

93994



96013 ROBLEDO

wall light; stainless steel, stainless steel / plastic, transparent
 Wandleuchte; Edelstahl, edelstahl / Kunststoff, transparent
 applique; acier inoxydable, acier inoxydable / plastique, transparent

L 75, H 260, A 120



86541 BEVERLY

wall light; stainless steel, stainless steel, silver / satin glass, white
 Wandleuchte; Edelstahl, edelstahl, silber / Glas satiniert, weiss
 applique; acier inoxydable, acier inoxydable, argent / verre satiné, blanc

L 200, H 350, A 135



93268 STOCKHOLM 1

wall light; stainless steel, stainless steel / glass, clear
 Wandleuchte; Edelstahl, edelstahl / Glas, klar
 applique; acier inoxydable, acier inoxydable / verre, clair

Ø 100





94803



94804 AGOLADA

wall light; zinc-plated steel, black, copper
Wandleuchte; Stahl verzinkt, schwarz, kupfer
applique; acier galvanisé, noir, cuivre

L 75, H 360, A 110



2x 3,7W



2x
320lm



IP44



9 002759 948047



94803 AGOLADA

wall light; stainless steel, stainless steel, white
Wandleuchte; Edelstahl, edelstahl, weiss
applique; acier inoxydable, acier inoxydable, blanc

L 75, H 360, A 110



2x 3,7W



2x
320lm



IP44



9 002759 948030



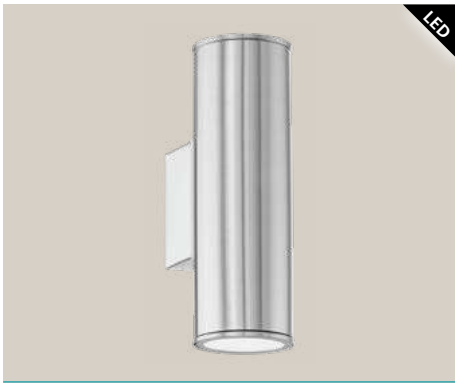

LED

94107 RIGA

wall light; stainless steel, stainless steel
Wandleuchte; Edelstahl, edelstahl
applique; acier inoxydable, acier inoxydable

L 65, H 200, A 95

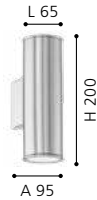
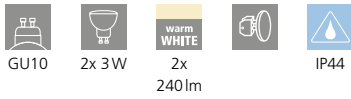

LED

94103 RIGA

wall light; zinc-plated steel, anthracite
Wandleuchte; Stahl verzinkt, anthrazit
applique; acier galvanisé, anthracite

L 65, H 200, A 95

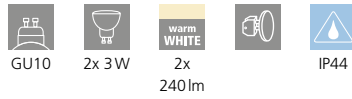

LED

94105 RIGA

wall light; zinc-plated steel, antique-brown
Wandleuchte; Stahl verzinkt, antik-braun
applique; acier galvanisé, marron antique

L 65, H 200, A 95

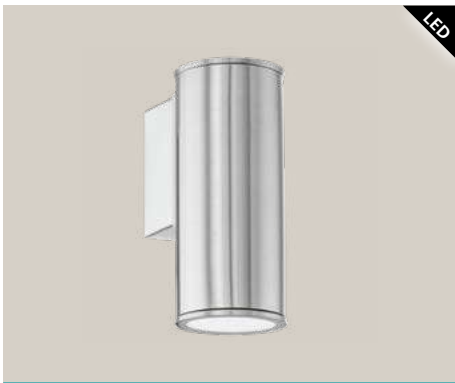
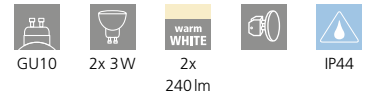

LED

94106 RIGA

wall light; stainless steel, stainless steel
Wandleuchte; Edelstahl, edelstahl
applique; acier inoxydable, acier inoxydable

L 65, H 150, A 95

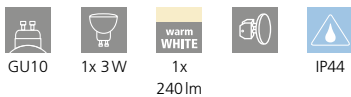

LED

94102 RIGA

wall light; zinc-plated steel, anthracite
Wandleuchte; Stahl verzinkt, anthrazit
applique; acier galvanisé, anthracite

L 65, H 150, A 95

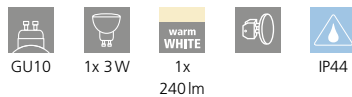

LED

94101 RIGA

wall light; zinc-plated steel, white
Wandleuchte; Stahl verzinkt, weiss
applique; acier galvanisé, blanc

L 65, H 200, A 95

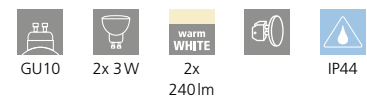



97119 TONEGO

wall light; zinc-plated steel, anthracite / plastic, white
Wandleuchte; Stahl verzinkt, anthrazit / Kunststoff, weiss
applique; acier galvanisé, anthracite / plastique, blanc

L 75, H 310, A 100



92736 RIGA-LED

wall light; stainless steel, stainless steel / plastic, satiné
Wandleuchte; Edelstahl, edelstahl / Kunststoff, satiniert
applique; acier inoxydable, acier inoxydable / plastique, satiné

L 65, H 205, A 95

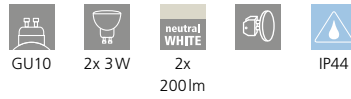

96505 RIGA-LED

wall light; zinc-plated steel, black / plastic, satiné
Wandleuchte; Stahl verzinkt, schwarz / Kunststoff, satiniert
applique; acier galvanisé, noir / plastique, satiné

L 65, H 205, A 100

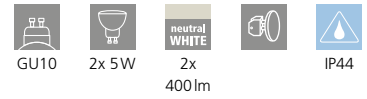

97119



96021 SESIMBA 1

wall light; zinc-plated steel, black / plastic, clear
Wandleuchte; Stahl verzinkt, schwarz / Kunststoff, klar
applique; acier galvanisé, noir / plastique, clair

L 130, H 195, A 140

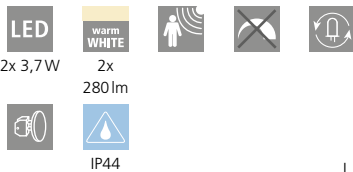

96019 SESIMBA 1

wall light; zinc-plated steel, silver / plastic, clear
Wandleuchte; Stahl verzinkt, silber / Kunststoff, klar
applique; acier galvanisé, argent / plastique, clair

L 130, H 195, A 140

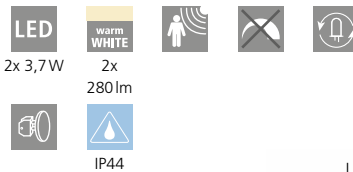

96022 SESIMBA 1

wall light; zinc-plated steel, white / plastic, clear
Wandleuchte; Stahl verzinkt, weiss / Kunststoff, klar
applique; acier galvanisé, blanc / plastique, clair

L 130, H 195, A 140

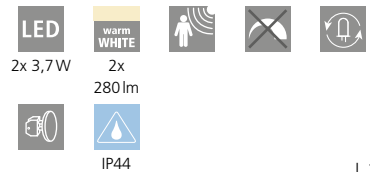

94848 SESIMBA

wall light; zinc-plated steel, black / plastic, clear
Wandleuchte; Stahl verzinkt, schwarz / Kunststoff, klar
applique; acier galvanisé, noir / plastique, clair

L 130, H 195, A 140

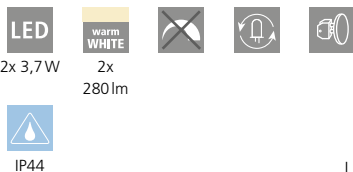

94796 SESIMBA

wall light; zinc-plated steel, silver / plastic, clear
Wandleuchte; Stahl verzinkt, silber / Kunststoff, klar
applique; acier galvanisé, argent / plastique, clair

L 130, H 195, A 140

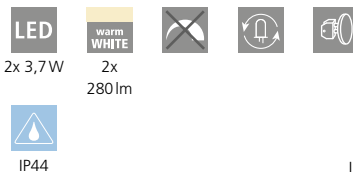



90°, 7 m
10 sec. - 4 min.

**SAFETY &
COMFORT**

97238 VERRES

wall light; stainless steel, plastic, stainless steel, white / plastic, white

Wandleuchte; Edelstahl, Kunststoff, edelstahl, weiss / Kunststoff, weiss

applique; acier inoxydable, plastique, acier inoxydable, blanc / plastique, blanc

L 180, H 290, A 90



E27 1x 12W IP44



9 002759 972387



GL-803

83433 PARK

wall light; cast aluminium, anthracite / satin glass, white

Wandleuchte; Aluguss, anthrazit / Glas satiniert, weiss

applique; fonte d'aluminium, anthracite / verre satiné, blanc

L 200, H 350, A 145



E27 1x 60W IP44



9 002759 834333



LED

94138 BREGANZO

wall light; zinc-plated steel, anthracite / plastic, white

Wandleuchte; Stahl verzinkt, anthrazit / Kunststoff, weiss

applique; acier galvanisé, anthracite / plastique, blanc

L 180, H 250, A 115



LED warm WHITE 2x 2,5W 2x 180lm IP44



9 002759 941383



180°, 7 m
10 sec. - 15 min.

**SAFETY &
COMFORT**

97218 MUSSOTTO

wall light; stainless steel, plastic, stainless steel, white / plastic, white

Wandleuchte; Edelstahl, Kunststoff, edelstahl, weiss / Kunststoff, weiss

applique; acier inoxydable, plastique, acier inoxydable, blanc / plastique, blanc

L 210, H 305, A 90



E27 1x 28W IP44



9 002759 972189



90°, 6 m
10 sec. - 10 min.

**SAFETY &
COMFORT**

96018 BREGANZO 1

wall light; zinc-plated steel, anthracite / plastic, white

Wandleuchte; Stahl verzinkt, anthrazit / Kunststoff, weiss

applique; acier galvanisé, anthracite / plastique, blanc

L 190, H 300, A 125



LED warm WHITE 2x 2,5W 2x 180lm IP44



9 002759 960186



90°, 6 m
10 sec. - 10 min.

**SAFETY &
COMFORT**

96017 BREGANZO 1

wall light; zinc-plated steel, silver / plastic, white

Wandleuchte; Stahl verzinkt, silber / Kunststoff, weiss

applique; acier galvanisé, argent / plastique, blanc

L 190, H 300, A 125



LED warm WHITE 2x 2,5W 2x 180lm IP44



9 002759 960179





89768 ONJA

wall light; cast aluminium, white / glass fluted, clear
Wandleuchte; Aluguss, weiss / Glas geriffelt, klar
applique; fonte d'aluminium, blanc / verre cannelé, clair

L 220, H 155, A 150



89767 ONJA

wall light; cast aluminium, black / glass fluted, clear
Wandleuchte; Aluguss, schwarz / Glas geriffelt, klar
applique; fonte d'aluminium, noir / verre cannelé, clair

L 220, H 155, A 150



90867 LEPUS

wall light; steel, zinc-plated / plastic, white
Wandleuchte; Stahl, feuerverzinkt / Kunststoff, weiss
applique; acier, galvanisé à chaud / plastique, blanc

L 235, H 120, A 125



89768

ONJA

With direct and indirect light this luminaire creates a spectacular effect.

Diese Leuchten schaffen durch direktes und indirektes Licht einen tollen Effekt.

Ce luminaire crée un effet lumineux special pour une illumination directe et indirecte.



96206 ENTRIMO

wall light; zinc-plated steel, zinc-plated / plastic, white
Wandleuchte; Stahl verzinkt, feuerverzinkt / Kunststoff, weiss
applique; acier galvanisé, galvanisé à chaud / plastique, blanc

L 200, H 185, A 235

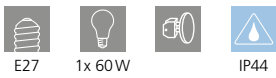

88119 SEVILLA

wall / ceiling light; steel, zinc-plated / satin glass, white
Wand- / Deckenleuchte; Stahl, feuerverzinkt / Glas satiniert, weiss

applique / plafonnier; acier, galvanisé à chaud / verre satiné, blanc

Ø 285, A 83



88489, 88119, 96206, 90867

15 years guarantee against corrosion on the hot dipped galvanized surface.

15 Jahre Garantie gegen Korrosion der feuerverzinkten Oberfläche.

Garantie de 15 ans contre la corrosion de la surface galvanisée à chaud.



88489 MILTON

wall light; steel, zinc-plated / glass, clear
Wandleuchte; Stahl, feuerverzinkt / Glas, klar
applique; acier, galvanisé à chaud / verre, clair

H 310, A 310

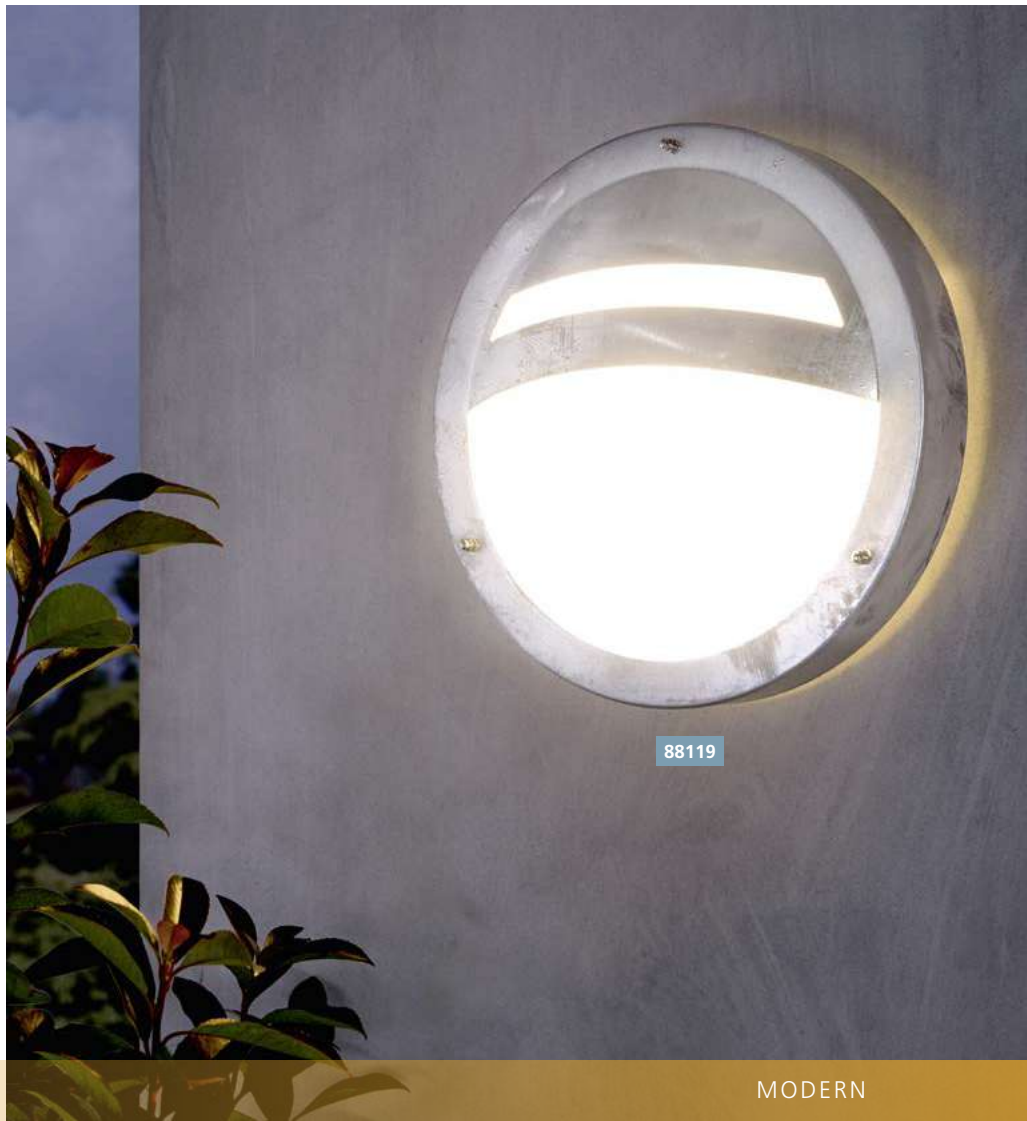

88119



95097 DESELLA 1

wall light; cast aluminium, anthracite / plastic, white
Wandleuchte; Aluguss, anthrazit / Kunststoff, weiss
applique; fonte d'aluminium, anthracite / plastique, blanc

L 160, H 160, A 190

LED

10W

warm
WHITE

900lm



IP54



9 002759 950972



95097



94799 BEVERLY 1

wall light; stainless steel, stainless steel / plastic, white, clear
 Wandleuchte; Edelstahl, edelstahl / Kunststoff, weiss, klar
 applique; acier inoxydable, acier inoxydable / plastique, blanc, clair

L 200, H 270, A 130

- LED
2x 3,7W
- warm WHITE
2x 280lm
-
-
- IP44



95079 BRIONES

wall light; cast aluminium, stainless steel / plastic, white
 Wandleuchte; Aluguss, edelstahl / Kunststoff, weiss
 applique; fonte d'aluminium, acier inoxydable / plastique, blanc

L 85, H 95, A 125

- LED
2x 3W
- warm WHITE
500lm
-
-
- IP44

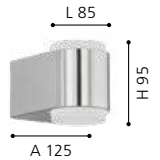

94799



97297 CHEIRA

wall light; cast aluminium, silver / plastic, white
 Wandleuchte; Aluguss, silber / Kunststoff, weiss
 applique; fonte d'aluminium, argent / plastique, blanc

L 295, H 300, A 60

- LED
2x 2,7W
- warm WHITE
2x 300lm
- LED
1x 3,6W
- warm WHITE
1x 430lm
-
-
- IP44

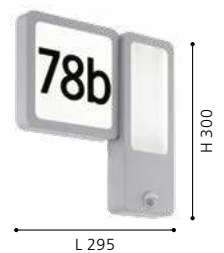

SAFETY & COMFORT

120°, 6 m
10 sec. - 8 min.



OVERVIEW

CLASSIC





98715 CASCINETTA

floor light; cast aluminium, black / glass, clear
 Stehleuchte; Aluguss, schwarz / Glas, klar
 lampadaire; fonte d'aluminium, noir / verre, clair

L 150, B 150, H 795



98713 CASCINETTA

wall light; zinc-plated steel, black / glass, clear
 Wandleuchte; Stahl verzinkt, schwarz / Glas, klar
 applique; acier galvanisé, noir / verre, clair

L 165, H 280, A 165



98714 CASCINETTA

pedestal light; cast aluminium, black / glass, clear
 Sockelleuchte; Aluguss, schwarz / Glas, klar
 luminaire pour socle; fonte d'aluminium, noir / verre, clair

L 150, H 305, A 150





94833 ALAMONTE 1

floor light; zinc-plated steel, black / glass, clear
 Stehleuchte; Stahl verzinkt, schwarz / Glas, klar
 lampadaire; acier galvanisé, noir / verre, clair

L 150, B 150, H 1015, Base: Ø 110



94831 ALAMONTE 1

wall light; zinc-plated steel, black / glass, clear
 Wandleuchte; Stahl verzinkt, schwarz / Glas, klar
 applique; acier galvanisé, noir / verre, clair

L 170, H 260, A 100



99587 ALAMONTE

wall light; steel, black / glass, clear
 Wandleuchte; Stahl, schwarz / Glas, klar
 applique; acier, noir / verre, clair

L 170, H 295, A 100



94832 ALAMONTE 1

wall / ceiling light; zinc-plated steel, black / glass, clear
 Wand- / Deckenleuchte; Stahl verzinkt, schwarz / Glas, klar
 applique / plafonnier; acier galvanisé, noir / verre, clair

L 290, H 290, A 130



98273 ALAMONTE 1

wall light; zinc-plated steel, black / glass, clear
 Wandleuchte; Stahl verzinkt, schwarz / Glas, klar
 applique; acier galvanisé, noir / verre, clair

L 150, H 380, A 100





94788 ALAMONTE 1

pendant light; zinc-plated steel, black / glass, clear
 Hängeleuchte; Stahl verzinkt, schwarz / Glas, klar
 luminaire en suspension; acier galvanisé, noir / verre, clair

L 150, B 150, H 1285



E27



1x 60W



IP44

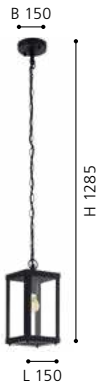

9 002759 947880



99587



98719 MIRANDOLA

wall light; cast aluminium, black / glass, clear
Wandleuchte; Aluguss, schwarz / Glas, klar
applique; fonte d'aluminium, noir / verre, clair

L 180, H 270, A 225

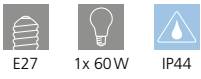

97294 SONCINO

wall light; cast aluminium, black / glass, clear
Wandleuchte; Aluguss, schwarz / Glas, klar
applique; fonte d'aluminium, noir / verre, clair

L 265, H 330, A 120

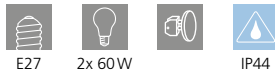

97294



97287 SIRMIONE

floor light; zinc-plated steel, black, gold / glass opal-matt, white
 Stehleuchte; Stahl verzinkt, schwarz, gold / Glas opal-matt, weiss
 lampadaire; acier galvanisé, noir, or / verre opale mat, blanc

L 340, B 270, H 1200, Base: Ø 110

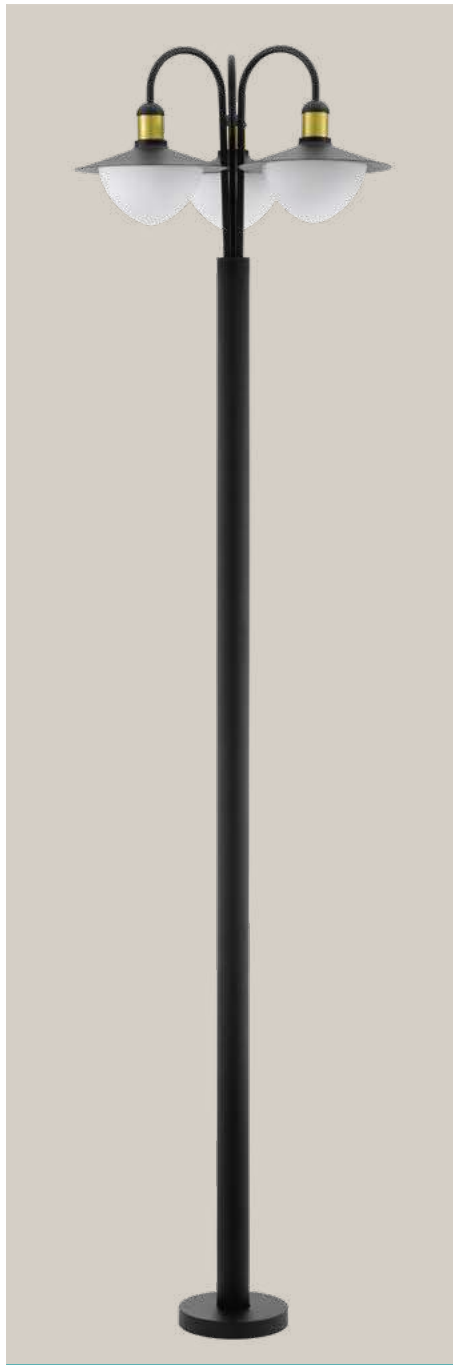

97288 SIRMIONE

floor light; zinc-plated steel, black, gold / glass opal-matt, white
 Stehleuchte; Stahl verzinkt, schwarz, gold / Glas opal-matt, weiss
 lampadaire; acier galvanisé, noir, or / verre opale mat, blanc

H 2200, Ø 550, Base: Ø 200



97285 SIRMIONE

wall light; zinc-plated steel, black, gold / glass opal-matt, white
 Wandleuchte; Stahl verzinkt, schwarz, gold / Glas opal-matt, weiss
 applique; acier galvanisé, noir, or / verre opale mat, blanc

L 270, H 375, A 330

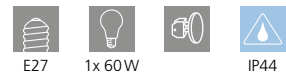

100°, 8 m
 10 sec. - 15 min.

**SAFETY &
 COMFORT**

97286 SIRMIONE

wall light; zinc-plated steel, black, gold / glass opal-matt, white
 Wandleuchte; Stahl verzinkt, schwarz, gold / Glas opal-matt, weiss
 applique; acier galvanisé, noir, or / verre opale mat, blanc

L 270, H 375, A 330

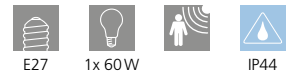



97285

97287

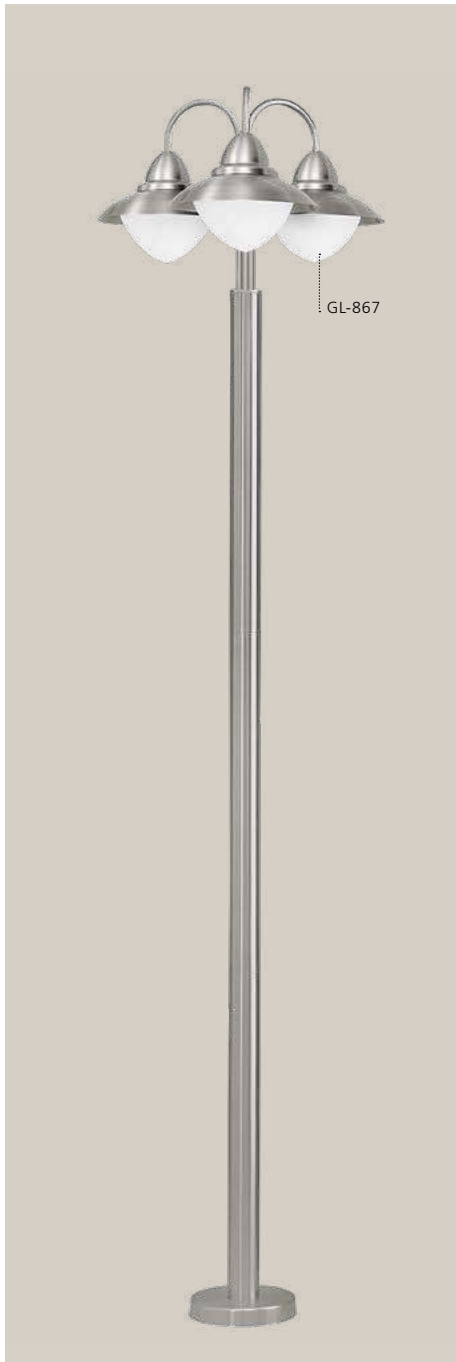

GL-867



GL-867



120°, 6 m
5 sec. - 8 min.

GL-867

**SAFETY &
COMFORT**

83966 SIDNEY

wall light; stainless steel, stainless steel / glass opal-matt, white
Wandleuchte; Edelstahl, edelstahl / Glas opal-matt, weiss
applique; acier inoxydable, acier inoxydable / verre opale mat, blanc

H 375, Ø 270, A 325



E27



1x 60W



IP44



9 002759 839666



87105 SIDNEY

wall light; stainless steel, stainless steel / glass opal-matt, white
Wandleuchte; Edelstahl, edelstahl / Glas opal-matt, weiss
applique; acier inoxydable, acier inoxydable / verre opale mat, blanc

H 375, Ø 270, A 325



E27



1x 60W



IP44



9 002759 871055



83971 SIDNEY

floor light; stainless steel, stainless steel / glass opal-matt, white
Stehleuchte; Edelstahl, edelstahl / Glas opal-matt, weiss
lampadaire; acier inoxydable, acier inoxydable / verre opale mat, blanc

H 2200, Ø 600, Base: Ø 200



E27



3x 60W



IP44

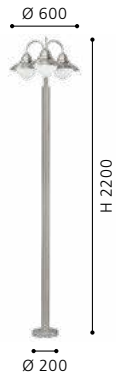

9 002759 839710



30187



99586 TAVERNA

wall light; zinc-plated steel, black / plastic, black-transparent
 Wandleuchte; Stahl verzinkt, schwarz / Kunststoff, schwarz-transparent
 applique; acier galvanisé, noir / plastique, noir transparent

L 200, H 230, A 270



99598 TAVERNA

wall light; zinc-plated steel, black / plastic, transparent
 Wandleuchte; Stahl verzinkt, schwarz / Kunststoff, transparent
 applique; acier galvanisé, noir / plastique, transparent

L 200, H 230, A 270



99155 SOSSANO

wall light; plastic, white / glass with air inclusions, clear
 Wandleuchte; Kunststoff, weiss / Glas mit Lufteneinschlüssen, klar
 applique; plastique, blanc / verre avec inclusions d'air, clair

L 200, H 335, A 210



SAFETY & COMFORT



1



2

99586 & 99598

This luminaires can be mounted upwards or downwards.

Diese Leuchten können aufwärts oder abwärts montiert werden.

Ces luminaires peut être montée vers le haut ou vers le bas.



99598

CLASSIC



94842 HILBURN

wall light; zinc-plated steel, black / plastic, transparent
Wandleuchte; Stahl verzinkt, schwarz / Kunststoff, transparent
applique; acier galvanisé, noir / plastique, transparent

L 200, H 375, A 170

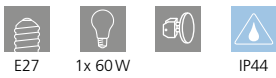

9 002759 948429



94843 HILBURN

wall light; zinc-plated steel, black / plastic, transparent
Wandleuchte; Stahl verzinkt, schwarz / Kunststoff, transparent
applique; acier galvanisé, noir / plastique, transparent

L 200, H 280, A 200

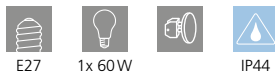

9 002759 948436



94864 HILBURN

pedestal light; zinc-plated steel, black / plastic, transparent
Sockelleuchte; Stahl verzinkt, schwarz / Kunststoff, transparent
luminaire pour socle; acier galvanisé, noir / plastique, transparent

L 200, B 135, H 410, Base: Ø 110

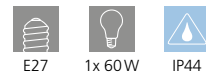

9 002759 948641



94865 HILBURN 1

wall light; zinc-plated steel, silver-antique / plastic, transparent
Wandleuchte; Stahl verzinkt, silber-antik / Kunststoff, transparent
applique; acier galvanisé, argent antique / plastique, transparent

L 200, H 375, A 170



9 002759 948658

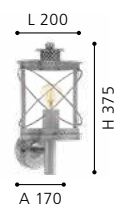

94866 HILBURN 1

wall light; zinc-plated steel, silver-antique / plastic, transparent
Wandleuchte; Stahl verzinkt, silber-antik / Kunststoff, transparent
applique; acier galvanisé, argent antique / plastique, transparent

L 200, H 280, A 200



9 002759 948665

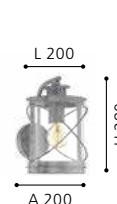



94865



GL3396

94792 MELGOA

wall light; zinc-plated steel, black / glass, clear
Wandleuchte; Stahl verzinkt, schwarz / Glas, klar
applique; acier galvanisé, noir / verre, clair

L 300, H 250, A 380

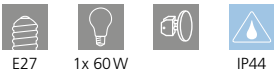

9 002759 947927



ET2397

94805 BARROSELA

wall light; zinc-plated steel, black / plastic, white
Wandleuchte; Stahl verzinkt, schwarz / Kunststoff, weiss
applique; acier galvanisé, noir / plastique, blanc

L 220, H 240, A 230



9 002759 948054



97226 CANOVE

wall light; zinc-plated steel, black / glass, clear, satiné
Wandleuchte; Stahl verzinkt, schwarz / Glas, klar, satiniert
applique; acier galvanisé, noir / verre, clair, satiné

L 230, H 240, A 235

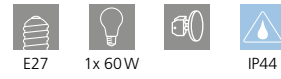

9 002759 972264

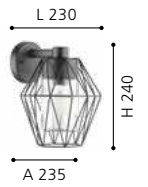

94792



ET2131

94841 PULFERO

wall light; zinc-plated steel, black / plastic, transparent
Wandleuchte; Stahl verzinkt, schwarz / Kunststoff, transparent
applique; acier galvanisé, noir / plastique, transparent

L 220, H 280, A 280

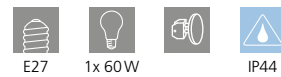

9 002759 948412





94863 MELGOA

wall light; zinc-plated steel, copper-coloured antique / glass, clear
 Wandleuchte; Stahl verzinkt, kupferfarben-antik / Glas, klar
 applique; acier galvanisé, cuivré antique / verre, clair

L 300, H 250, A 380

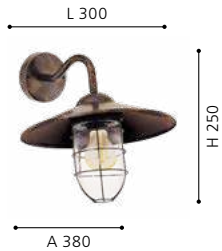
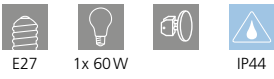

94858 BARROSELA

wall light; zinc-plated steel, copper-coloured antique / plastic, white
 Wandleuchte; Stahl verzinkt, kupferfarben-antik / Kunststoff, weiss

applique; acier galvanisé, cuivré antique / plastique, blanc

L 220, H 240, A 230

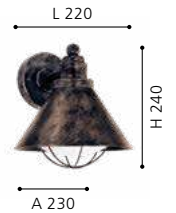
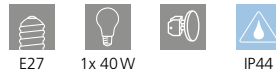

83589 MILTON

wall light; zinc-plated steel, antique-brown / glass, clear
 Wandleuchte; Stahl verzinkt, antik-braun / Glas, klar
 applique; acier galvanisé, marron antique / verre, clair

B 240, H 310, A 300

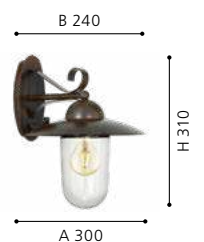
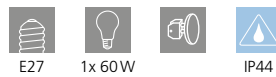



90184 SAN TELMO

wall light; zinc-plated steel, cast aluminium, antique-brown / glass with air inclusions, clear
 Wandleuchte; Stahl verzinkt, Aluguss, antik-braun / Glas mit Lufteingchlüssen, klar
 applique; acier galvanisé, fonte d'aluminium, marron antique / verre avec inclusions d'air, clair

L 180, H 350, A 240

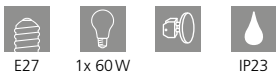

96241 VALDEO

wall light; zinc-plated steel, copper-coloured antique / glass, clear
 Wandleuchte; Stahl verzinkt, kupferfarben-antik / Glas, klar
 applique; acier galvanisé, cuivré antique / verre, clair

L 165, H 275, A 200

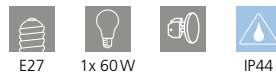

96262 ALBACETE

wall light; zinc-plated steel, brown, copper / glass with air inclusions, clear
 Wandleuchte; Stahl verzinkt, braun, kupfer / Glas mit Lufteingchlüssen, klar
 applique; acier galvanisé, marron, cuivre / verre avec inclusions d'air, clair

L 265, H 255, A 280



94855 PULFERO 1

wall light; zinc-plated steel, brown / plastic, transparent
 Wandleuchte; Stahl verzinkt, braun / Kunststoff, transparent
 applique; acier galvanisé, marron / plastique, transparent

L 220, H 280, A 280





97261 BOVOLONE

wall light; zinc-plated steel, black / glass, clear
Wandleuchte; Stahl verzinkt, schwarz / Glas, klar
applique; acier galvanisé, noir / verre, clair

L 110, H 340, A 155

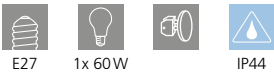

96239 VALDEO

wall light; zinc-plated steel, black / glass, clear
Wandleuchte; Stahl verzinkt, schwarz / Glas, klar
applique; acier galvanisé, noir / verre, clair

L 165, H 275, A 200

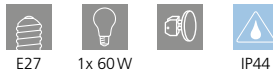

97296 TRECATE

wall light; zinc-plated steel, black / glass, clear
Wandleuchte; Stahl verzinkt, schwarz / Glas, klar
applique; acier galvanisé, noir / verre, clair

L 160, H 355, A 130

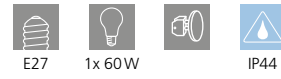

96207 ENTRIMO

wall light; zinc-plated steel, black / plastic, white
Wandleuchte; Stahl verzinkt, schwarz / Kunststoff, weiss
applique; acier galvanisé, noir / plastique, blanc

L 200, H 185, A 235

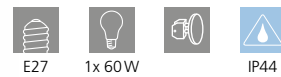



97296





98123 MONREALE

floor light; cast aluminium, black / plastic, transparent
 Stehleuchte; Aluguss, schwarz / Kunststoff, transparent
 lampadaire; fonte d'aluminium, noir / plastique, transparent

H 995, Ø 230, Base: Ø 110

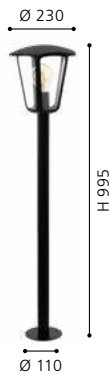

98121 MONREALE

wall light; cast aluminium, black / plastic, transparent
 Wandleuchte; Aluguss, schwarz / Kunststoff, transparent
 applique; fonte d'aluminium, noir / plastique, transparent

L 230, H 275, A 255



98119 MONREALE

wall light; cast aluminium, black / plastic, transparent
 Wandleuchte; Aluguss, schwarz / Kunststoff, transparent
 applique; fonte d'aluminium, noir / plastique, transparent

L 230, H 275, A 255

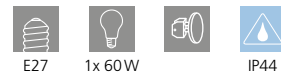

98122 MONREALE

pedestal light; cast aluminium, black / plastic, transparent
 Sockelleuchte; Aluguss, schwarz / Kunststoff, transparent
 luminaire pour socle; fonte d'aluminium, noir / plastique, transparent

H 335, Ø 230, Base: Ø 110





98121



93406 ALORIA

pendant light; cast aluminium, black / plastic, clear
 Hängeleuchte; Aluguss, schwarz / Kunststoff, klar
 luminaire en suspension; fonte d'aluminium, noir / plastique, clair

L 170, B 170, H 685



93409 ALORIA

floor light; cast aluminium, black / plastic, clear
 Stehleuchte; Aluguss, schwarz / Kunststoff, klar
 lampadaire; fonte d'aluminium, noir / plastique, clair

H 1800, Ø 480, Base: Ø 215



93408 ALORIA

floor light; cast aluminium, black / plastic, clear
 Stehleuchte; Aluguss, schwarz / Kunststoff, klar
 lampadaire; fonte d'aluminium, noir / plastique, clair

L 170, B 170, H 940, Base: Ø 170





93097 ALORIA

wall light; cast aluminium, black / plastic, clear
 Wandleuchte; Aluguss, schwarz / Kunststoff, klar
 applique; fonte d'aluminium, noir / plastique, clair

L 170, H 225, A 190

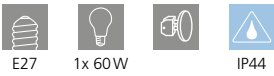

93098 ALORIA

wall light; cast aluminium, black / plastic, clear
 Wandleuchte; Aluguss, schwarz / Kunststoff, klar
 applique; fonte d'aluminium, noir / plastique, clair

L 170, H 225, A 190

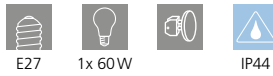

93407 ALORIA

wall light; cast aluminium, black / plastic, clear
 Wandleuchte; Aluguss, schwarz / Kunststoff, klar
 applique; fonte d'aluminium, noir / plastique, clair

L 180, H 200, A 120



93099 ALORIA

pedestal light; cast aluminium, black / plastic, clear
 Sockelleuchte; Aluguss, schwarz / Kunststoff, klar
 luminaire pour socle; fonte d'aluminium, noir / plastique, clair

L 170, B 170, H 300, Base: Ø 170

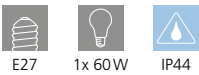



93404 ALORIA

floor light; cast aluminium, white / plastic, clear
 Stehleuchte; Aluguss, weiss / Kunststoff, klar
 lampadaire; fonte d'aluminium, blanc / plastique, clair

L 170, B 170, H 940, Base: Ø 170

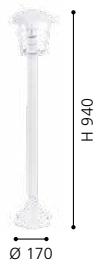

93094 ALORIA

wall light; cast aluminium, white / plastic, clear
 Wandleuchte; Aluguss, weiss / Kunststoff, klar
 applique; fonte d'aluminium, blanc / plastique, clair

L 170, H 225, A 190

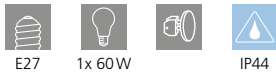

93095 ALORIA

wall light; cast aluminium, white / plastic, clear
 Wandleuchte; Aluguss, weiss / Kunststoff, klar
 applique; fonte d'aluminium, blanc / plastique, clair

L 170, H 225, A 190

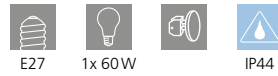

93403 ALORIA

wall light; cast aluminium, white / plastic, clear
 Wandleuchte; Aluguss, weiss / Kunststoff, klar
 applique; fonte d'aluminium, blanc / plastique, clair

L 180, H 200, A 120



93096 ALORIA

pedestal light; cast aluminium, white / plastic, clear
 Sockelleuchte; Aluguss, weiss / Kunststoff, klar
 luminaire pour socle; fonte d'aluminium, blanc / plastique, clair

L 170, B 170, H 300, Base: Ø 170





93403



93456 NAVEDO

wall light; cast aluminium, black, silver-patina / glass, clear
Wandleuchte; Aluguss, schwarz, silber-patina / Glas, klar
applique; fonte d'aluminium, noir, argent patiné / verre, clair

L 200, H 475, A 285

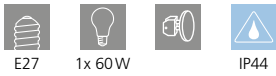

93457 NAVEDO

wall light; cast aluminium, black, silver-patina / glass, clear
Wandleuchte; Aluguss, schwarz, silber-patina / Glas, klar
applique; fonte d'aluminium, noir, argent patiné / verre, clair

L 200, H 475, A 285

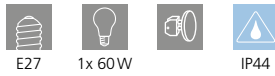

93458 NAVEDO

wall light; cast aluminium, black, silver-patina / glass, clear
Wandleuchte; Aluguss, schwarz, silber-patina / Glas, klar
applique; fonte d'aluminium, noir, argent patiné / verre, clair

L 200, H 425, A 285



93459 NAVEDO

wall light; cast aluminium, black, silver-patina / glass, clear
Wandleuchte; Aluguss, schwarz, silber-patina / Glas, klar
applique; fonte d'aluminium, noir, argent patiné / verre, clair

L 290, H 430, A 130



93462 NAVEDO

pedestal light; cast aluminium, black, silver-patina / glass, clear
Sockelleuchte; Aluguss, schwarz, silber-patina / Glas, klar
luminaire pour socle; fonte d'aluminium, noir, argent patiné / verre, clair

H 470, Ø 230, Base: Ø 170



93455 NAVEDO

pendant light; cast aluminium, black, silver-patina / glass, clear
Hängeleuchte; Aluguss, schwarz, silber-patina / Glas, klar
luminaire en suspension; fonte d'aluminium, noir, argent patiné / verre, clair

H 1045, Ø 230

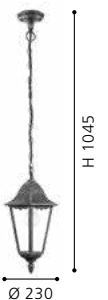



93457





93465 NAVEDO

floor light; cast aluminium, black, silver-patina / glass, clear
 Stehleuchte; Aluguss, schwarz, silber-patina / Glas, klar
 lampadaire; fonte d'aluminium, noir, argent patiné / verre, clair

H 2200, Ø 560, Base: Ø 230



93464 NAVEDO

floor light; cast aluminium, black, silver-patina / glass, clear
 Stehleuchte; Aluguss, schwarz, silber-patina / Glas, klar
 lampadaire; fonte d'aluminium, noir, argent patiné / verre, clair

H 2000, Ø 230, Base: Ø 245



93463 NAVEDO

floor light; cast aluminium, black, silver-patina / glass, clear
 Stehleuchte; Aluguss, schwarz, silber-patina / Glas, klar
 lampadaire; fonte d'aluminium, noir, argent patiné / verre, clair

H 1200, Ø 230, Base: Ø 170





93454 NAVEDO

floor light; cast aluminium, white / glass, clear
 Stehleuchte; Aluguss, weiss / Glas, klar
 lampadaire; fonte d'aluminium, blanc / verre, clair

H 2200, Ø 560, Base: Ø 230



E27 3x 60W IP44



9 002759 934545



93453 NAVEDO

floor light; cast aluminium, white / glass, clear
 Stehleuchte; Aluguss, weiss / Glas, klar
 lampadaire; fonte d'aluminium, blanc / verre, clair

H 2000, Ø 230, Base: Ø 245



E27 1x 60W IP44



9 002759 934538



93452 NAVEDO

floor light; cast aluminium, white / glass, clear
 Stehleuchte; Aluguss, weiss / Glas, klar
 lampadaire; fonte d'aluminium, blanc / verre, clair

H 1200, Ø 230, Base: Ø 170



E27 1x 60W IP44



9 002759 934521



93445 NAVEDO

wall light; cast aluminium, white / glass, clear
Wandleuchte; Aluguss, weiss / Glas, klar
applique; fonte d'aluminium, blanc / verre, clair

L 200, H 475, A 285

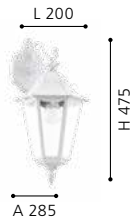
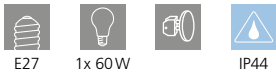

93446 NAVEDO

wall light; cast aluminium, white / glass, clear
Wandleuchte; Aluguss, weiss / Glas, klar
applique; fonte d'aluminium, blanc / verre, clair

L 200, H 475, A 285

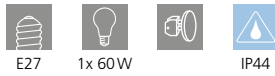

93447 NAVEDO

wall light; cast aluminium, white / glass, clear
Wandleuchte; Aluguss, weiss / Glas, klar
applique; fonte d'aluminium, blanc / verre, clair

L 200, H 425, A 285



93448 NAVEDO

wall light; cast aluminium, white / glass, clear
Wandleuchte; Aluguss, weiss / Glas, klar
applique; fonte d'aluminium, blanc / verre, clair

L 290, H 430, A 130



93451 NAVEDO

pedestal light; cast aluminium, white / glass, clear
Sockelleuchte; Aluguss, weiss / Glas, klar
luminaire pour socle; fonte d'aluminium, blanc / verre, clair

H 470, Ø 230, Base: Ø 170



97258 MANERBIO

wall light; cast aluminium, white / glass, clear
Wandleuchte; Aluguss, weiss / Glas, klar
applique; fonte d'aluminium, blanc / verre, clair

L 240, H 410, A 125





93445



22471 LATERNA 4

pendant light; cast aluminium, black / glass, clear
 Hängeleuchte; Aluguss, schwarz / Glas, klar
 luminaire en suspension; fonte d'aluminium, noir / verre, clair

H 900, Ø 205

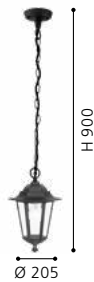
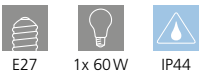

22145 LATERNA 4

floor light; cast aluminium, black / glass, clear
 Stehleuchte; Aluguss, schwarz / Glas, klar
 lampadaire; fonte d'aluminium, noir / verre, clair

H 1920, Ø 550, Base: Ø 260



22144 LATERNA 4

floor light; cast aluminium, black / glass, clear
 Stehleuchte; Aluguss, schwarz / Glas, klar
 lampadaire; fonte d'aluminium, noir / verre, clair

H 1000, Ø 205, Base: Ø 170

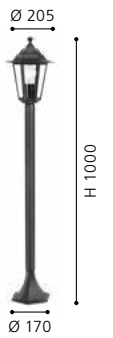



22467 LATERNA 4

wall light; cast aluminium, black / glass, clear
Wandleuchte; Aluguss, schwarz / Glas, klar
applique; fonte d'aluminium, noir / verre, clair

L 165, H 350, A 210

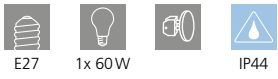

22468 LATERNA 4

wall light; cast aluminium, black / glass, clear
Wandleuchte; Aluguss, schwarz / Glas, klar
applique; fonte d'aluminium, noir / verre, clair

L 165, H 320, A 230

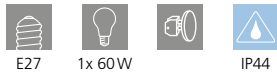

22469 LATERNA 4

wall light; cast aluminium, black / glass, clear
Wandleuchte; Aluguss, schwarz / Glas, klar
applique; fonte d'aluminium, noir / verre, clair

L 165, H 360, A 215



22472 LATERNA 4

pedestal light; cast aluminium, black / glass, clear
Sockelleuchte; Aluguss, schwarz / Glas, klar
luminaire pour socle; fonte d'aluminium, noir / verre, clair

H 385, Ø 195, Base: Ø 170





22996 LATERNA 5

floor light; cast aluminium, white / glass, clear
 Stehleuchte; Aluguss, weiss / Glas, klar
 lampadaire; fonte d'aluminium, blanc / verre, clair

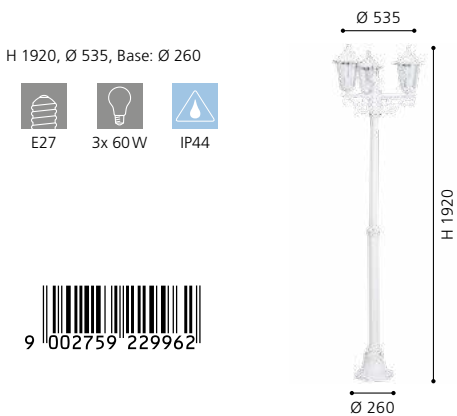

22995 LATERNA 5

floor light; cast aluminium, white / glass, clear
 Stehleuchte; Aluguss, weiss / Glas, klar
 lampadaire; fonte d'aluminium, blanc / verre, clair

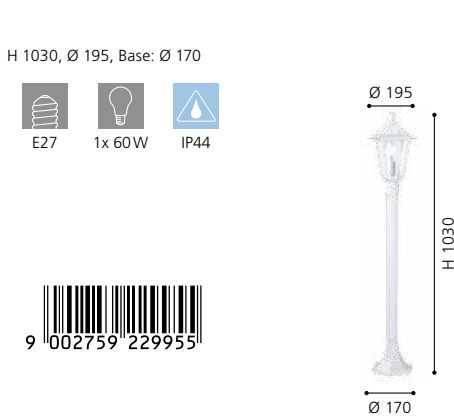

22462 LATERNA 5

wall light; cast aluminium, white / glass, clear
 Wandleuchte; Aluguss, weiss / Glas, klar
 applique; fonte d'aluminium, blanc / verre, clair

L 165, H 350, A 210

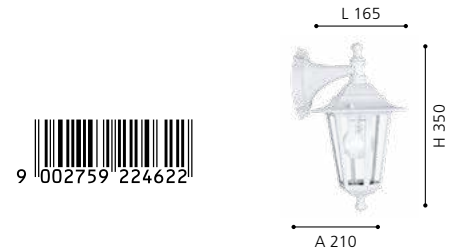
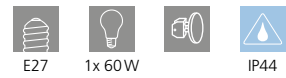

22463 LATERNA 5

wall light; cast aluminium, white / glass, clear
 Wandleuchte; Aluguss, weiss / Glas, klar
 applique; fonte d'aluminium, blanc / verre, clair

L 165, H 320, A 230

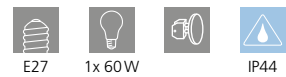



22464 LATERNA 5

wall light; cast aluminium, white / glass, clear
Wandleuchte; Aluguss, weiss / Glas, klar
applique; fonte d'aluminium, blanc / verre, clair

L 165, H 360, A 215



E27



1x 60W



IP44



22466 LATERNA 5

pedestal light; cast aluminium, white / glass, clear
Sockelleuchte; Aluguss, weiss / Glas, klar
luminaire pour socle; fonte d'aluminium, blanc / verre, clair

H 385, Ø 195, Base: Ø 170



E27



1x 60W



IP44







SAFETY & COMFORT

97418 DETECT ME 5

Sensor; plastic, white
Sensor; Kunststoff, weiss
Sensor; plastique, blanc



SAFETY & COMFORT

97419 DETECT ME 5

Sensor; plastic, black
Sensor; Kunststoff, schwarz
Sensor; plastique, noir



806 lm
5 year warranty
Jahre Garantie
ans de garantie
años de garantía

SAFETY & COMFORT

11714 LM_LED_E27E27-LED-A60

Bulb; plastic, opal
Leuchtmittel; Kunststoff, opal
Ampoule; plastique, opale

L 65, H 95, A 35



IP44



9 002759 974183

L 65, H 95, A 35



IP44



9 002759 974190

L 115, Ø 60



E27

1x 9,5 W

3000K

25000h



220-240V, 50/60Hz

15000x

>80

10



9 002759 117146



A+



9,5 W

60 W



DAY & NIGHT
Sensor

DETECT ME 5

Automatic illumination. This photo-electric lighting controller is used for controlling lighting systems for building fronts. It automatically switches light 'ON' at dusk automatically 'OFF' again at dawn. Of course, the light-level threshold at which the sensor responds and turns the light 'ON' is defined by no other than you yourself.

Automatische Beleuchtung. Der Day & Night Sensor dient zur Steuerung von Beleuchtungsanlagen an Hausfronten und schaltet bei Dämmerung automatisch das Licht AN und am Morgen automatisch wieder AUS. Die Dämmerungsschwelle, bei der der Sensor reagiert und die Beleuchtung schaltet, definieren Sie natürlich selbst.

Un éclairage automatique. Un éclairage automatique. L'interrupteur crépusculaire pour la commande des installations d'éclairage pour les façades de maison. Il allume automatiquement la lumière au crépuscule et l'éteint automatiquement à l'aube. C'est naturellement à vous de définir le seuil de luminosité auquel doit réagir le détecteur et allumer la lumière.



DAY & NIGHT
Sensor

11714

Security and Comfort for little money

This bulb has a Day&Night sensor and switches on automatically at dusk or off at dawn. Thanks to the E27 socket the bulb can easily be exchanged for existing luminaires. With an average electricity price of € 0,16/KWh and an average lighting time of 8 hours/day, the costs amount to approx. € 5,00 per year.

Sicherheit und Komfort für wenig Geld

Dieses Leuchtmittel verfügt über einen Day&Night-Sensor und schaltet sich selbständig bei Dunkelheit ein bzw. bei Helligkeit aus. Dank der E27-Fassung kann das Leuchtmittel einfach in bestehende Leuchten getauscht werden. Bei einem durchschnittlichen Strompreis von € 0,16 / KWh und einer durchschnittlichen Leuchtdauer von 8 Stunden/Tag belaufen sich die Kosten auf ca. € 5,00 pro Jahr.

Sécurité et confort pour peu d'argent

Cette ampoule possède un capteur Day & Night et s'allume automatiquement au crépuscule ou à l'aube. Grâce à la prise E27, l'ampoule peut être facilement échangée. Avec un prix moyen de l'électricité de € 0,16 / KWh et un temps d'éclairage moyen de 8 heures / jour, les coûts s'élèvent à env. € 5,00 par an.



97464 DETECT ME 3

motion detector; plastic, white
 Bewegungsmelder; Kunststoff, weiss
 détecteur de mouvement; plastique, blanc

L 100, H 100, A 55

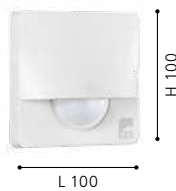

97466 DETECT ME 4

motion detector; plastic, white
 Bewegungsmelder; Kunststoff, weiss
 détecteur de mouvement; plastique, blanc

L 70, H 55, A 100

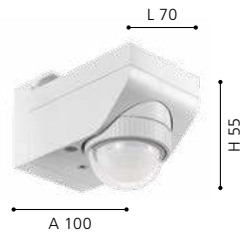

97421 DETECT ME 6

motion detector; plastic, white / plastic, white
 Bewegungsmelder; Kunststoff, weiss / Kunststoff, weiss
 détecteur de mouvement; plastique, blanc / plastique, blanc

Ø 90, A 55

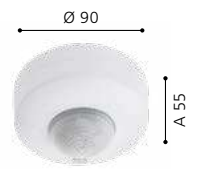

97465 DETECT ME 3

motion detector; plastic, black
 Bewegungsmelder; Kunststoff, schwarz
 détecteur de mouvement; plastique, noir

L 100, H 100, A 55



97467 DETECT ME 4

motion detector; plastic, black
 Bewegungsmelder; Kunststoff, schwarz
 détecteur de mouvement; plastique, noir

L 70, H 55, A 100



97422 DETECT ME 6

motion detector; plastic, black / plastic, white
 Bewegungsmelder; Kunststoff, schwarz / Kunststoff, weiss
 détecteur de mouvement; plastique, noir / plastique, blanc

Ø 90, A 55

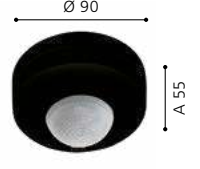



180°, 12 m
10 sec. - 15 min.

**SAFETY &
COMFORT**

96452 DETECT ME 1

motion detector; plastic, white
Bewegungsmelder; Kunststoff, weiss
détecteur de mouvement; plastique, blanc

L 55, H 70, A 80



IP44



9 002759 964528

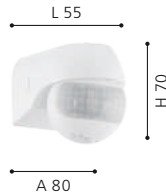

96452



DETECT ME 1

DETECT ME 3

DETECT ME 6

DETECT ME 4



MOUNT ON CEILING



MOUNT ON WALL

		•	•
•	•		•

Accessories incl. / Zubehör inkl. / Accessoires inclus



MOUNT IN CORNER



MOUNT ON CORNER

			•
			included see page 175
10 sec. - 15 min.	10 sec. - 15 min.	10 sec. - 15 min.	10 sec. - 15 min.
12 m	12 m	12 m	12 m
180°	160°	360°	360°
+/- 40° horizontal 45° vertical	+/- 30° horizontal +/- 90° vertical		
3 - 2000 lx	3 - 2000 lx	3 - 2000 lx	3 - 2000 lx
max. 800 W incandescent max. 400 W flourescent	max. 1200 W incandescent max. 300 W flourescent	max. 1200 W incandescent max. 300 W flourescent	max. 1200 W incandescent max. 300 W flourescent



180°, 12 m
10 sec. - 15 min.

**SAFETY &
COMFORT**

96454 DETECT ME 1

motion detector; plastic, black
Bewegungsmelder; Kunststoff, schwarz
détecteur de mouvement; plastique, noir

L 55, H 70, A 80



IP44



9 002759 964542



Ideal mounting height / Ideale Montagehöhe / Hauteur de montage ideale: ~ 2m



93384 NEMA 1

ground spike; plastic, black / plastic, transparent
 Erdspieß; Kunststoff, schwarz / Kunststoff, transparent
 piquet de terre; plastique, noir / plastique, transparent

L 115, B 60, H 185

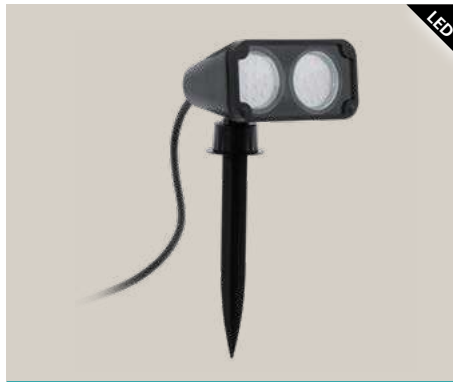
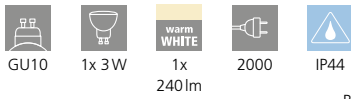

93385 NEMA 1

ground spike; plastic, black / plastic, transparent
 Erdspieß; Kunststoff, schwarz / Kunststoff, transparent
 piquet de terre; plastique, noir / plastique, transparent

L 115, B 115, H 180

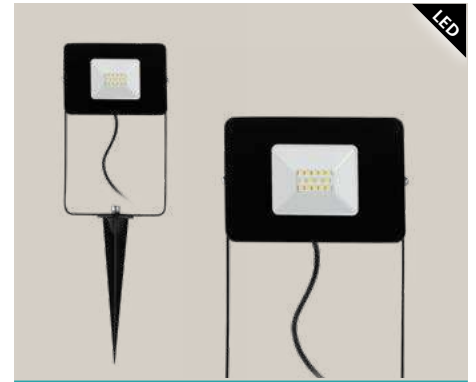
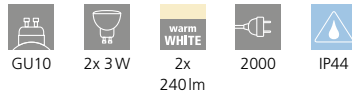

97471 FAEDO 4

ground spike; aluminium, black / glass, clear
 Erdspieß; Alu, schwarz / Glas, klar
 piquet de terre; aluminium, noir / verre, clair

L 115, B 35, H 310

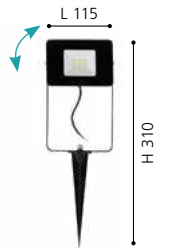

94111 NEMA

ground spike; stainless steel, stainless steel
 Erdspieß; Edelstahl, edelstahl
 piquet de terre; acier inoxydable, acier inoxydable

L 110, B 85, H 240, ET 165



94111

NEMA comes with 3 different coloured bulb shades.

NEMA wird mit 3 verschiedenen farbigen Leuchtmittelabdeckungen ausgeliefert.

NEMA vient avec 3 couvercles d'ampoule en couleurs différentes.

- GL2640
- GL2642
- GL2641
- GL2643



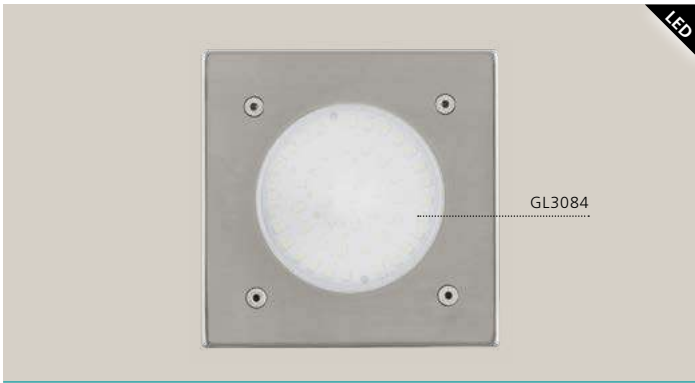

93481 LAMEDO

ground recessed light; stainless steel, stainless steel / satin glass, white
 Bodeneinbauleuchte; Edelstahl, edelstahl / Glas satiniert, weiss
 luminaire encastrable au; acier inoxydable, acier inoxydable / verre satiné, blanc

L 100, B 100, ET 65

LED
 1x 2,5W
 warm WHITE
 1x
 180lm
 IP65/67

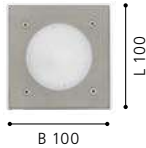

93482 LAMEDO

ground recessed light; stainless steel, stainless steel / satin glass, white
 Bodeneinbauleuchte; Edelstahl, edelstahl / Glas satiniert, weiss
 luminaire encastrable au; acier inoxydable, acier inoxydable / verre satiné, blanc

Ø 100, ET 65

LED
 1x 2,5W
 warm WHITE
 1x
 180lm
 IP65/67



98182 TRONTO

ground recessed light; stainless steel, plastic, stainless steel, black / plastic, transparent
 Bodeneinbauleuchte; Edelstahl, Kunststoff, edelstahl, schwarz / Kunststoff, transparent
 luminaire encastrable au; acier inoxydable, plastique, acier inoxydable, noir / plastique, transparent

H 2, Ø 45, ET 70

LED
 1W
 warm WHITE
 50lm
 IP65/67
 Ø 45





99574 ARACENA

recessed light; aluminium, plastic, white, black / glass, black
 Einbauleuchte; Alu, Kunststoff, weiss, schwarz / Glas, schwarz
 luminaire encastrable; aluminium, plastique, blanc, noir / verre, noir

L 140, B 140, H 5, ET 95

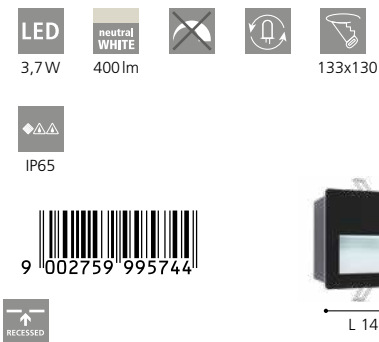

99575 ARACENA

recessed light; aluminium, plastic, white, black / glass, white
 Einbauleuchte; Alu, Kunststoff, weiss, schwarz / Glas, weiss
 luminaire encastrable; aluminium, plastique, blanc, noir / verre, blanc

L 140, B 140, H 5, ET 95

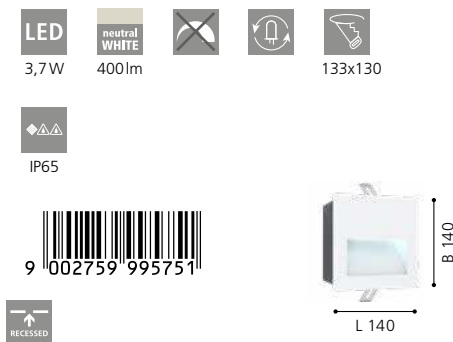

995235 ZIMBA-LED

recessed light; cast aluminium, silver
 Einbauleuchte; Aluguss, silber
 luminaire encastrable; fonte d'aluminium, argent

L 140, B 140, H 5, ET 95

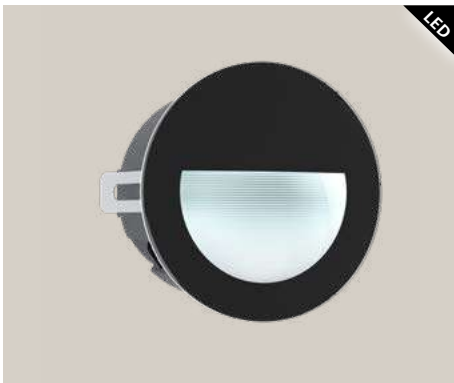
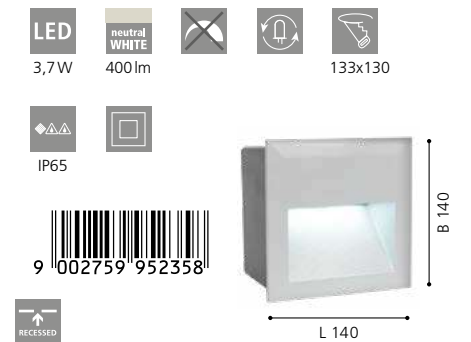

99576 ARACENA

recessed light; aluminium, plastic, white, black / glass, black
 Einbauleuchte; Alu, Kunststoff, weiss, schwarz / Glas, schwarz
 luminaire encastrable; aluminium, plastique, blanc, noir / verre, noir

H 5, Ø 125, ET 95

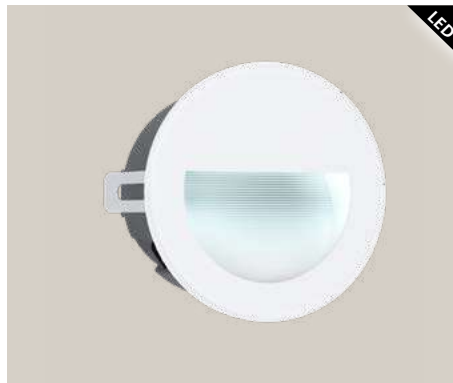

99577 ARACENA

recessed light; aluminium, plastic, white, black / glass, white
 Einbauleuchte; Alu, Kunststoff, weiss, schwarz / Glas, weiss
 luminaire encastrable; aluminium, plastique, blanc, noir / verre, blanc

H 5, Ø 125, ET 95



ARACENA

These spots come with a installation box.

Bei diesen Leuchten ist eine Einbaudose im Lieferumfang enthalten.

Avec ces lumières, il y a une boîte d'installation inclus.



88575 ZIMBA

recessed light; cast aluminium, silver / satin glass, white
 Einbauleuchte; Aluguss, silber / Glas satiniert, weiss
 luminaire encastrable; fonte d'aluminium, argent / verre satiné, blanc

L 227, B 127, H 13, ET 75

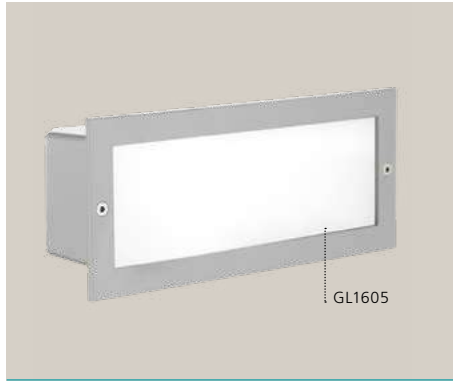
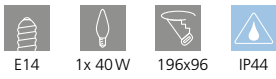

88008 ZIMBA

recessed light; cast aluminium, silver / satin glass, white
 Einbauleuchte; Aluguss, silber / Glas satiniert, weiss
 luminaire encastrable; fonte d'aluminium, argent / verre satiné, blanc

L 243, B 101, H 5, ET 100

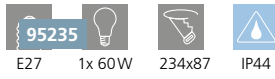

95233 ZIMBA-LED

recessed light; cast aluminium, silver
 Einbauleuchte; Aluguss, silber
 luminaire encastrable; fonte d'aluminium, argent

H 5, Ø 125, ET 95



99574



94093 MARGO

recessed light; cast aluminium, white / satin glass, white

Einbauleuchte; Aluguss, weiss / Glas satiniert, weiss

luminaire encastrable; fonte d'aluminium, blanc / verre satiné, blanc

H 10, Ø 84, ET 125



Ø 84



94092 MARGO

recessed light; cast aluminium, stainless steel / satin glass, white

Einbauleuchte; Aluguss, edelstahl / Glas satiniert, weiss

luminaire encastrable; fonte d'aluminium, acier inoxydable / verre satiné, blanc

H 10, Ø 84, ET 125



Ø 84



96415 PINEDA-IP

recessed light; plastic, satin nickel

Einbauleuchte; Kunststoff, nickel-matt

luminaire encastrable; plastique, nickel mat

Ø 78, ET 35



Ø 78



IP65 / IP44

PINEDA-IP & MARGO

These luminaires are protected with IP65 / IP44 on the frontside and IP20 on the backside.

Diese Leuchten sind mit IP65 / IP44 frontseitig und IP20 rückseitig geschützt.

Disposent d'un degré de protection élevé IP65 / IP44 en face avant et IP20 en face arrière pour l'utilisation.

GARDEN LIVING





98101 MONTEROLO

floor light; plastic, white / plastic, white
Stehleuchte; Kunststoff, weiss / Kunststoff, weiss
lampadaire; plastique, blanc / plastique, blanc

H 300, Ø 300, Base: Ø 120

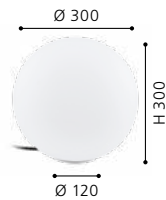
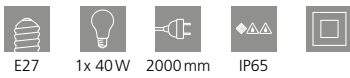

98102 MONTEROLO

floor light; plastic, white / plastic, white
Stehleuchte; Kunststoff, weiss / Kunststoff, weiss
lampadaire; plastique, blanc / plastique, blanc

H 390, Ø 390, Base: Ø 195

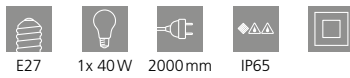

98103 MONTEROLO

floor light; plastic, white / plastic, white
Stehleuchte; Kunststoff, weiss / Kunststoff, weiss
lampadaire; plastique, blanc / plastique, blanc

H 500, Ø 500, Base: Ø 195

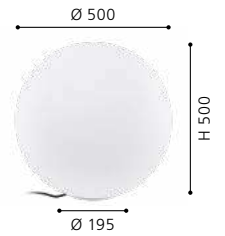

98104 MONTEROLO

floor light; plastic, white / plastic, white
Stehleuchte; Kunststoff, weiss / Kunststoff, weiss
lampadaire; plastique, blanc / plastique, blanc

H 600, Ø 600, Base: Ø 195

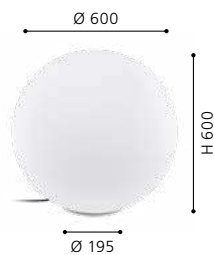



900291





900189



900292



900246



90°, 6 m

SAFETY & COMFORT

900189 EREMITANA

wall light; zinc-plated steel, black
Wandleuchte; Stahl verzinkt, schwarz
applique; acier galvanisé, noir

L 110, H 240, A 110



GU10 2x 2,8W 2x 250lm IP55



9 008606 234264



900292 LESMO

wall light; cast aluminium, black / glass, clear
Wandleuchte; Aluguss, schwarz / Glas, klar
applique; fonte d'aluminium, noir / verre, transparent

L 240, B 105, A 115



4x 2,2W 920lm IP44



9 008606 231560

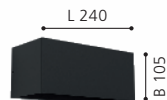

900246 BARACCONI

floor light; aluminium, plastic, black / plastic, satiné
Stehleuchte; Alu, Kunststoff, schwarz / Kunststoff, satiniert
lampadaire; aluminium, plastique, noir / plastique, satiné

L 90, B 200, H 800



18x 0,2W warm WHITE Li-ion 2200 mAh



9 008606 230013

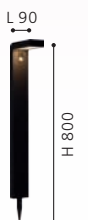



900285



900287



900286

900285 CARRARO

wall light; steel, black / glass, clear
Wandleuchte; Stahl, schwarz / Glas, klar
applique; acier, noir / verre, transparent

L 115, H 380, A 130

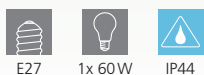

9 008606 231577

900286 CARRARO

wall light; steel, grey, black / glass, clear
Wandleuchte; Stahl, grau, schwarz / Glas, klar
applique; acier, gris, noir / verre, transparent

L 115, H 380, A 130

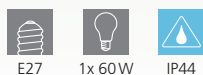

9 008606 231584

900287 CHIAPPERA

wall light; steel, black, white / glass, clear
Wandleuchte; Stahl, schwarz, weiss / Glas, klar
applique; acier, noir, blanc / verre, transparent

L 220, H 225, A 245



9 008606 231645



900288



900288,900289

This luminaire can be mounted upwards or downwards.

Diese Leuchten können aufwärts oder abwärts montiert werden.

Ces luminaires peut être montée vers le haut ou vers le bas.



900289

900288 BUDRONE

wall light; steel, black / glass, clear
Wandleuchte; Stahl, schwarz / Glas, klar
applique; acier, noir / verre, transparent

L 120, H 270, A 165



E27



1x 40W



IP44



9 008606 231607

900289 BUDRONE

wall light; steel, wood, black, brown / glass, clear
Wandleuchte; Stahl, Holz, schwarz, braun / Glas, klar
applique; acier, bois, noir, marron / verre, transparent

L 120, H 270, A 165



E27



1x 40W



IP44



9 008606 231591



900259



900122



900259 LADUNARA

floor light; steel, black
 Stehleuchte; Stahl, schwarz
 lampadaire; acier, noir

900122 FOSSOMBRONE

floor light; zinc-plated steel, black / plastic, white
 Stehleuchte; Stahl verzinkt, schwarz / Kunststoff, weiss
 lampadaire; acier galvanisé, noir / plastique, blanc

900123 FUSIGNANO

table light; zinc-plated steel, black / glass etched, white
 Tischleuchte; Stahl verzinkt, schwarz / Glas geätzt, weiss
 luminaire de table; acier galvanisé, noir / verre gravé, blanc

H 1115, Ø 250, Base: B 700, T 700



H 685, Ø 320, Base: Ø 230

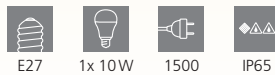

H 410, Ø 265

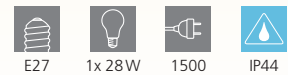



900123



900296

On/off switch on the lampshade.

Ein/Aus-Schalter am Lampenschirm.

Interrupteur marche/arrêt sur l'abat-jour.

900296



900294, 900295, 900296

Bulb not included!

Leuchtmittel sind nicht inkludiert!

L'ampoule sont non inclus !



900296 ALGHERA

floor light; plastic, black / plastic, white
Stehleuchte; Kunststoff, schwarz / Kunststoff, weiss
lampadaire; plastique, noir / plastique, blanc

H 1485, Ø 390



E27 1x 15W 2000 IP44



9 008606 232598

900294 BOTTONA

floor light; plastic, white
Stehleuchte; Kunststoff, weiss
lampadaire; plastique, blanc

L 300, B 300, H 300



E27 1x 15W 2000 IP65



9 008606 232574

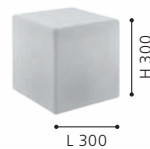

900295 BOTTONA

floor light; plastic, white
Stehleuchte; Kunststoff, weiss
lampadaire; plastique, blanc

L 400, B 400, H 400



E27 1x 15W 2000 IP65



9 008606 232581

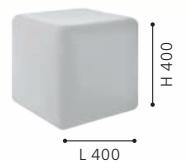



900295



900294





900203

900202

900201

900201 MONTEROLLO SMOKE

ground spike; plastic, black / plastic, black-transparent
 Erdspieß; Kunststoff, schwarz / Kunststoff, schwarz-transparent
 piquet de terre; plastique, noir / plastique, noir transparent

900202 MONTEROLLO SMOKE

ground spike; plastic, black / plastic, black-transparent
 Erdspieß; Kunststoff, schwarz / Kunststoff, schwarz-transparent
 piquet de terre; plastique, noir / plastique, noir transparent

900203 MONTEROLLO SMOKE

ground spike; plastic, black / plastic, black-transparent
 Erdspieß; Kunststoff, schwarz / Kunststoff, schwarz-transparent
 piquet de terre; plastique, noir / plastique, noir transparent

H 240, Ø 200



H 340, Ø 300

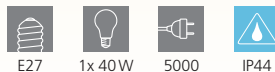

H 440, Ø 400

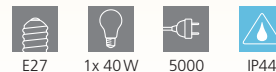

9 008606 229895



9 008606 229901



9 008606 229918





EGLO
my light | my style

EGLO Leuchten GmbH
Heiligkreuz 22
A-6136 Pill
Austria
Tel. +43 (0) 5242 6996
Fax +43 (0) 5242 6996-972
info@eglo.com
www.eglo.com



my light | my style