



**EGLO**

my light | my style



**EGLO**  
my light | my style



**INTERIOR LIGHTING**

WOHNRAUMLEUCHTEN  
LUMINAIRES INTERIEURS

ABREOSA

HIGHLIGHTS



## LAGUNITAS

**Brass** - Brass so popular back in the 50s and 60s, is currently enjoying a new wave of popularity. Skilfully paired with contrasting materials, the gleaming metallic hues of brass bring a touch of luxury to living spaces without appearing old-fashioned. We have incorporated the high-quality material into our new luminaire models and combined it with diverse other materials to create captivating modern designs that can be integrated into a variety of interiors, from urban to classical to minimalist.

**Messing** - Der bereits in den 50er und 60er Jahren so populäre Messingtrend erfreut sich aktuell an neuer Beliebtheit. Gekonnt kombiniert und kontrastreich in Szene gesetzt, bringt Messing mit seinem strahlenden Metallton einen Hauch von Luxus in die Wohnräume, ohne altmodisch zu wirken. Das hochwertige Material haben wir in unsere neuen Leuchten-Modelle einfließen lassen und in Kombination mit verschiedenen Materialien charmante und moderne Designs geschaffen, die sich in unterschiedliche Einrichtungen von urban über klassisch bis hin zu minimalistisch integrieren lassen.

**Le laitton** - La tendance du laitton, déjà si populaire dans les années 50 et 60, est actuellement à nouveau au goût du jour. Habilement combiné et mis en scène avec de riches contrastes, le laitton avec sa teinte métallique brillante apporte une touche de luxe aux espaces de vie sans paraître démodé. Nous avons incorporé ce matériau de haute qualité dans nos nouveaux modèles de luminaires et, en combinaison avec divers matériaux, avons créé des designs charmants et modernes qui peuvent être intégrés à des aménagements différents, qu'ils soient notamment urbains, classiques ou encore minimalistes.

**Warm earth tones** - The very popular back-to-nature trend has also brought about a significant shift in the field of design. More and more people have been embracing a return to nature in recent years and the associated use of natural materials has also left its mark on the world of colour, heralding the rise of brown as the new black. The colour brown in all its many facets can be beautifully paired with almost any other colour and, thanks to its diverse earthy tones, not only lends our living spaces a touch of naturalness, but also conveys a sense of warmth and comfort. Combining this year's popular colour trend with wood and brass elements helps accentuate its distinctive appeal.

**Warme Erdtöne** - Der starke Trend hin zu mehr Natürlichkeit hat auch im Design einen bedeutsamen Wandel bewirkt. Die in den letzten Jahren deutlich an Bedeutung gewonnene Verbundenheit zur Natur und die damit einhergehende Verwendung von natürlichen Materialien hat auch die Farbwelt geprägt und lässt Braun als das neue Schwarz triumphieren. Braun in all seinen Facetten lässt sich hervorragend kombinieren und verleiht unseren Wohnräumen durch seine vielfältigen Erdtöne nicht nur einen Hauch von Natürlichkeit, sondern vermittelt Gemütlichkeit und Behaglichkeit gleichermaßen. Die Kombination mit Holz oder Messing verleiht der neuen Trendfarbe ihre besonderen Akzente.

**Des tons chauds de terre** - La forte tendance vers un caractère plus naturel a également entraîné un changement significatif dans notre conception. Le lien avec la nature, qui a grandement gagné en importance ces dernières années, et l'utilisation associée de matériaux naturels ont également façonné l'univers des couleurs : c'est ainsi que le brun a détrôné le noir. Le brun sous toutes ses facettes peut être parfaitement combiné et, avec ses divers tons de terre, non seulement donner à nos salons une touche naturelle, mais aussi procurer confort et bien-être dans le même temps. La combinaison de cette nouvelle couleur tendance avec le bois ou le laiton lui confère ses accents si particuliers.



LOSALOMAS

HIGHLIGHTS

# Look out for this Logo!

Achten Sie auf das Logo!

Soyez attentif au logo !

## What is a forest?

A peaceful oasis, the green lungs of the world, and an adventure playground for children of all ages!

The Forest Stewardship Council® (FSC®) is a global, not-for-profit organisation dedicated to the promotion of responsible forest management worldwide. The FSC® defines standards for responsible forest management in accordance with established principles that are developed and supported by stakeholders from the environmental, social and economic spheres. For more information, please see [www.fsc.org](http://www.fsc.org).

## Was ist Wald für uns?

Eine Oase der Ruhe, die Lunge der Welt oder ein Abenteuerspielplatz für große und kleine Kinder!

Das Forest Stewardship Council® (FSC®) ist eine globale, gemeinnützige Organisation, mit dem Zweck verantwortungsvolle Waldbewirtschaftung weltweit zu fördern. FSC® definiert Standards für eine verantwortungsvolle Waldbewirtschaftung nach festgelegten Prinzipien, die von Interessenvertretern aus den Bereichen Umwelt, Soziales und Wirtschaft entwickelt und getragen werden. Für weitere Informationen besuchen Sie [www.fsc.org](http://www.fsc.org).

## Que représente la forêt pour nous ?

Une oasis de calme, les poumons du monde ou un terrain de jeu d'aventure pour les enfants de tous âges !

Le Forest Stewardship Council® (FSC®) est une organisation internationale à but non lucratif dont le but est de promouvoir une gestion forestière responsable dans le monde entier. Le FSC® définit des normes de gestion forestière responsable selon des principes établis qui sont développés et soutenus par les parties prenantes des secteurs environnemental, social et économique. Pour plus d'informations, veuillez consulter [www.fsc.org](http://www.fsc.org).

Look out for FSC® -certified products!  
Achten Sie auf FSC® -zertifizierte Produkte!  
Soyez attentif aux produits certifiés FSC® !



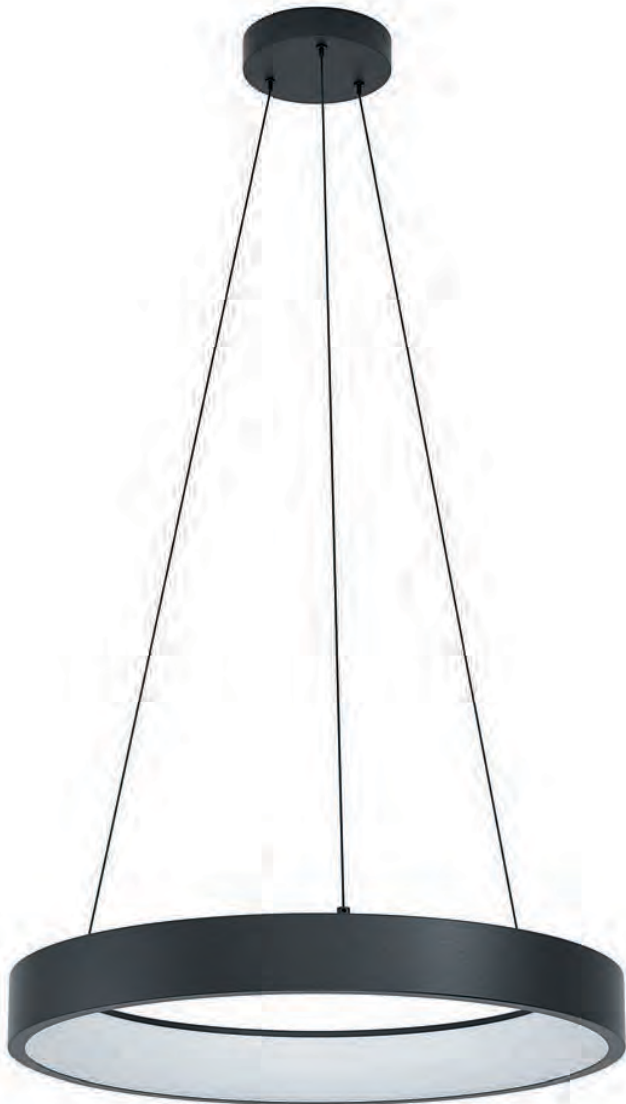

900068

LED



900067

LED



900069

LED

### 900068 MARGHERA-Z

pendant light; steel, black / plastic, white  
Hängeleuchte; Stahl, schwarz / Kunststoff, weiss  
luminaire en suspension; acier, noir / plastique, blanc

H 1100, Ø 600

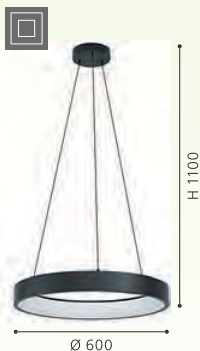

9 008606 222032

### 900067 MARGHERA-Z

ceiling light; steel, black / plastic, white  
Deckenleuchte; Stahl, schwarz / Kunststoff, weiss  
plafonnier; acier, noir / plastique, blanc

H 110, Ø 600

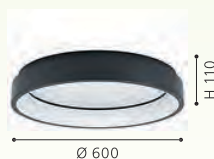

9 008606 222025

### 900069 MARGHERA-Z

wall light; steel, black / plastic, white  
Wandleuchte; Stahl, schwarz / Kunststoff, weiss  
applique; acier, noir / plastique, blanc

L 270, H 305, A 200



9 008606 222049

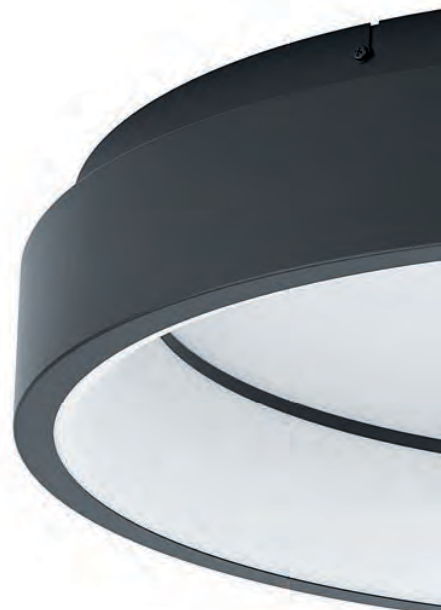

**900071**  
LED



**900072**  
LED

**900071 MARGHERA-Z**

table light; steel, black / plastic, white  
Tischleuchte; Stahl, schwarz / Kunststoff, weiss  
luminaire de table; acier, noir / plastique, blanc

L 270, H 265, Base: Ø 145



**900072 MARGHERA-Z**

floor light; steel, black / plastic, white  
Stehleuchte; Stahl, schwarz / Kunststoff, weiss  
lampadaire; acier, noir / plastique, blanc

L 270, B 305, H 1690, Base: Ø 305

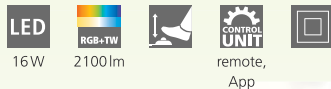





98295



98296



98295, 98296

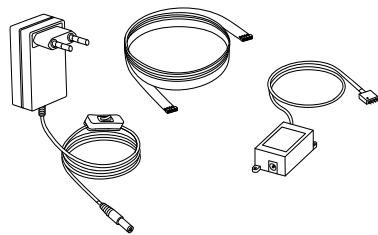

### 98295 LED-STRIPE-A

bar / strip light; plastic, white  
Leuchtband/-stab; Kunststoff, weiss  
bande lumineuse / bâton l; plastique, blanc

L 2000, B 10, H 3



9 002759 982959

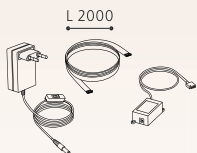

### 98296 LED-STRIPE-A

bar / strip light; plastic, white  
Leuchtband/-stab; Kunststoff, weiss  
bande lumineuse / bâton l; plastique, blanc

L 5000, B 10, H 3



9 002759 982966

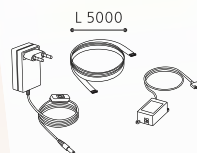

98295, 98296

These articles include a remote control.

Bei diesen Artikeln ist eine Fernbedienung inkludiert.

Ces articles comprennent une télécommande.



**99302**



**99091**



**99301**



99089 | 99298 | 99091 |  
99301

### 99302 POSADERRA

ceiling light; steel, white / fabric, plastic, taupe, white  
Deckenleuchte; Stahl, weiss / Textil, Kunststoff, taupe, weiss  
plafonnier; acier, blanc / tissu, plastique, taupe, blanc

L 140, B 140, H 150



E27

1x 28W

### 99091 PASTERI SQUARE

ceiling light; steel, white / fabric, plastic, taupe, white  
Deckenleuchte; Stahl, weiss / Textil, Kunststoff, taupe, weiss  
plafonnier; acier, blanc / tissu, plastique, taupe, blanc

L 575, B 575, H 165



E27

5x 25W

### 99301 POSADERRA

ceiling light; steel, white / fabric, plastic, taupe, white  
Deckenleuchte; Stahl, weiss / Textil, Kunststoff, taupe, weiss  
plafonnier; acier, blanc / tissu, plastique, taupe, blanc

L 750, B 280, H 150



E27

3x 28W



9 002759 993023

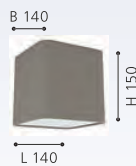

9 002759 990916

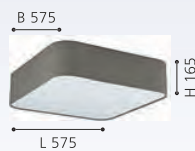

9 002759 993016

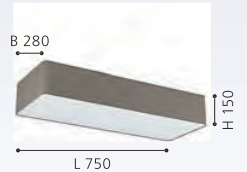



94919



94919



94925



96478



### 94919 PASTERI

ceiling light; steel, satin nickel / fabric, glass, taupe  
Deckenleuchte; Stahl, nickel-matt / Textil, Glas, taupe  
plafonnier; acier, nickel mat / tissu, verre, taupe

H 195, Ø 475



9 002759 949198



### 94925 PASTERI

wall light; steel, satin nickel / fabric, taupe  
Wandleuchte; Stahl, nickel-matt / Textil, taupe  
applique; acier, nickel mat / tissu, taupe

L 145, H 305, A 195



9 002759 949259



### 96478 PASTERI

wall light; steel, satin nickel / fabric, taupe  
Wandleuchte; Stahl, nickel-matt / Textil, taupe  
applique; acier, nickel mat / tissu, taupe

L 150, H 380, A 195



9 002759 964788





**94926**



**96479**

**LED**

### 94926 PASTERI

wall light; steel, satin nickel / fabric, grey  
Wandleuchte; Stahl, nickel-matt / Textil, grau  
applique; acier, nickel mat / tissu, gris

L 145, H 305, A 195



E27 1x 60W



9 002759 949266



A 195

### 96479 PASTERI

wall light; steel, satin nickel / fabric, grey  
Wandleuchte; Stahl, nickel-matt / Textil, grau  
applique; acier, nickel mat / tissu, gris

L 150, H 380, A 195



E27 1x 40W 1x 3,5W 1x 380lm



9 002759 964795



A 195



31583

### 31583 PASTERI

pendant light; steel, satin nickel / fabric, anthracite-brown  
Hängeleuchte; Stahl, nickel-matt / Textil, anthrazit-braun  
luminaire en suspension; acier, nickel mat / tissu, anthracite  
marron

L 750, B 220, H 1100



E27



2x 60W



L 750

H 1100



31579



31575

DESIGN  
HIGHLIGHT  
DETAIL



### 31579 PASTERI

pendant light; steel, satin nickel / fabric, white  
Hängeleuchte; Stahl, nickel-matt / Textil, weiss  
luminaire en suspension; acier, nickel mat / tissu, blanc

L 750, B 220, H 1100



E27 2x 60W



9 002759 315795



L 750

H 1100

### 31575 PASTERI

pendant light; steel, satin nickel / fabric, white  
Hängeleuchte; Stahl, nickel-matt / Textil, weiss  
luminaire en suspension; acier, nickel mat / tissu, blanc

H 1100, Ø 530



E27 1x 60W



9 002759 315757



Ø 530

H 1100



94924



95118



96477

LED

### 95118

These luminaires can be switched on and off by touching the specially designed "Touch Me" part of the fixture.

Diese Leuchten können ein- und ausgeschaltet werden, indem man sie an den dafür vorgesehenen "Touch Me" Bereichen berührt.

Ces luminaires peuvent être éteints et allumés simplement en touchant la partie spécialement conçue pour "Touch Me" du luminaire.



### 96477 PASTERI

wall light; steel, satin nickel / fabric, white  
Wandleuchte; Stahl, nickel-matt / Textil, weiss  
applique; acier, nickel mat / tissu, blanc

L 150, H 380, A 195



9 002759 964771



### 94924 PASTERI

wall light; steel, satin nickel / fabric, white  
Wandleuchte; Stahl, nickel-matt / Textil, weiss  
applique; acier, nickel mat / tissu, blanc

L 145, H 305, A 195



9 002759 949242



### 95118 PASTERI

table light; steel, satin nickel / fabric, white  
Tischleuchte; Stahl, nickel-matt / Textil, weiss  
luminaire de table; acier, nickel mat / tissu, blanc

H 255, Ø 120

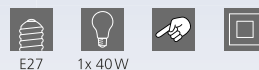

9 002759 951184





95044



95045

### 95044 PASTERI

pendant light; steel, satin nickel / fabric, white, copper  
Hängeleuchte; Stahl, nickel-matt / Textil, weiss, kupfer  
luminaire en suspension; acier, nickel mat / tissu, blanc, cuivre

H 1100, Ø 380



E27



1x 60W



9 002759 950446



### 95045 PASTERI

pendant light; steel, satin nickel / fabric, white, copper  
Hängeleuchte; Stahl, nickel-matt / Textil, weiss, kupfer  
luminaire en suspension; acier, nickel mat / tissu, blanc, cuivre

H 1100, Ø 530



E27



1x 60W



9 002759 950453







97643



97644

### 97643 VISERBELLA

pendant light; steel, champagne / fabric, gold  
 Hängeleuchte; Stahl, champagner / Textil, gold  
 luminaire en suspension; acier, champagne / tissu, or

H 1100, Ø 380



E27 1x 60W



9 002759 976439



### 97644 VISERBELLA

pendant light; steel, champagne / fabric, gold  
 Hängeleuchte; Stahl, champagner / Textil, gold  
 luminaire en suspension; acier, champagne / tissu, or

H 1100, Ø 530



E27 3x 60W



9 002759 976446



### 97641 VISERBELLA

ceiling light; steel, champagne / fabric, gold  
 Deckenleuchte; Stahl, champagner / Textil, gold  
 plafonnier; acier, champagne / tissu, or

H 110, Ø 380



E27 1x 60W



9 002759 976415





DESIGN  
HIGHLIGHT  
DETAIL



97645



97647

### 97645 VISERBELLA

wall light; steel, champagne / fabric, gold  
Wandleuchte; Stahl, champagner / Textil, gold  
applique; acier, champagne / tissu, or

L 145, H 305, A 195



E27 1x 60W



9 002759 976453



### 97647 VISERBELLA

floor light; steel, champagne / fabric, gold  
Stehleuchte; Stahl, champagner / Textil, gold  
lampadaire; acier, champagne / tissu, or

H 1585, Ø 280, Base: Ø 230



E27 1x 60W



9 002759 976477



### 97646 VISERBELLA

table light; steel, champagne / fabric, gold  
Tischleuchte; Stahl, champagner / Textil, gold  
luminaire de table; acier, champagne / tissu, or

H 400, Ø 180, Base: Ø 150



E27 1x 60W



9 002759 976460

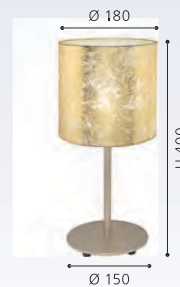



DESIGN  
HIGHLIGHT  
DETAIL



99272

99273

### 99273 ESTEPERRA

pendant light; steel, black / fabric, black, gold  
Hängeleuchte; Stahl, schwarz / Textil, schwarz, gold  
luminaire en suspension; acier, noir / tissu, noir, or

H 1100, Ø 380



E27 1x 40W



9 002759 992736



### 99272 ESTEPERRA

ceiling light; steel, black / fabric, black, gold  
Deckenleuchte; Stahl, schwarz / Textil, schwarz, gold  
plafonnier; acier, noir / tissu, noir, or

H 240, Ø 475



E27 1x 40W



9 002759 992729



### 99274 ESTEPERRA

pendant light; steel, black / fabric, black, gold  
Hängeleuchte; Stahl, schwarz / Textil, schwarz, gold  
luminaire en suspension; acier, noir / tissu, noir, or

H 1100, Ø 530



E27 3x 40W



9 002759 992743





99275

DESIGN  
HIGHLIGHT  
DETAIL



### 99279 ESTEPERRA

floor light; steel, black / fabric, black, gold  
Stehleuchte; Stahl, schwarz / Textil, schwarz, gold  
lampadaire; acier, noir / tissu, noir, or

H 1405, Ø 380, Base: Ø 645



E27



1x 40W



9 002759 992798

### 99275 ESTEPERRA

pendant light; steel, black / fabric, black, gold  
Hängeleuchte; Stahl, schwarz / Textil, schwarz, gold  
luminaire en suspension; acier, noir / tissu, noir, or

L 940, B 160, H 1100



E27



4x 28W



9 002759 992750



99613

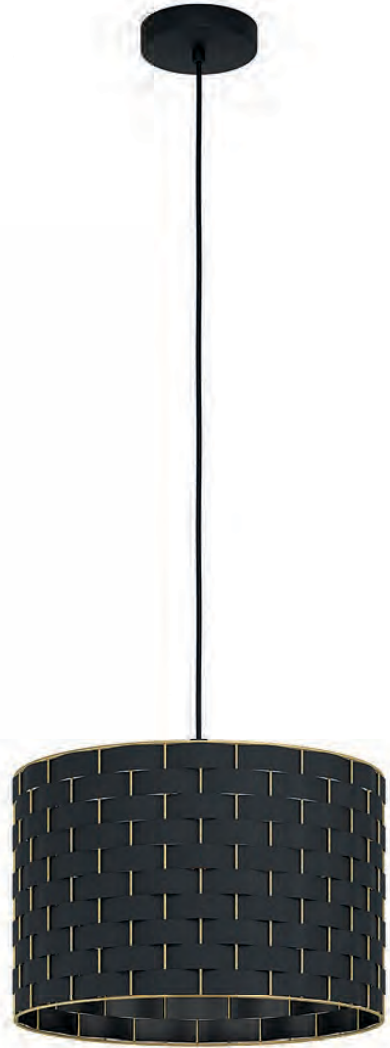

99524

### 99613 MARASALES

pendant light; steel, black / fabric, black, brass  
 Hängeleuchte; Stahl, schwarz / Textil, schwarz, messing  
 luminaire en suspension; acier, noir / tissu, noir, laiton

L 780, B 220, H 1100



E27 2x 40W



9 002759 996130

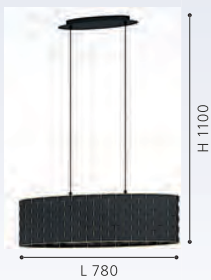

L 780

### 99524 MARASALES

pendant light; steel, black / fabric, black, brass  
 Hängeleuchte; Stahl, schwarz / Textil, schwarz, messing  
 luminaire en suspension; acier, noir / tissu, noir, laiton

H 1100, Ø 380



E27 1x 40W



9 002759 995249



Ø 380

### 99525 MARASALES

pendant light; steel, black / fabric, black, brass  
 Hängeleuchte; Stahl, schwarz / Textil, schwarz, messing  
 luminaire en suspension; acier, noir / tissu, noir, laiton

H 1100, Ø 550



E27 1x 40W



9 002759 995256



Ø 550



99523

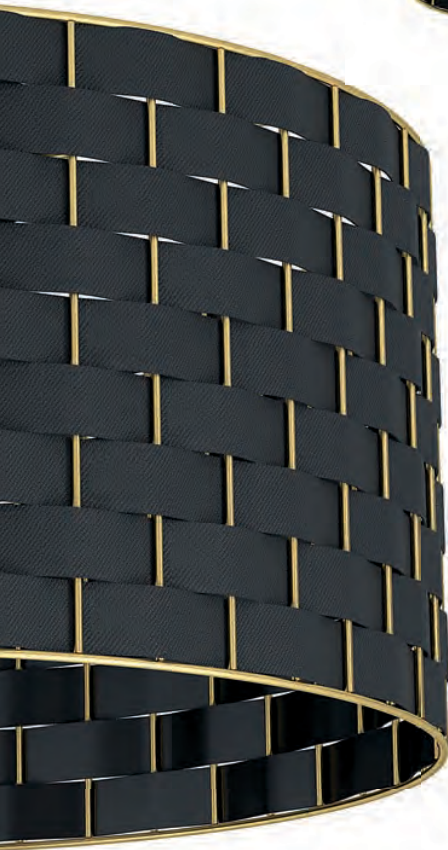

DESIGN  
HIGHLIGHT  
DETAIL



99526

### 99523 MARSALES

ceiling light; steel, black / fabric, black, brass  
Deckenleuchte; Stahl, schwarz / Textil, schwarz, messing  
plafonnier; acier, noir / tissu, noir, laiton

H 250, Ø 480



9 002759 995232

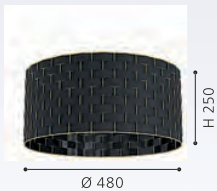

### 99526 MARSALES

table light; steel, black / fabric, black, brass  
Tischleuchte; Stahl, schwarz / Textil, schwarz, messing  
luminaire de table; acier, noir / tissu, noir, laiton

H 570, Ø 280

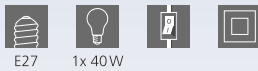

9 002759 995263



### 99527 MARSALES

floor light; steel, black / fabric, black, brass  
Stehleuchte; Stahl, schwarz / Textil, schwarz, messing  
lampadaire; acier, noir / tissu, noir, laiton

H 1490, Ø 450, Base: Ø 745

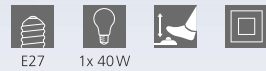

9 002759 995270





MASERLO 1



99042



99043

### 99044 MASERLO 1

pendant light; steel, black / fabric, black  
 Hängeleuchte; Stahl, schwarz / Textil, schwarz  
 luminaire en suspension; acier, noir / tissu, noir

L 780, B 220, H 1100



E27 2x 40W



9 002759 990442



L 780

### 99042 MASERLO 1

pendant light; steel, black / fabric, black  
 Hängeleuchte; Stahl, schwarz / Textil, schwarz  
 luminaire en suspension; acier, noir / tissu, noir

H 1100, Ø 380



E27 1x 40W



9 002759 990428



Ø 380

### 99043 MASERLO 1

pendant light; steel, black / fabric, black  
 Hängeleuchte; Stahl, schwarz / Textil, schwarz  
 luminaire en suspension; acier, noir / tissu, noir

H 1100, Ø 530



E27 1x 60W



9 002759 990435



Ø 530



DESIGN  
HIGHLIGHT  
DETAIL



99041



MASERLO 1



99045

### 99041 MASERLO 1

ceiling light; steel, black / fabric, black  
Deckenleuchte; Stahl, schwarz / Textil, schwarz  
plafonnier; acier, noir / tissu, noir

H 240, Ø 400



E27



1x 40W



9 002759 990411



### 99045 MASERLO 1

table light; steel, black / fabric, black  
Tischleuchte; Stahl, schwarz / Textil, schwarz  
luminaire de table; acier, noir / tissu, noir

H 415, Ø 230, Base: Ø 145



E27



1x 40W



9 002759 990459



### 99046 MASERLO 1

floor light; steel, black / fabric, black  
Stehleuchte; Stahl, schwarz / Textil, schwarz  
lampadaire; acier, noir / tissu, noir

H 1515, Ø 380, Base: Ø 250



E27



1x 40W



9 002759 990466







99539

LED



31627

### 99539 MASERLO 2

ceiling light; plastic, steel, white / fabric, black, gold  
Deckenleuchte; Kunststoff, Stahl, weiss / Textil, schwarz, gold  
plafonnier; plastique, acier, blanc / tissu, noir, or

H 90, Ø 380



24W 2100lm

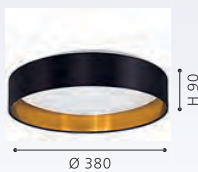

### 31627 MASERLO

table light; steel, satin nickel / fabric, black, gold  
Tischleuchte; Stahl, nickel-matt / Textil, schwarz, gold  
luminaire de table; acier, nickel mat / tissu, noir, or

H 420, Ø 230



E27 1x 60W



### 95169 MASERLO

floor light; steel, satin nickel / fabric, black, gold  
Stehleuchte; Stahl, nickel-matt / Textil, schwarz, gold  
lampadaire; acier, nickel mat / tissu, noir, or

H 1510, Ø 380, Base: Ø 250

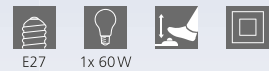

E27 1x 60W





97682

97683



97685

### 97682 CONCESSA 1

pendant light; steel, dark brown / fabric, cappuccino, gold  
Hängeleuchte; Stahl, dunkelbraun / Textil, cappuccino, gold  
luminaire en suspension; acier, marron foncé / tissu, cappuccino, or

H 1500, Ø 380



9 002759 976828



### 97683 CONCESSA 1

pendant light; steel, dark brown / fabric, cappuccino, gold  
Hängeleuchte; Stahl, dunkelbraun / Textil, cappuccino, gold  
luminaire en suspension; acier, marron foncé / tissu, cappuccino, or

H 1500, Ø 530



9 002759 976835



### 97685 CONCESSA 1

pendant light; steel, dark brown / fabric, cappuccino, gold  
Hängeleuchte; Stahl, dunkelbraun / Textil, cappuccino, gold  
luminaire en suspension; acier, marron foncé / tissu, cappuccino, or

L 940, B 160, H 1500



9 002759 976859





99486

99487

### 99487 ALMEIDA 2

pendant light; steel, brushed brass / fabric, cappuccino, brass  
Hängeleuchte; Stahl, messing-gebürstet / Textil, cappuccino, messing

luminaire en suspension; acier, laiton brossé / tissu, cappuccino, laiton

L 1200, B 155, H 1100



E14 5x 40W



9 002759 99487



L 1200

H 1100

### 99486 ALMEIDA 2

ceiling light; steel, brushed brass / fabric, cappuccino, brass  
Deckenleuchte; Stahl, messing-gebürstet / Textil, cappuccino, messing

plafonnier; acier, laiton brossé / tissu, cappuccino, laiton

L 810, B 155, H 280



E14 3x 40W



9 002759 99486



L 810

H 280

### 99612 ALMEIDA 2

floor light; steel, brushed brass / fabric, cappuccino, brass  
Stehleuchte; Stahl, messing-gebürstet / Textil, cappuccino, messing

lampadaire; acier, laiton brossé / tissu, cappuccino, laiton

H 1670, Ø 320, Base: Ø 300



E27 3x 40W



9 002759 996123

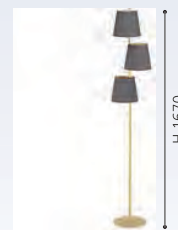

Ø 300

H 1670



99612

### 99611 ALMEIDA 2

table light; steel, brushed brass / fabric, cappuccino, brass  
Tischleuchte; Stahl, messing-gebürstet / Textil, cappuccino, messing  
luminaire de table; acier, laiton brossé / tissu, cappuccino, laiton

H 605, Ø 260, Base: Ø 200



E27



2x 40W



9 002759 996116



99611



98587



98588



### 98587 ALMEIDA 1

pendant light; steel, black / fabric, grey, white  
 Hängeleuchte; Stahl, schwarz / Textil, grau, weiss  
 luminaire en suspension; acier, noir / tissu, gris, blanc

L 860, B 255, H 1100



E14 3x 25W



9 002759 985875



L 860

H 1100

### 98588 ALMEIDA 1

pendant light; steel, black / fabric, black, grey, white  
 Hängeleuchte; Stahl, schwarz / Textil, schwarz, grau, weiss  
 luminaire en suspension; acier, noir / tissu, noir, gris, blanc

L 1200, B 255, H 1100



E14 5x 25W



9 002759 985882



L 1200

H 1100





**95193**



**95192**



**95194**

**95193 ALMEIDA**

wall light; steel, black / fabric, white, anthracite  
Wandleuchte; Stahl, schwarz / Textil, weiss, anthrazit  
applique; acier, noir / tissu, blanc, anthracite

L 420, H 455, A 190



E14 2x 40W

**95192 ALMEIDA**

ceiling light; steel, black / fabric, anthracite, white, brown  
Deckenleuchte; Stahl, schwarz / Textil, anthrazit, weiss, braun  
plafonnier; acier, noir / tissu, anthracite, blanc, marron

H 350, Ø 590



E14 3x 40W

**95194 ALMEIDA**

table light; steel, black / fabric, white, anthracite  
Tischleuchte; Stahl, schwarz / Textil, weiss, anthrazit  
luminaire de table; acier, noir / tissu, blanc, anthracite

L 380, B 185, H 475



E14 2x 40W



9 002759 951931

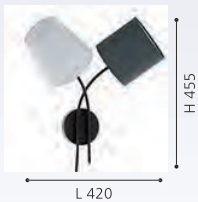

L 420

H 455



9 002759 951924

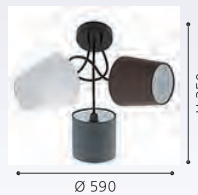

Ø 590

H 350



9 002759 951948



L 380

H 475



DESIGN  
HIGHLIGHT  
DETAIL



92755

### 92755 TOMBOLO

pendant light; steel, satin nickel / fabric with hoop-and-loop tape, creme, taupe, brown

Hängeleuchte; Stahl, nickel-matt / Textil mit Klettverschluss, creme, taupe, braun

luminaire en suspension; acier, nickel mat / tissu avec fermeture velcro, crème, taupe, marron

H 1100, Ø 545



E27



3x 60W



### 94995 MARONDA

floor light; steel, black / fabric, anthracite, white, brown  
Stehleuchte; Stahl, schwarz / Textil, anthrazit, weiss, braun  
lampadaire; acier, noir / tissu, anthracite, blanc, marron

L 275, B 35, H 1520



E14



3x 40W



9 002759 927554

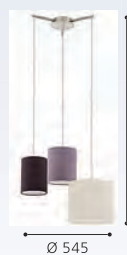

H 1100

Ø 545



9 002759 949952

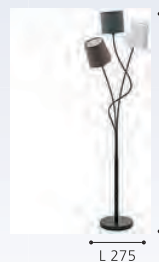

L 275

H 1520



95599

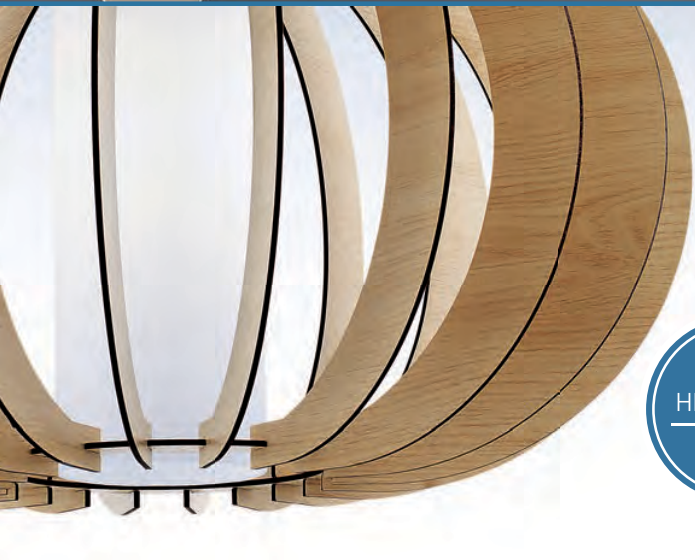

DESIGN  
HIGHLIGHT  
DETAIL

### 95599 STELLATO 1

pendant light; steel, satin nickel / wood, glass, maple, white  
Hängeleuchte; Stahl, nickel-matt / Holz, Glas, ahorn, weiss  
luminaire en suspension; acier, nickel mat / bois, verre, érable, blanc

H 1500, Ø 500



E27



1x 60W



9 002759 955991







99795



99856



99855



### 99795 LIBERTAD

pendant light; steel, wood, black, brown  
Hängeleuchte; Stahl, Holz, schwarz, braun  
luminaire en suspension; acier, bois, noir, marron

L 180, B 180, H 1100



E27 1x 40W



9 002759 997953



L 180

### 99855 LIBERTAD

pendant light; steel, wood, black, brown  
Hängeleuchte; Stahl, Holz, schwarz, braun  
luminaire en suspension; acier, bois, noir, marron

L 880, B 180, H 1100



E27 3x 40W



9 002759 998554



L 880

### 99856 LIBERTAD

ceiling light; steel, wood, black, brown  
Deckenleuchte; Stahl, Holz, schwarz, braun  
plafonnier; acier, bois, noir, marron

L 860, B 180, H 240



E27 3x 40W



9 002759 998561



L 860



99796

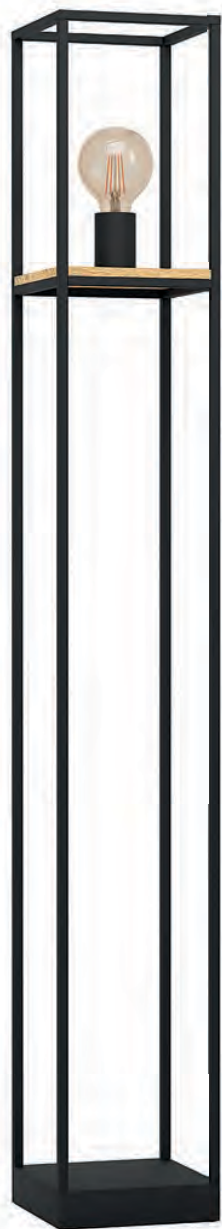

99798



99797



### 99796 LIBERTAD

wall light; steel, wood, black, brown  
Wandleuchte; Stahl, Holz, schwarz, braun  
applique; acier, bois, noir, marron

L 140, H 240, A 165



E27 1x 40W



9 002759 997960



### 99798 LIBERTAD

floor light; steel, wood, black, brown  
Stehleuchte; Stahl, Holz, schwarz, braun  
laminaire; acier, bois, noir, marron

L 180, B 180, H 1285



E27 1x 40W



9 002759 997984

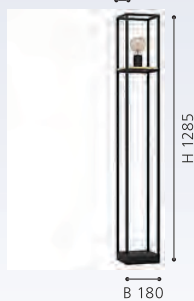

### 99797 LIBERTAD

table light; steel, wood, black, brown  
Tischleuchte; Stahl, Holz, schwarz, braun  
luminaire de table; acier, bois, noir, marron

L 140, B 140, H 350



E27 1x 40W



9 002759 997977





### 99293 CAMACHO

pendant light; steel, wood, black, brown / plastic, white  
 Hängeleuchte; Stahl, Holz, schwarz, braun / Kunststoff, weiss  
 luminaire en suspension; acier, bois, noir, marron / plastique, blanc

L 1100, B 60, H 1100



25,5W 3100lm



9 002759 992934



### 99292 CAMACHO

ceiling light; steel, wood, black, brown / plastic, white  
 Deckenleuchte; Stahl, Holz, schwarz, braun / Kunststoff, weiss  
 plafonnier; acier, bois, noir, marron / plastique, blanc

L 940, B 80, H 115



2x 10W 2x 1300lm



9 002759 992927

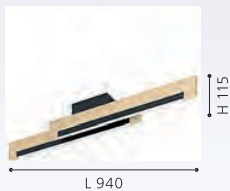

### 99294 CAMACHO

wall light; steel, wood, black, brown / plastic, white  
 Wandleuchte; Stahl, Holz, schwarz, braun / Kunststoff, weiss  
 applique; acier, bois, noir, marron / plastique, blanc

L 440, H 105, A 75



1x 8,5W 1x 1050lm



9 002759 992941





99296



99295

LED

### 99295, 99296

These luminaires can be switched on and off by touching the specially designed "Touch Me" part of the fixture.

Diese Leuchten können ein- und ausgeschaltet werden, indem man sie an den dafür vorgesehenen "Touch Me" Bereichen berührt.

Ces luminaires peuvent être éteints et allumés simplement en touchant la partie spécialement conçue pour "Touch Me" du luminaire.

### 99296 CAMACHO

floor light; steel, wood, black, brown / plastic, white  
Stehleuchte; Stahl, Holz, schwarz, braun / Kunststoff, weiss  
lampadaire; acier, bois, noir, marron / plastique, blanc

H 1260, Base: B 250, T 200



22W



2400lm



B 250



9 002759 992965

### 99295 CAMACHO

table light; steel, wood, black, brown / plastic, white  
Tischleuchte; Stahl, Holz, schwarz, braun / Kunststoff, weiss  
luminaire de table; acier, bois, noir, marron / plastique, blanc

H 405, Base: B 150, T 130



1x 6,5W



1x 800lm



B 150



9 002759 992958



99624

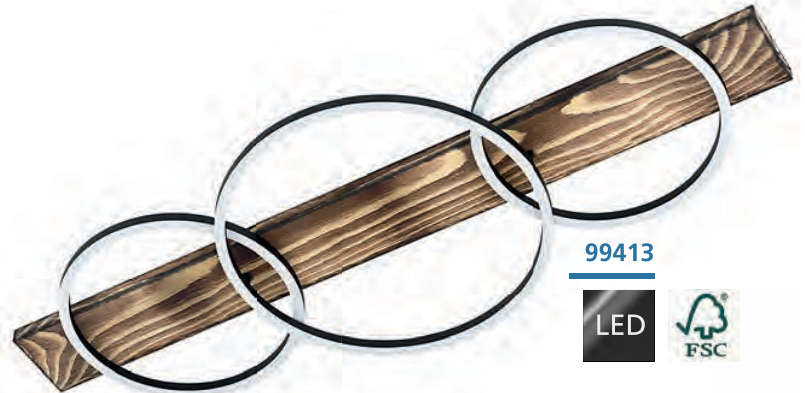

99413



### 99624 BOYAL

pendant light; steel, wood, black, brown rustic / ceramics, white  
Hängeleuchte; Stahl, Holz, schwarz, braun rustikal / Keramik, weiss

luminaire en suspension; acier, bois, noir, marron rustique / céramique, blanc

L 1010, B 400, H 1100

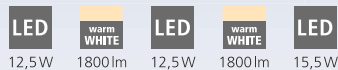

### 99413 BOYAL

ceiling light; steel, wood, black, brown rustic / plastic, white  
Deckenleuchte; Stahl, Holz, schwarz, braun rustikal / Kunststoff, weiss

plafonnier; acier, bois, noir, marron rustique / plastique, blanc

L 1010, B 400, H 95

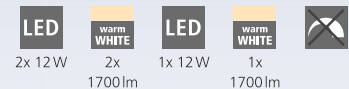



99353

LED



99457

LED



99408

LED



### 99353 BOYAL

wall light; steel, wood, black, brown rustic / plastic, white  
Wandleuchte; Stahl, Holz, schwarz, braun rustikal / Kunststoff, weiss  
applique; acier, bois, noir, marron rustique / plastique, blanc

L 300, H 560, A 75



1x 12W  
1x  
1700lm



L 300

H 560

### 99457 BOYAL

table light; steel, wood, black, brown rustic / plastic, white  
Tischleuchte; Stahl, Holz, schwarz, braun rustikal / Kunststoff, weiss  
luminaire de table; acier, bois, noir, marron rustique / plastique, blanc

L 300, B 150, H 425, Base: B 110, T 150



1x 12W  
1x  
1700lm

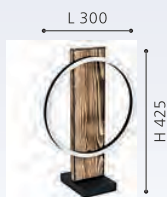

L 300

B 110

H 425

### 99408 BOYAL

ceiling light; steel, wood, black, brown rustic / plastic, white  
Deckenleuchte; Stahl, Holz, schwarz, braun rustikal / Kunststoff, weiss  
plafonnier; acier, bois, noir, marron rustique / plastique, blanc

L 780, B 400, H 90



1x 12W  
1x  
1700lm  
1x 12W  
1x  
1700lm



L 780

B 400



9 002759 993535



9 002759 994570



9 002759 994082



99625



99468



99467



**99625 BOYAL**

pendant light; steel, black, brown / ceramics, white  
 Hängeleuchte; Stahl, schwarz, braun / Keramik, weiss  
 luminaire en suspension; acier, noir, marron / céramique, blanc

L 1010, B 400, H 1100

LED 12,5W 1800lm warm WHITE LED 12,5W 1800lm warm WHITE LED 15,5W

warm WHITE 2250lm



9 002759 996253



**99468 BOYAL**

ceiling light; steel, wood, black, brown / plastic, white  
 Deckenleuchte; Stahl, Holz, schwarz, braun / Kunststoff, weiss  
 plafonnier; acier, bois, noir, marron / plastique, blanc

L 1010, B 400, H 95

LED 2x 12W 1700lm warm WHITE LED 1x 12W 1700lm



9 002759 994686

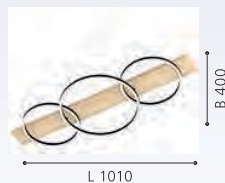

**99467 BOYAL**

ceiling light; steel, wood, black, brown / plastic, white  
 Deckenleuchte; Stahl, Holz, schwarz, braun / Kunststoff, weiss  
 plafonnier; acier, bois, noir, marron / plastique, blanc

L 780, B 400, H 90

LED 1x 12W 1700lm warm WHITE LED 1x 12W 1700lm



9 002759 994679

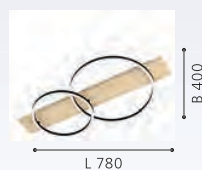



99469

LED

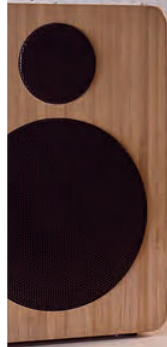

99466

LED

### 99469 BOYAL

table light; steel, wood, black, brown / plastic, white  
Tischleuchte; Stahl, Holz, schwarz, braun / Kunststoff, weiss  
luminaire de table; acier, bois, noir, marron / plastique, blanc

L 300, B 150, H 425, Base: B 110, T 150



1x 12W



1x  
1700lm



9 002759 994693



B 110

### 99466 BOYAL

wall light; steel, wood, black, brown / plastic, white  
Wandleuchte; Stahl, Holz, schwarz, braun / Kunststoff, weiss  
applique; acier, bois, noir, marron / plastique, blanc

L 300, H 560, A 75



1x 12W



1x  
1700lm



9 002759 994662

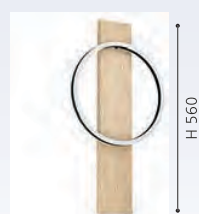

L 300





**39753**



**39752**

### 39753 AZBARREN

table light; steel, beige / ceramics, grey  
Tischleuchte; Stahl, beige / Keramik, grau  
luminaire de table; acier, beige / céramique, gris

H 535, Ø 300, Base: Ø 145



E27 1x 40 W



9 002759 397531



### 39752 AZBARREN

pendant light; steel, beige / ceramics, grey  
Hängeleuchte; Stahl, beige / Keramik, grau  
luminaire en suspension; acier, beige / céramique, gris

L 1195, B 145, H 1500



E27 4x 40 W



9 002759 397524



### 39751 AZBARREN

pendant light; steel, beige / ceramics, grey  
Hängeleuchte; Stahl, beige / Keramik, grau  
luminaire en suspension; acier, beige / céramique, gris

H 1500, Ø 145



E27 1x 40 W



9 002759 397517

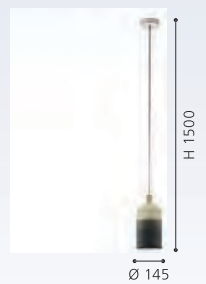



**39751**





95526



95525

95527

### 95526 TAREGA

pendant light; steel, grey / wood, concrete, brown, grey  
 Hängeleuchte; Stahl, grau / Holz, Beton, braun, grau  
 luminaire en suspension; acier, gris / bois, béton, marron, gris

H 1500, Ø 250



E27 3x 40W

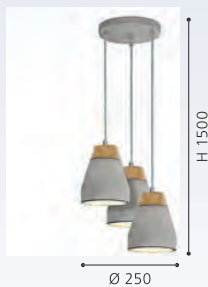

### 95525 TAREGA

pendant light; steel, grey / wood, concrete, brown, grey  
 Hängeleuchte; Stahl, grau / Holz, Beton, braun, grau  
 luminaire en suspension; acier, gris / bois, béton, marron, gris

H 1100, Ø 150



E27 1x 40W

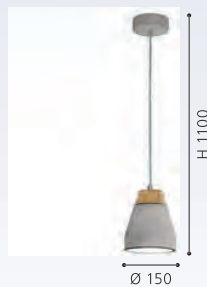

### 95527 TAREGA

table light; wood, concrete, brown, grey / fabric, brown  
 Tischleuchte; Holz, Beton, braun, grau / Textil, braun  
 luminaire de table; bois, béton, marron, gris / tissu, marron

H 370, Ø 250, Base: Ø 150

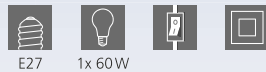

E27 1x 60W





**99513**



**99512**

### 99513 ABREOSA

floor light; steel, black, grey  
Stehleuchte; Stahl, schwarz, grau  
lampadaire; acier, noir, gris

L 370, B 280, H 1510, Base: Ø 250



E27 1x 28W



9 002759 995133

### 99512 ABREOSA

pendant light; steel, black, grey  
Hängeleuchte; Stahl, schwarz, grau  
luminaire en suspension; acier, noir, gris

L 1080, B 280, H 1100



E27 3x 28W



9 002759 995126

### 99511 ABREOSA

pendant light; steel, black, grey  
Hängeleuchte; Stahl, schwarz, grau  
luminaire en suspension; acier, noir, gris

H 1100, Ø 280



E27 1x 28W



9 002759 995119



99511





99551



99552



99553

### 99551 CASIBARE

pendant light; steel, black  
Hängeleuchte; Stahl, schwarz  
luminaire en suspension; acier, noir

H 1100, Ø 150



9 002759 995515



### 99552 CASIBARE

pendant light; steel, black  
Hängeleuchte; Stahl, schwarz  
luminaire en suspension; acier, noir

L 850, B 150, H 1100



9 002759 995522



### 99553 CASIBARE

pendant light; steel, black  
Hängeleuchte; Stahl, schwarz  
luminaire en suspension; acier, noir

H 1500, Ø 710

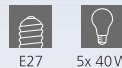

9 002759 995539





99554

### 99554 CASIBARE

table light; steel, black  
Tischleuchte; Stahl, schwarz  
luminaire de table; acier, noir

L 160, B 120, H 490, Base: Ø 155



E27 1x 28W



9 002759 995546



99555

### 99555 CASIBARE

floor light; steel, black  
Stehleuchte; Stahl, schwarz  
lampadaire; acier, noir

L 350, B 120, H 1605, Base: Ø 250



E27 2x 28W



9 002759 995553



97605

LED



97804

LED



97805

LED

### 97605 CORTADERAS

pendant light; steel, black, gold  
Hängeleuchte; Stahl, schwarz, gold  
luminaire en suspension; acier, noir, or

L 1130, B 85, H 1500



GU10



4x 5W



4x

400lm



H 1500

L 1130



9 002759 976057



### 97805 CORTADERAS

table light; steel, black, gold  
Tischleuchte; Stahl, schwarz, gold  
luminaire de table; acier, noir, or

L 235, B 150, H 445, Base: Ø 150



GU10



1x 5W



1x

400lm

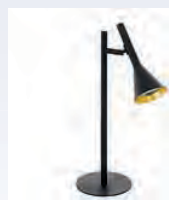

H 445

Ø 150



9 002759 978051



### 97804 CORTADERAS

wall light; steel, black, gold  
Wandleuchte; Stahl, schwarz, gold  
applique; acier, noir, or

H 200, Ø 120



GU10



1x 5W



1x

400lm



H 200

Ø 120



9 002759 978044







97604

LED

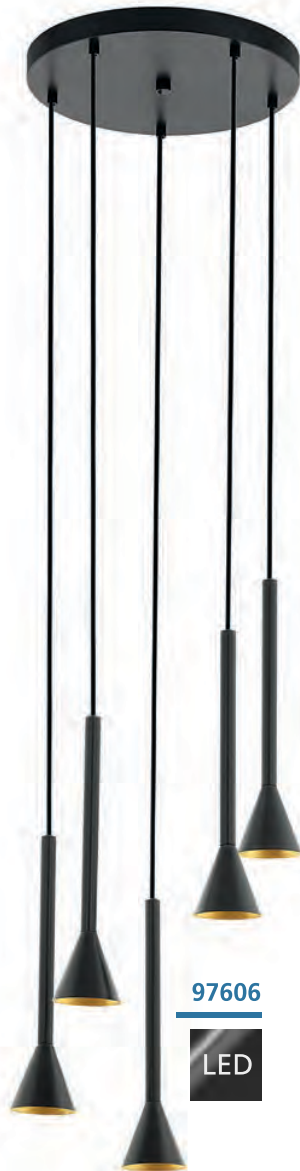

97606

LED



97806

LED

### 97604 CORTADERAS

pendant light; steel, black, gold  
Hängeleuchte; Stahl, schwarz, gold  
luminaire en suspension; acier, noir, or

H 1500, Ø 95



GU10



1x 5W



warm  
WHITE

1x

400lm



H 1500

Ø 95



9 002759 976040



### 97606 CORTADERAS

pendant light; steel, black, gold  
Hängeleuchte; Stahl, schwarz, gold  
luminaire en suspension; acier, noir, or

H 1500, Ø 350



GU10



5x 5W



warm  
WHITE

5x

400lm



H 1500

Ø 350



9 002759 976064



### 97806 CORTADERAS

floor light; steel, black, gold  
Stehleuchte; Stahl, schwarz, gold  
lampadaire; acier, noir, or

H 1445, Ø 250, Base: Ø 250



GU10



2x 5W



warm  
WHITE

2x

400lm



H 1445

Ø 250



9 002759 978068





99592



DESIGN  
HIGHLIGHT  
DETAIL

### 99592 NARICES

pendant light; steel, black / steel, brushed brass, gold  
Hängeleuchte; Stahl, schwarz / Stahl, messing-gebürstet, gold  
luminaire en suspension; acier, noir / acier, laiton brossé, or

L 920, B 220, H 1100



E27



3x 40W



9 002759 995928





99591



99593



99594

### 99591 NARICES

pendant light; steel, black / steel, brushed brass, gold  
Hängeleuchte; Stahl, schwarz / Stahl, messing-gebürstet, gold  
luminaire en suspension; acier, noir / acier, laiton brossé, or

H 1100, Ø 220



E27 1x 40W



9 002759 995911



### 99593 NARICES

table light; steel, black / steel, brushed brass, gold  
Tischleuchte; Stahl, schwarz / Stahl, messing-gebürstet, gold  
luminaire de table; acier, noir / acier, laiton brossé, or

L 295, B 220, H 500, Base: Ø 220



E27 1x 40W



9 002759 995935



### 99594 NARICES

floor light; steel, black / steel, brushed brass, gold  
Stehleuchte; Stahl, schwarz / Stahl, messing-gebürstet, gold  
lampadaire; acier, noir / acier, laiton brossé, or

L 295, B 220, H 1620, Base: Ø 270



E27 1x 40W



9 002759 995942





99806



99807



99809

### 99806 ESCANDIDOS

pendant light; steel, black, brass / steel, black, gold  
Hängeleuchte; Stahl, schwarz, messing / Stahl, schwarz, gold  
luminaire en suspension; acier, noir, laiton / acier, noir, or

H 1100, Ø 220



E27 1x 40W



9 002759 998066

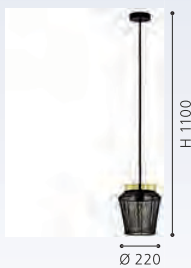

### 99807 ESCANDIDOS

pendant light; steel, black, brass / steel, black, gold  
Hängeleuchte; Stahl, schwarz, messing / Stahl, schwarz, gold  
luminaire en suspension; acier, noir, laiton / acier, noir, or

L 920, B 220, H 1100



E27 3x 40W



9 002759 998073



### 99809 ESCANDIDOS

floor light; steel, black, brass / steel, black, gold  
Stehleuchte; Stahl, schwarz, messing / Stahl, schwarz, gold  
lampadaire; acier, noir, laiton / acier, noir, or

L 310, B 220, H 1700, Base: B 300, T 200

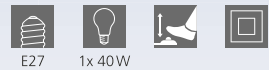

E27 1x 40W



9 002759 998097





99808

### 99808 ESCANDIDOS

table light; steel, black, brass / steel, black, gold  
Tischleuchte; Stahl, schwarz, messing / Stahl, schwarz, gold  
luminaire de table; acier, noir, laiton / acier, noir, or

H 260, Ø 220, Base: Ø 150



E27

1x 40 W



9 002759 998080



DESIGN  
HIGHLIGHT  
DETAIL



99098



99096



99097

### 99098 ERSEKA

pendant light; steel, brass / crystal, clear  
Hängeleuchte; Stahl, messing / Kristall, klar  
luminaire en suspension; acier, laiton / cristal, clair

H 1300, Ø 385



9 002759 990985

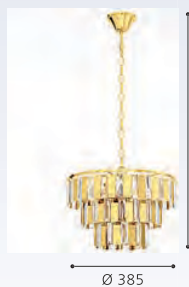

### 99097 ERSEKA

pendant light; steel, brass / crystal, clear  
Hängeleuchte; Stahl, messing / Kristall, klar  
luminaire en suspension; acier, laiton / cristal, clair

H 1450, Ø 485



9 002759 990978

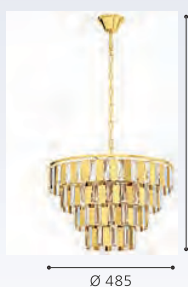

### 99096 ERSEKA

ceiling light; steel, brass / crystal, clear  
Deckenleuchte; Stahl, messing / Kristall, klar  
plafonnier; acier, laiton / cristal, clair

H 535, Ø 485



9 002759 990961

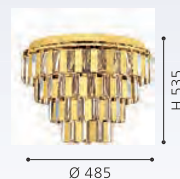



99095



99093



99094



EGLO  
RECOMMENDS  
**11704**

ERSEKA

### 99095 ERSEKA

pendant light; steel, chrome / crystal, clear  
Hängeleuchte; Stahl, chrom / Kristall, klar  
luminaire en suspension; acier, chrome / cristal, clair

H 1300, Ø 385



E14 5x 40W



9 002759 990954

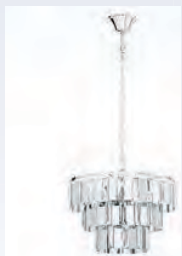

Ø 385

### 99094 ERSEKA

pendant light; steel, chrome / crystal, clear  
Hängeleuchte; Stahl, chrom / Kristall, klar  
luminaire en suspension; acier, chrome / cristal, clair

H 1450, Ø 485



E14 7x 40W



9 002759 990947

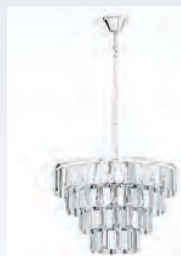

Ø 485

### 99093 ERSEKA

ceiling light; steel, chrome / crystal, clear  
Deckenleuchte; Stahl, chrom / Kristall, klar  
plafonnier; acier, chrome / cristal, clair

H 535, Ø 485



E14 7x 40W



9 002759 990930



Ø 485



95287

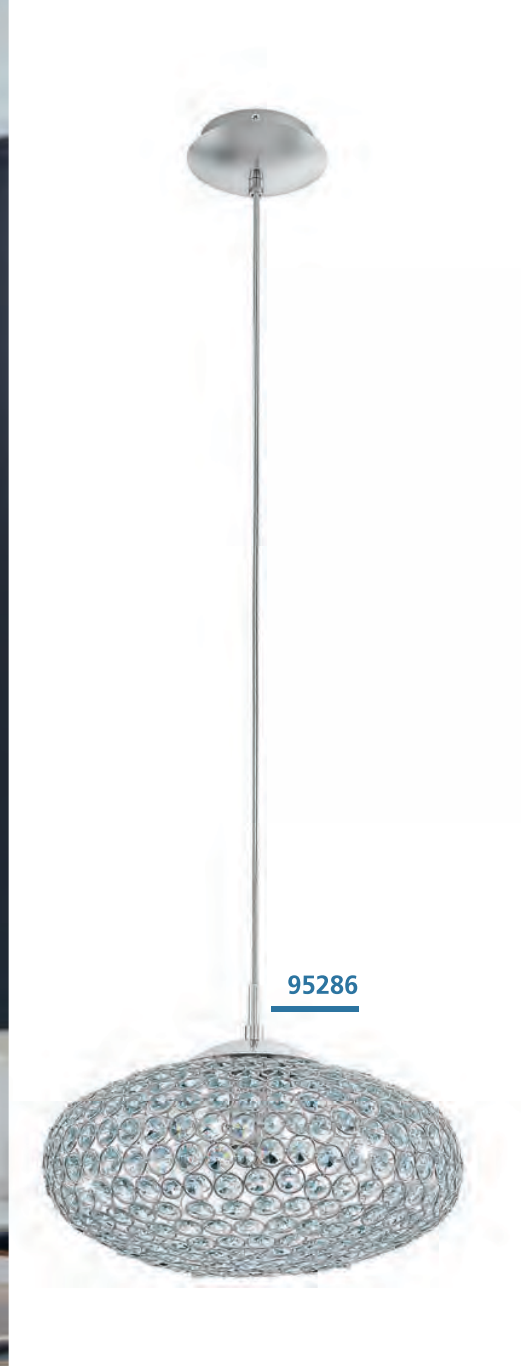

95286



DESIGN  
HIGHLIGHT  
DETAIL

### 95287 CLEMENTE

pendant light; steel, chrome / crystal, clear  
Hängeleuchte; Stahl, chrom / Kristall, klar  
luminaire en suspension; acier, chrome / cristal, clair

H 1100, Ø 540



E27



3x 60W



9 002759 952877

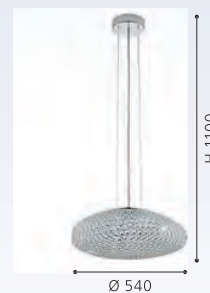





**95285**



**95284**

### 95286 CLEMENTE

pendant light; steel, chrome / crystal, clear  
Hängeleuchte; Stahl, chrom / Kristall, klar  
luminaire en suspension; acier, chrome / cristal, clair

H 1100, Ø 350



### 95284 CLEMENTE

ceiling light; steel, chrome / crystal, clear  
Deckenleuchte; Stahl, chrom / Kristall, klar  
plafonnier; acier, chrome / cristal, clair

H 200, Ø 350

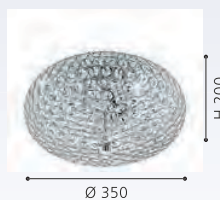

### 95285 CLEMENTE

ceiling light; steel, chrome / crystal, clear  
Deckenleuchte; Stahl, chrom / Kristall, klar  
plafonnier; acier, chrome / cristal, clair

H 205, Ø 450

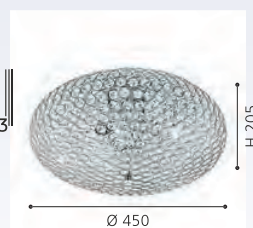



**94896**



**94899**



**BONARES 1**

### 94896 BONARES 1

pendant light; steel, chrome / steel, crystal, chrome, clear  
Hängeleuchte; Stahl, chrom / Stahl, Kristall, chrom, klar  
luminaire en suspension; acier, chrome / acier, cristal, chrome, clair

H 1100, Ø 130



E27



1x 60W



9 002759 948962



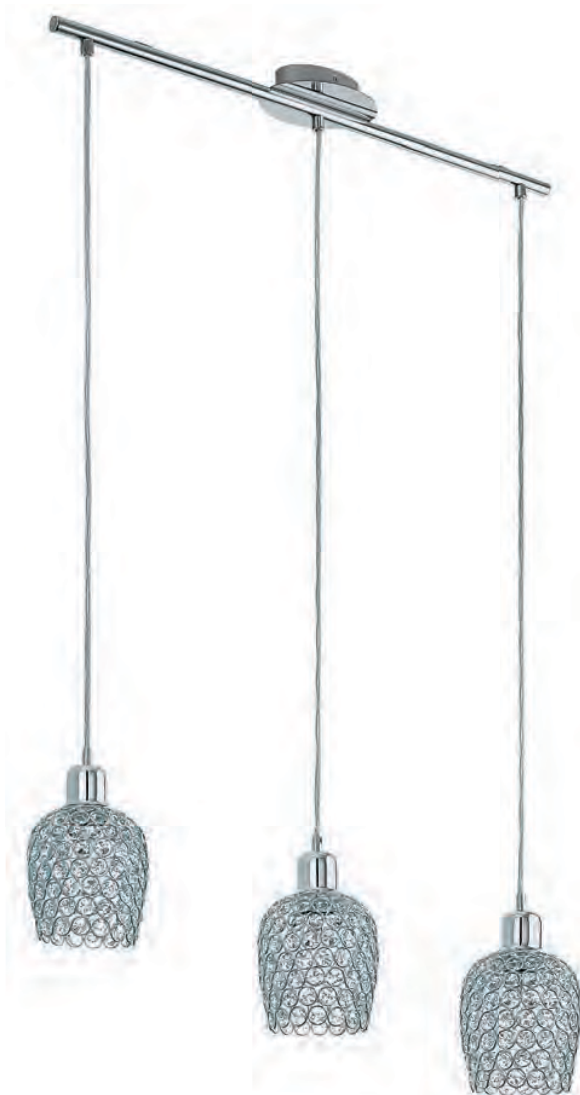

94897



94898

### 94899 BONARES 1

table light; steel, chrome / steel, crystal, chrome, clear  
Tischleuchte; Stahl, chrom / Stahl, Kristall, chrom, klar  
luminaire de table; acier, chrome / acier, cristal, chrome, clair

H 190, Ø 130, Base: Ø 120



E27 1x 60W



9 002759 948993



### 94897 BONARES 1

pendant light; steel, chrome / steel, crystal, chrome, clear  
Hängeleuchte; Stahl, chrom / Stahl, Kristall, chrom, klar  
luminaire en suspension; acier, chrome / acier, cristal, chrome, clair

L 745, B 130, H 1100



E27 3x 60W



9 002759 948979



### 94898 BONARES 1

pendant light; steel, chrome / steel, crystal, chrome, clear  
Hängeleuchte; Stahl, chrom / Stahl, Kristall, chrom, klar  
luminaire en suspension; acier, chrome / acier, cristal, chrome, clair

H 1500, Ø 350



E27 5x 60W



9 002759 948986

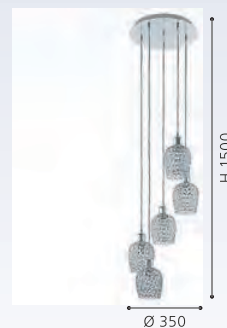



EGLO  
RECOMMENDS  
**11534**

98752



**98752**



**98753**



EGLO  
RECOMMENDS  
**11491**

98753 | 98754



**98754**

### 98752 GOROSIBA

pendant light; steel, black / glass vaporized, black-transparent  
Hängeleuchte; Stahl, schwarz / Glas bedampft, schwarz-transparent  
luminaire en suspension; acier, noir / verre vaporisé, noir transparent

H 1100, Ø 150



E27 1x 40W



Ø 150

H 1100



9 002759 987527

### 98753 GOROSIBA

pendant light; steel, black / glass vaporized, black-transparent  
Hängeleuchte; Stahl, schwarz / Glas bedampft, schwarz-transparent  
luminaire en suspension; acier, noir / verre vaporisé, noir transparent

L 850, B 150, H 1100



E27 3x 40W



L 850

H 1100



9 002759 987534

### 98754 GOROSIBA

pendant light; steel, black / glass vaporized, black-transparent  
Hängeleuchte; Stahl, schwarz / Glas bedampft, schwarz-transparent  
luminaire en suspension; acier, noir / verre vaporisé, noir transparent

H 1300, Ø 410



E27 3x 40W

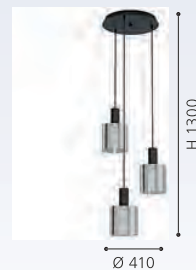

Ø 410

H 1300



9 002759 987541



**99372**

**99371**

**99374**

### 99371 MANTUNALLE 1

pendant light; steel, black / glass vaporized, black-transparent  
Hängeleuchte; Stahl, schwarz / Glas bedampft, schwarz-transparent  
luminaire en suspension; acier, noir / verre vaporisé, noir transparent

H 1100, Ø 200



### 99372 MANTUNALLE 1

pendant light; steel, black / glass vaporized, black-transparent  
Hängeleuchte; Stahl, schwarz / Glas bedampft, schwarz-transparent  
luminaire en suspension; acier, noir / verre vaporisé, noir transparent

L 1200, B 200, H 1100



### 99374 MANTUNALLE 1

table light; steel, black / glass vaporized, black-transparent  
Tischleuchte; Stahl, schwarz / Glas bedampft, schwarz-transparent  
luminaire de table; acier, noir / verre vaporisé, noir transparent

H 400, Ø 200, Base: Ø 220

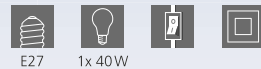

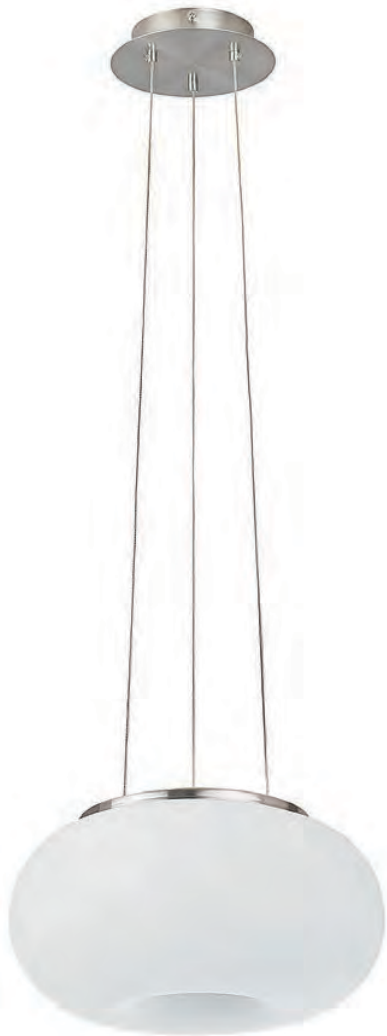

**86813**



**86814**



86813 | 86814 | 86815

**86813 OPTICA**

pendant light; steel, satin nickel / glass opal-matt, white  
 Hängeleuchte; Stahl, nickel-matt / Glas opal-matt, weiss  
 luminaire en suspension; acier, nickel mat / verre opale mat, blanc

H 1100, Ø 280



E27



2x 60W

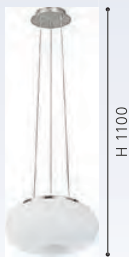

H 1100

Ø 280

**86814 OPTICA**

pendant light; steel, satin nickel / glass opal-matt, white  
 Hängeleuchte; Stahl, nickel-matt / Glas opal-matt, weiss  
 luminaire en suspension; acier, nickel mat / verre opale mat, blanc

H 1100, Ø 350



E27



2x 60W



H 1100

Ø 350



9 002759 868147

**86815 OPTICA**

pendant light; steel, satin nickel / glass opal-matt, white  
 Hängeleuchte; Stahl, nickel-matt / Glas opal-matt, weiss  
 luminaire en suspension; acier, nickel mat / verre opale mat, blanc

H 1100, Ø 445



E27



2x 60W

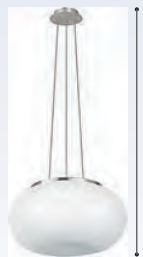

H 1100

Ø 445



9 002759 868154



86815





**86811**



**86812**



86811 | 86812 | 86816 |  
86817



**86816**

### 86811 OPTICA

wall / ceiling light; steel, satin nickel / glass opal-matt, white  
Wand- / Deckenleuchte; Stahl, nickel-matt / Glas opal-matt, weiss  
applique / plafonnier; acier, nickel mat / verre opale mat, blanc

H 160, Ø 280



E27 2x 60W

### 86812 OPTICA

wall / ceiling light; steel, satin nickel / glass opal-matt, white  
Wand- / Deckenleuchte; Stahl, nickel-matt / Glas opal-matt, weiss  
applique / plafonnier; acier, nickel mat / verre opale mat, blanc

H 210, Ø 350



E27 2x 60W

### 86816 OPTICA

table light; steel, satin nickel / glass opal-matt, white  
Tischleuchte; Stahl, nickel-matt / Glas opal-matt, weiss  
luminaire de table; acier, nickel mat / verre opale mat, blanc

H 460, Ø 280

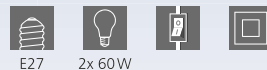

E27 2x 60W



9 002759 868116

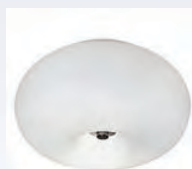

Ø 280



9 002759 868123

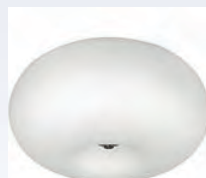

Ø 350



9 002759 868161



H 460





### 86817 OPTICA

floor light; steel, satin nickel / glass opal-matt, white  
Stehleuchte; Stahl, nickel-matt / Glas opal-matt, weiss  
lampadaire; acier, nickel mat / verre opale mat, blanc

H 1570, Ø 350



E27



2x 60W



9 002759 868178

86817



85261



85262

### 85261 RONDO

pendant light; steel, satin nickel / glass opal-matt, white  
 Hängeleuchte; Stahl, nickel-matt / Glas opal-matt, weiss  
 luminaire en suspension; acier, nickel mat / verre opale mat, blanc

H 1100, Ø 200



E27



1x 60W



9 002759 852610



H 1100

Ø 200

### 85262 RONDO

pendant light; steel, satin nickel / glass opal-matt, white  
 Hängeleuchte; Stahl, nickel-matt / Glas opal-matt, weiss  
 luminaire en suspension; acier, nickel mat / verre opale mat, blanc

H 1100, Ø 250



E27



1x 60W



9 002759 852627

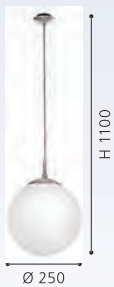

H 1100

Ø 250



**85263**



**91589**

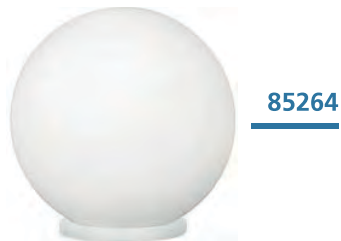

**85264**



EGLO  
RECOMMENDS  
**11596**

RONDO

### 85263 RONDO

pendant light; steel, satin nickel / glass opal-matt, white  
Hängeleuchte; Stahl, nickel-matt / Glas opal-matt, weiss  
luminaire en suspension; acier, nickel mat / verre opale mat, blanc

H 1100, Ø 300



E27 1x 60W



9 002759 852634



### 91589 RONDO

ceiling light; steel, satin nickel / glass opal-matt, white  
Deckenleuchte; Stahl, nickel-matt / Glas opal-matt, weiss  
plafonnier; acier, nickel mat / verre opale mat, blanc

H 315, Ø 250



E27 1x 60W



9 002759 915896



### 85264 RONDO

table light; plastic, white / glass opal-matt, white  
Tischleuchte; Kunststoff, weiss / Glas opal-matt, weiss  
luminaire de table; plastique, blanc / verre opale mat, blanc

H 200, Ø 200

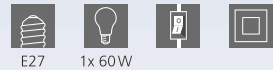

E27 1x 60W



9 002759 852641



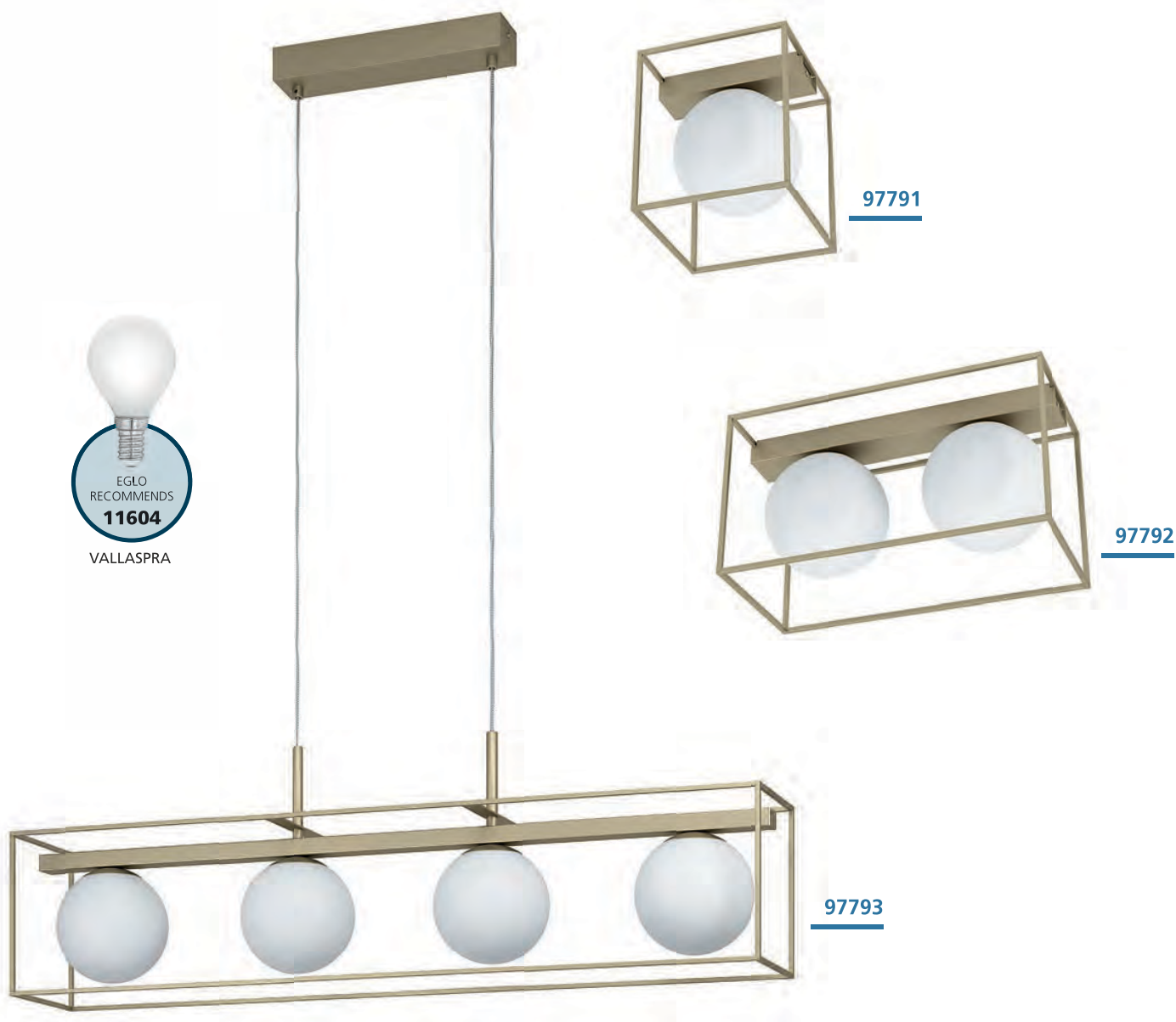

### 97793 VALLASPRA

pendant light; steel, champagne / glass opal-matt, white  
 Hängeleuchte; Stahl, champagner / Glas opal-matt, weiss  
 luminaire en suspension; acier, champagne / verre opale mat, blanc

L 910, B 165, H 1100



9 002759 977931

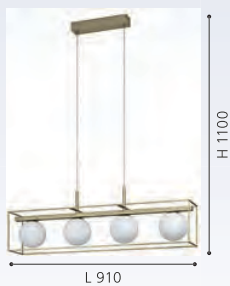

### 97791 VALLASPRA

wall / ceiling light; steel, champagne / glass opal-matt, white  
 Wand- / Deckenleuchte; Stahl, champagner / Glas opal-matt, weiss  
 applique / plafonnier; acier, champagne / verre opale mat, blanc

L 165, B 165, H 190



9 002759 977917

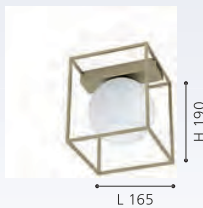

### 97792 VALLASPRA

wall / ceiling light; steel, champagne / glass opal-matt, white  
 Wand- / Deckenleuchte; Stahl, champagner / Glas opal-matt, weiss  
 applique / plafonnier; acier, champagne / verre opale mat, blanc

L 350, B 165, H 190



9 002759 977924





### 97794 VALLASPRA

table light; steel, champagne / glass opal-matt, white  
Tischleuchte; Stahl, champagner / Glas opal-matt, weiss  
luminaire de table; acier, champagne / verre opale mat, blanc

L 165, B 165, H 190



E14



1x 40W



9 002759 977948



L 165

H 190

97794



99288



99285 | 99288



99285



99286

### 99288 PINTO TEXTIL

wall light; steel, satin nickel / glass, fabric, clear, grey  
Wandleuchte; Stahl, nickel-matt / Glas, Textil, klar, grau  
applique; acier, nickel mat / verre, tissu, clair, gris

L 120, H 445, A 180



E27



1x 16W



9 002759 992880



L 120

H 445

A 180

### 99285 PINTO TEXTIL

pendant light; steel, satin nickel / glass, fabric, clear, grey  
Hängeleuchte; Stahl, nickel-matt / Glas, Textil, klar, grau  
luminaire en suspension; acier, nickel mat / verre, tissu, clair, gris

H 1100, Ø 120



E27



1x 16W



9 002759 992859

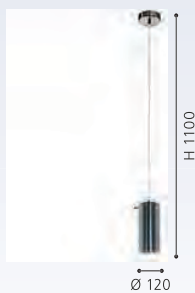

H 1100

Ø 120

### 99286 PINTO TEXTIL

pendant light; steel, satin nickel / glass, fabric, clear, grey  
Hängeleuchte; Stahl, nickel-matt / Glas, Textil, klar, grau  
luminaire en suspension; acier, nickel mat / verre, tissu, clair, gris

L 820, B 120, H 1100



E27



3x 16W



9 002759 992866



H 1100

L 820



90304



90304 | 90305

### 90304 PINTO NERO

pendant light; steel, satin nickel / smoked glass, glass opal-matt, black-transparent, white

Hängeleuchte; Stahl, nickel-matt / Rauchglas, Glas opal-matt, schwarz-transparent, weiss

luminaire en suspension; acier, nickel mat / verre fumé, verre opale mat, noir transparent, blanc

H 1100, Ø 110



E27



1x 40W



9 002759 903046



### 90305 PINTO NERO

pendant light; steel, satin nickel / smoked glass, glass opal-matt, black-transparent, white

Hängeleuchte; Stahl, nickel-matt / Rauchglas, Glas opal-matt, schwarz-transparent, weiss

luminaire en suspension; acier, nickel mat / verre fumé, verre opale mat, noir transparent, blanc

L 725, H 1100



E27



3x 40W



9 002759 903053





90305





**97653**



**97651**



**97839**

### 97653 PINTO GOLD

pendant light; steel, black / glass, clear, gold  
 Hängeleuchte; Stahl, schwarz / Glas, klar, gold  
 luminaire en suspension; acier, noir / verre, clair, or

L 905, B 360, H 1100



E27



4x 40W



9 002759 976538

### 97651 PINTO GOLD

pendant light; steel, black / glass, clear, gold  
 Hängeleuchte; Stahl, schwarz / Glas, klar, gold  
 luminaire en suspension; acier, noir / verre, clair, or

H 1100, Ø 110



E27



1x 40W



9 002759 976514

### 97839 PINTO GOLD

wall light; steel, black / glass, clear, gold  
 Wandleuchte; Stahl, schwarz / Glas, klar, gold  
 applique; acier, noir / verre, clair, or

L 110, H 270, A 150



E27



1x 40W



9 002759 978396



97652



97655



PINTO GOLD



### 97652 PINTO GOLD

pendant light; steel, black / glass, clear, gold  
 Hängeleuchte; Stahl, schwarz / Glas, klar, gold  
 luminaire en suspension; acier, noir / verre, clair, or

L 725, B 110, H 1100



### 97655 PINTO GOLD

floor light; steel, black, gold / glass, clear, gold  
 Stehleuchte; Stahl, schwarz, gold / Glas, klar, gold  
 lampadaire; acier, noir, or / verre, clair, or

H 1470, Ø 110, Base: Ø 230

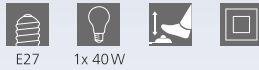



**89834**



89832 | 89833 | 89834 |  
89835 | 89836



**89832**



**89835**

### 89834 PINTO

pendant light; steel, chrome / glass, glass opal-matt, clear, white  
Hängeleuchte; Stahl, chrom / Glas, Glas opal-matt, klar, weiss  
luminaire en suspension; acier, chrome / verre, verre opale mat, clair, blanc

L 905, B 360, H 1100



E27 4x 40W



9 002759 898342

### 89835 PINTO

table light; steel, chrome / glass, glass opal-matt, clear, white  
Tischleuchte; Stahl, chrom / Glas, Glas opal-matt, klar, weiss  
luminaire de table; acier, chrome / verre, verre opale mat, clair, blanc

H 500, Ø 110, Base: Ø 155

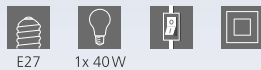

E27 1x 40W



9 002759 898359

### 89832 PINTO

pendant light; steel, chrome / glass, glass opal-matt, clear, white  
Hängeleuchte; Stahl, chrom / Glas, Glas opal-matt, klar, weiss  
luminaire en suspension; acier, chrome / verre, verre opale mat, clair, blanc

H 1100, Ø 110



E27 1x 40W



9 002759 898328



**93003**



**89833**



**89836**

### 93003 PINTO

pendant light; steel, chrome / glass, glass opal-matt, clear, white  
Hängeleuchte; Stahl, chrom / Glas, Glas opal-matt, klar, weiss  
luminaire en suspension; acier, chrome / verre, verre opale mat, clair, blanc

H 1500, Ø 500



E27 5x 40W



9 002759 930035



### 89833 PINTO

pendant light; steel, chrome / glass, glass opal-matt, clear, white  
Hängeleuchte; Stahl, chrom / Glas, Glas opal-matt, klar, weiss  
luminaire en suspension; acier, chrome / verre, verre opale mat, clair, blanc

L 725, H 1100



E27 3x 40W



9 002759 898335



### 89836 PINTO

floor light; steel, chrome / glass, glass opal-matt, clear, white  
Stehleuchte; Stahl, chrom / Glas, Glas opal-matt, klar, weiss  
lampadaire; acier, chrome / verre, verre opale mat, clair, blanc

H 1470, Ø 110, Base: Ø 230



E27 1x 40W



9 002759 898366





**85978**



**85977**

**85978 TROY 3**

pendant light; steel, satin nickel / satin glass, white painted  
 Hängeleuchte; Stahl, nickel-matt / Glas satiniert, weiss lackiert  
 luminaire en suspension; acier, nickel mat / verre satiné, blanc laqué

L 720, B 105, H 1100



9 002759 859787



**85977 TROY 3**

pendant light; steel, satin nickel / satin glass, white painted  
 Hängeleuchte; Stahl, nickel-matt / Glas satiniert, weiss lackiert  
 luminaire en suspension; acier, nickel mat / verre satiné, blanc laqué

H 1100, Ø 110



9 002759 859770



**85979 TROY 3**

wall light; steel, satin nickel / satin glass, white  
 Wandleuchte; Stahl, nickel-matt / Glas satiniert, weiss  
 applique; acier, nickel mat / verre satiné, blanc laqué

L 180, H 250, A 75



9 002759 859794





**85979**



85979



**85981**



85977 | 85978 | 85981 |  
85982

### 85981 TROY 3

table light; steel, satin nickel / satin glass, white painted  
Tischleuchte; Stahl, nickel-matt / Glas satiniert, weiss lackiert  
luminaire de table; acier, nickel mat / verre satiné, blanc laqué

H 460, Ø 105, Base: Ø 120



E27 1x 40W



9 002759 859817



### 85982 TROY 3

floor light; steel, satin nickel / satin glass, white painted  
Stehleuchte; Stahl, nickel-matt / Glas satiniert, weiss lackiert  
lampadaire; acier, nickel mat / verre satiné, blanc laqué

H 1530, Ø 105, Base: Ø 200

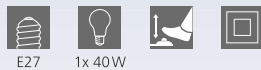

E27 1x 40W



9 002759 859824



**85982**



92739

### 92739 RIVATO

pendant light; steel, chrome / glass with decor, white, chrome  
 Hängeleuchte; Stahl, chrom / Glas mit Dekor, weiss, chrom  
 luminaire en suspension; acier, chrome / verre avec décor, blanc, chrome

H 1100, Ø 90



9 002759 927394



H 1100

Ø 90



92741

### 92741 RIVATO

pendant light; steel, chrome / glass with decor, white, chrome  
 Hängeleuchte; Stahl, chrom / Glas mit Dekor, weiss, chrom  
 luminaire en suspension; acier, chrome / verre avec décor, blanc, chrome

L 705, B 90, H 1100



9 002759 927417



H 1100

L 705



92742



92742

### 92742 RIVATO

wall light; steel, white, chrome / glass with decor, white, chrome  
 Wandleuchte; Stahl, weiss, chrom / Glas mit Dekor, weiss, chrom  
 applique; acier, blanc, chrome / verre avec décor, blanc, chrome

L 180, H 250, A 80



9 002759 927424



H 250

L 180



**90048**



**90049**



90049

**90048 AMADORA**

pendant light; steel, satin nickel / glass printed, white  
 Hängeleuchte; Stahl, nickel-matt / Glas bedruckt, weiss  
 luminaire en suspension; acier, nickel mat / verre imprimé, blanc

L 720, B 105, H 1100



**90049 AMADORA**

wall light; steel, satin nickel / glass printed, white  
 Wandleuchte; Stahl, nickel-matt / Glas bedruckt, weiss  
 applique; acier, nickel mat / verre imprimé, blanc

L 180, H 250, A 75

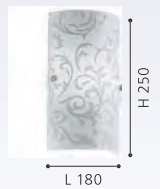





91005



91006



91007



### MURCIA, VINOVO

These luminaires come with high quality processed alabaster glass.

Diese Leuchten sind mit hochwertigem Alabasterglas ausgestattet.

Ces luminaires viennent avec un abat-jour en verre d'albâtre haut de gamme.

### 91005 MURCIA

pendant light; steel, black / glass alabaster, white  
Hängeleuchte; Stahl, schwarz / Glas alabaster, weiss  
luminaire en suspension; acier, noir / verre albâtre, blanc

H 1100, Ø 630



E27 3x 60W



9 002759 910051



H 1100

Ø 630

### 91006 MURCIA

wall light; steel, black / glass alabaster, white  
Wandleuchte; Stahl, schwarz / Glas alabaster, weiss  
applique; acier, noir / verre albâtre, blanc

L 165, H 190, A 230



E14 1x 40W



9 002759 910068

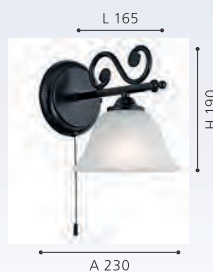

L 165

H 190

A 230

### 91007 MURCIA

table light; steel, black / glass alabaster, white  
Tischleuchte; Stahl, schwarz / Glas alabaster, weiss  
luminaire de table; acier, noir / verre albâtre, blanc

L 165, H 370, Base: Ø 150



E14 1x 40W



9 002759 910075



L 165

H 370

Ø 150



82748



82749



DESIGN  
HIGHLIGHT  
DETAIL

### 82748 SAVOY

pendant light; cast metal, bronzed / satin glass, white  
Hängeleuchte; Metallguss, brüniert / Glas satiniert, weiss  
luminaire en suspension; fonte métallique, bruni / verre satiné, blanc

H 1100, Ø 740



E14



3x 40W



E27



2x 60W



9 002759 827489

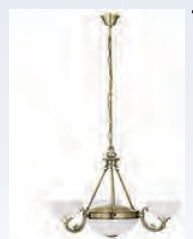

H 1100

Ø 740

### 82749 SAVOY

pendant light; cast metal, bronzed / satin glass, white  
Hängeleuchte; Metallguss, brüniert / Glas satiniert, weiss  
luminaire en suspension; fonte métallique, bruni / verre satiné, blanc

H 1100, Ø 740



E14



6x 40W



E27



2x 60W



9 002759 827496

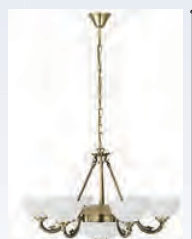

H 1100

Ø 740



82751



82752



82747

### 82751 SAVOY

wall light; cast metal, bronzed / satin glass, white  
Wandleuchte; Metallguss, brüniert / Glas satiniert, weiss  
applique; fonte métallique, bruni / verre satiné, blanc

L 180, H 160, A 240



E14 1x 40W



9 002759 827519



### 82752 SAVOY

wall light; cast metal, bronzed / satin glass, white  
Wandleuchte; Metallguss, brüniert / Glas satiniert, weiss  
applique; fonte métallique, bruni / verre satiné, blanc

L 410, H 160, A 210



E14 2x 40W



9 002759 827526

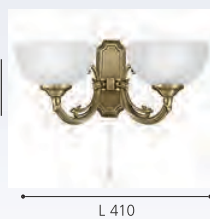

### 82747 SAVOY

pendant light; cast metal, bronzed / satin glass, white  
Hängeleuchte; Metallguss, brüniert / Glas satiniert, weiss  
luminaire en suspension; fonte métallique, bruni / verre satiné, blanc

H 1100, Ø 310



E27 2x 60W



9 002759 827472





85856



85857



85859

### 85856 MARBELLA

ceiling light; cast metal, bronzed / glass alabaster, champagne  
Deckenleuchte; Metallguss, brüniert / Glas alabaster, champagner  
plafonnier; fonte métallique, bruni / verre albâtre, champagne

H 410, Ø 370



E14



3x 60W



9 002759 858568

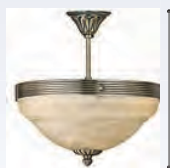

H 410

Ø 370

### 85857 MARBELLA

pendant light; cast metal, bronzed / glass alabaster, champagne  
Hängeleuchte; Metallguss, brüniert / Glas alabaster, champagner  
luminaire en suspension; fonte métallique, bruni / verre albâtre, champagne

H 1100, Ø 740



E14



6x 60W



9 002759 858575

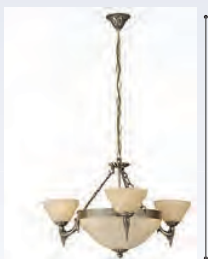

H 1100

Ø 740

### 85859 MARBELLA

wall light; cast metal, bronzed / glass alabaster, champagne  
Wandleuchte; Metallguss, brüniert / Glas alabaster, champagner  
applique; fonte métallique, bruni / verre albâtre, champagne

L 170, H 200, A 230



E14



1x 40W



9 002759 858599

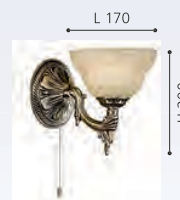

L 170

H 200

A 230



85858

## 85858 MARBELLA

pendant light; cast metal, bronzed / glass alabaster, champagne  
Hängeleuchte; Metallguss, brüniert / Glas alabaster, champagner  
luminaire en suspension; fonte métallique, bruni / verre albâtre, champagne

H 1100, Ø 740



E14



9x 60W



9 002759 858582

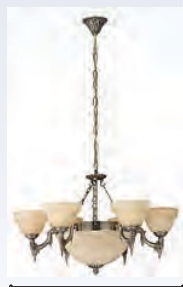

H 1100

Ø 740

## MARBELLA

These luminaires come with high quality processed alabaster glass.

Diese Leuchten sind mit hochwertigem Alabasterglas ausgestattet.

Ces luminaires viennent avec un abat-jour en verre d'albâtre haut de gamme.

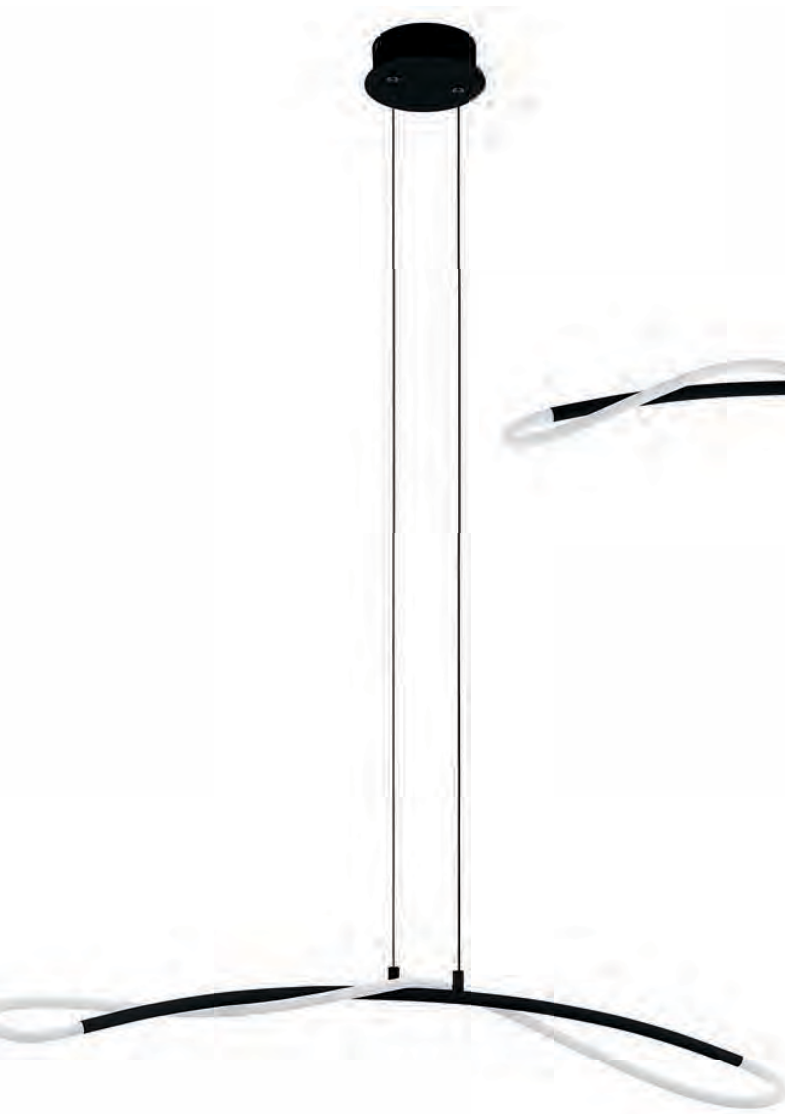

99382

LED



99381

LED

### 99382 EGIDONELLA

pendant light; steel, black / plastic, white  
Hängeleuchte; Stahl, schwarz / Kunststoff, weiss  
luminaire en suspension; acier, noir / plastique, blanc

L 900, B 140, H 1200



20W 3250lm



9 002759 993825

### 99381 EGIDONELLA

ceiling light; steel, black / plastic, white  
Deckenleuchte; Stahl, schwarz / Kunststoff, weiss  
plafonnier; acier, noir / plastique, blanc

L 900, B 140, H 210



20W 3250lm

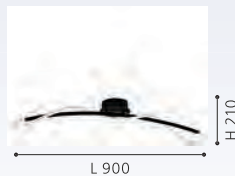

9 002759 993818

### 99383 EGIDONELLA

table light; steel, black / plastic, white  
Tischleuchte; Stahl, schwarz / Kunststoff, weiss  
luminaire de table; acier, noir / plastique, blanc

L 355, B 150, H 380, Base: Ø 150



5,5W 700lm



9 002759 993832



99383

LED

### 99384 EGIDONELLA

floor light; steel, black / plastic, white  
 Stehleuchte; Stahl, schwarz / Kunststoff, weiss  
 lampadaire; acier, noir / plastique, blanc

L 730, H 1600, Base: Ø 250

LED

20,5W

warm  
white

2750lm



L 730



Ø 250



9 002759 993849



99384

LED



98889

LED



99559

LED

### 98889 PALOZZA 1

wall light; aluminium, satin nickel / plastic, white  
Wandleuchte; Alu, nickel-matt / Kunststoff, weiss  
applique; aluminium, nickel mat / plastique, blanc

L 170, H 425, A 60



12 W 1200lm



9 002759 988890

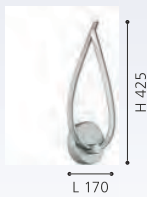

L 170

H 425

### 99559 PALOZZA 1

table light; aluminium, satin nickel / plastic, white  
Tischleuchte; Alu, nickel-matt / Kunststoff, weiss  
luminaire de table; aluminium, nickel mat / plastique, blanc

L 140, B 110, H 410



9,8 W 1000lm



9 002759 995591

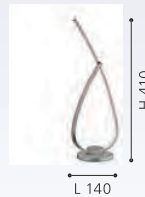

L 140

H 410

### 31997 RONCADE

table light; aluminium, steel, chrome / plastic, white  
Tischleuchte; Alu, Stahl, chrom / Kunststoff, weiss  
luminaire de table; aluminium, acier, chrome / plastique, blanc

L 195, B 150, H 335



14 W 1200lm



9 002759 319977



L 195

H 335





31997

LED

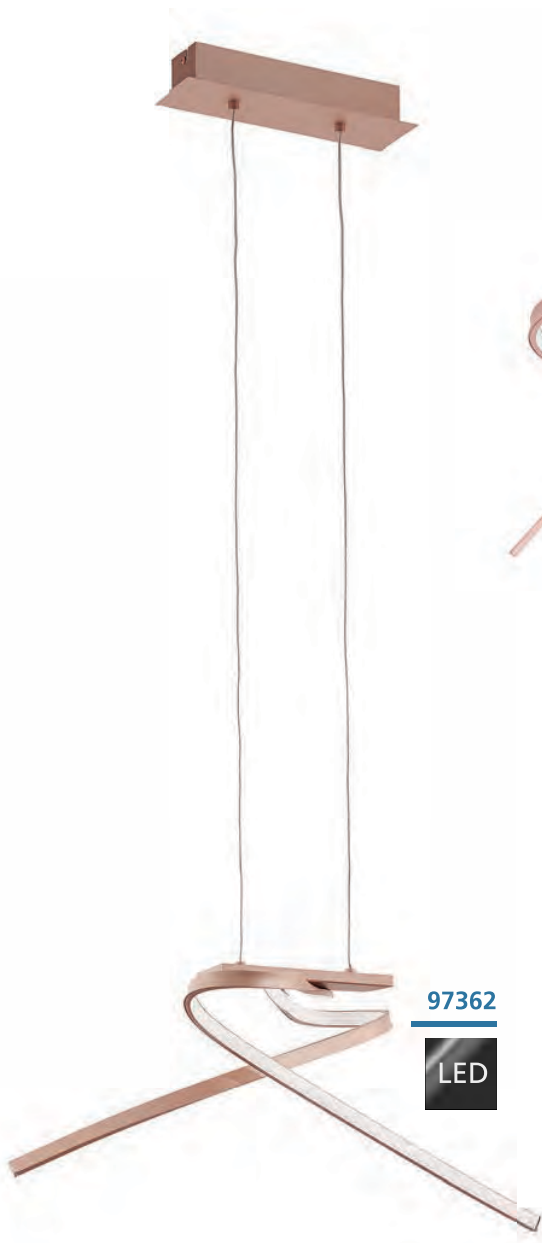

97362

LED



97361

LED



97363

LED

### 97362 PALOZZA

pendant light; aluminium, rose gold / plastic, white  
Hängeleuchte; Alu, roségold / Kunststoff, weiss  
luminaire en suspension; aluminium, or rose / plastique, blanc

L 705, B 315, H 1100



2x 11W  
2x  
1500lm



9 002759 973629



### 97361 PALOZZA

ceiling light; aluminium, rose gold / plastic, white  
Deckenleuchte; Alu, roségold / Kunststoff, weiss  
plafonnier; aluminium, or rose / plastique, blanc

L 705, B 315, H 125



2x 11W  
2x  
1500lm



9 002759 973612



### 97363 PALOZZA

wall light; aluminium, rose gold / plastic, white  
Wandleuchte; Alu, roségold / Kunststoff, weiss  
applique; aluminium, or rose / plastique, blanc

L 170, H 425, A 60



1x 11W  
1x  
1500lm



9 002759 973636





97365

LED

### 97365 PALOZZA

floor light; aluminium, rose gold / plastic, white  
 Stehleuchte; Alu, roségold / Kunststoff, weiss  
 lampadaire; aluminium, or rose / plastique, blanc

H 1175, Ø 220, Base: Ø 220



1x 25W  
 1x  
 3200lm



9 002759 973650



97364

LED

### 97364 PALOZZA

table light; aluminium, rose gold / plastic, white  
 Tischleuchte; Alu, roségold / Kunststoff, weiss  
 luminaire de table; aluminium, or rose / plastique, blanc

H 380, Ø 185, Base: Ø 150



1x 14W  
 1x  
 1600lm



9 002759 973643





### 97938 NOVAFELTRIA

pendant light; steel, aluminium, satin nickel / plastic, white  
 Hängeleuchte; Stahl, Alu, nickel-matt / Kunststoff, weiss  
 luminaire en suspension; acier, aluminium, nickel mat / plastique, blanc

L 900, B 200, H 1500

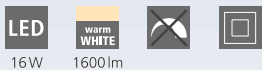

16W 1600lm



9 002759 979386



### 97937 NOVAFELTRIA

ceiling light; steel, aluminium, satin nickel / plastic, white  
 Deckenleuchte; Stahl, Alu, nickel-matt / Kunststoff, weiss  
 plafonnier; acier, aluminium, nickel mat / plastique, blanc

L 700, B 160, H 160



13W 1300lm



9 002759 979379



### 97941 NOVAFELTRIA

table light; steel, aluminium, satin nickel / plastic, white  
 Tischleuchte; Stahl, Alu, nickel-matt / Kunststoff, weiss  
 luminaire de table; acier, aluminium, nickel mat / plastique, blanc

L 160, B 160, H 410, Base: Ø 130



10W 1000lm



9 002759 979416





97941

LED

### 97939 NOVAFELTRIA

wall light; steel, aluminium, satin nickel / plastic, white  
Wandleuchte; Stahl, Alu, nickel-matt / Kunststoff, weiss  
applique; acier, aluminium, nickel mat / plastique, blanc

L 160, H 400, A 160

LED

10W

warm  
WHITE

1000lm



L 160

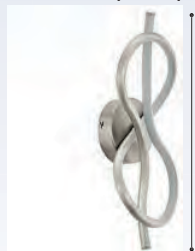

H 400

A 160



9 002759 979393



97939

LED

# LIGHTING FAMILIES

## GLASS CHANDELIERS

## GLASLUSTER

## LUSTRES EN VERRE

**SPARKLING** - Extravagant lighting – our glass chandeliers will give you light in a new diversity while ensuring an extraordinary ambience. Our chandeliers are true jewels on your ceiling and spread their elegance in your entire living area.

**FUNKELN** - Beleuchtung der Extravaganz – Mit unseren Glaslustern erleben Sie Licht in neuer Vielfalt und sorgen für ein außergewöhnliches Ambiente. Unsere Kronleuchter werden zum wahren Schmuckstück und bringen Eleganz in all Ihre Wohnbereiche.

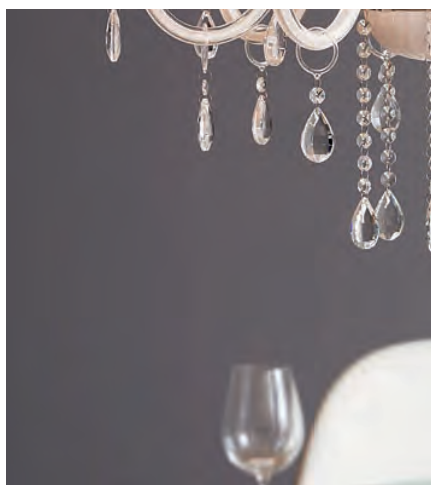

**DU SCINTILLEMENT** - Un éclairage riche en extravagance – Avec nos lustres en verre, vous faites l'expérience de la lumière dans une nouvelle multiplicité et vous assurez une ambiance extraordinaire. Nos plafonniers lustres en deviennent de vrais bijoux et prêtent de l'élégance à tous vos espaces d'habitat.









39103

39101

### 39103 BASILANO 1

pendant light; steel, chrome / glass, clear  
 Hängeleuchte; Stahl, chrom / Glas, klar  
 luminaire en suspension; acier, chrome / verre, clair

H 1500, Ø 1000



E14 18x 40W



9 002759 391034



H 1500

Ø 1000

### 39101 BASILANO 1

pendant light; steel, chrome / glass, clear  
 Hängeleuchte; Stahl, chrom / Glas, klar  
 luminaire en suspension; acier, chrome / verre, clair

H 1300, Ø 820

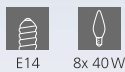

E14 8x 40W



9 002759 391010

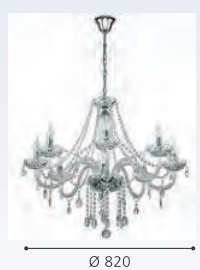

H 1300

Ø 820

### 39099 BASILANO 1

pendant light; steel, chrome / glass, clear  
 Hängeleuchte; Stahl, chrom / Glas, klar  
 luminaire en suspension; acier, chrome / verre, clair

H 1300, Ø 720



E14 6x 40W



9 002759 390990

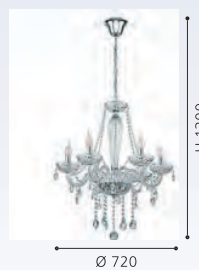

H 1300

Ø 720



39099



39102

### 39102 BASILANO 1

pendant light; steel, chrome / glass, clear  
Hängeleuchte; Stahl, chrom / Glas, klar  
luminaire en suspension; acier, chrome / verre, clair

H 1500, Ø 1000



E14



12x 40W



9 002759 391027



H 1500

Ø 1000



39095



39092

### 39095 BASILANO

pendant light; steel, chrome / glass, cognac  
 Hängeleuchte; Stahl, chrom / Glas, cognac  
 luminaire en suspension; acier, chrome / verre, cognac

H 1500, Ø 1000



E14 18x 40W



9 002759 390952



H 1500

Ø 1000

### 39092 BASILANO

pendant light; steel, chrome / glass, cognac  
 Hängeleuchte; Stahl, chrom / Glas, cognac  
 luminaire en suspension; acier, chrome / verre, cognac

H 1300, Ø 720



E14 6x 40W



9 002759 390921

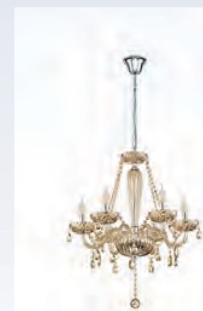

H 1300

Ø 720



39094

39093

### 39093 BASILANO

pendant light; steel, chrome / glass, cognac  
 Hängeleuchte; Stahl, chrom / Glas, cognac  
 luminaire en suspension; acier, chrome / verre, cognac

H 1300, Ø 820



E14



8x 40W



9 002759 390938



### 39094 BASILANO

pendant light; steel, chrome / glass, cognac  
 Hängeleuchte; Stahl, chrom / Glas, cognac  
 luminaire en suspension; acier, chrome / verre, cognac

H 1500, Ø 1000



E14



12x 40W



9 002759 390945

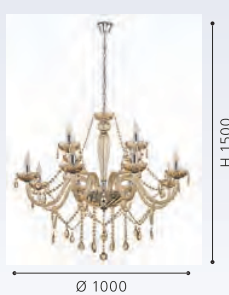



39114



# HANGING & PENDANT LUMINAIRES

HÄNGE- & PENDELLEUCHTEN  
LUMINAIRES SUSPENSIONS

## SUSPENDED LIGHTING -

Our wide variety of suspended and pendant luminaires contain classical as well as extravagant designs and supply any furnishing style. Set beautiful accents with your favourites and give your home a special atmosphere.

## BELEUCHTUNG ZUM ABHÄNGEN -

Unser breitgefächertes Hänge- und Pendelleuchten-Sortiment beinhaltet sowohl klassische als auch extravagante Designs und bedient jeden Einrichtungsstil. Setzen Sie mit Ihren Favoriten schöne Akzente und verleihen Sie Ihrem Zuhause eine besondere Atmosphäre.



## ÉCLAIRAGES SUSPENDUS -

Notre large gamme d'éclairages suspendus et pendulaires comprend aussi bien des designs classiques qu'extravagants et est adaptée à tout style d'ameublement. Mettez avec vos favoris de beaux accents et donnez une atmosphère particulière à votre intérieur.





### 99614 OILELLA

pendant light; steel, black, brass / glass vaporized, black-brown-transparent

Hängeleuchte; Stahl, schwarz, messing / Glas bedampft, schwarz-braun-transparent

luminaire en suspension; acier, noir, laiton / verre vaporisé, noir-marron-transparent

H 1100, Ø 190



E27 1x 40W



9 002759 996147

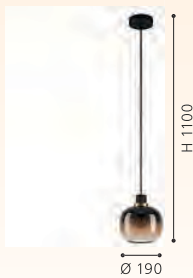

### 99615 OILELLA

pendant light; steel, black, brass / glass vaporized, black-brown-transparent

Hängeleuchte; Stahl, schwarz, messing / Glas bedampft, schwarz-braun-transparent

luminaire en suspension; acier, noir, laiton / verre vaporisé, noir-marron-transparent

L 950, B 190, H 1100



E27 3x 40W



9 002759 996154



### 99616 OILELLA

pendant light; steel, black, brass / glass vaporized, black-grey-transparent

Hängeleuchte; Stahl, schwarz, messing / Glas bedampft, schwarz-grau-transparent

luminaire en suspension; acier, noir, laiton / verre vaporisé, noir-gris-transparent

H 1100, Ø 190



E27 1x 40W



9 002759 996161







## 99617 OILELLA

pendant light; steel, black, brass / glass vaporized,  
black-grey-transparent

Hängeleuchte; Stahl, schwarz, messing / Glas bedampft,  
schwarz-grau-transparent

luminaire en suspension; acier, noir, laiton / verre vaporisé,  
noir-gris-transparent

L 950, B 190, H 1100



E27



3x 40W





98647



98648



98649



98647 | 98648 | 98649

### 98647 ALOBRASE

pendant light; steel, brushed brass / glass vaporized, amber  
Hängeleuchte; Stahl, messing-gebürstet / Glas bedampft, amber  
luminaire en suspension; acier, laiton brossé / verre vaporisé, ambre

H 1100, Ø 300



E27 1x 40W



9 002759 986476

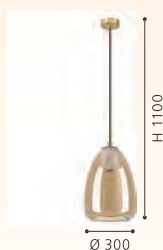

### 98648 ALOBRASE

pendant light; steel, brushed brass / glass vaporized, amber  
Hängeleuchte; Stahl, messing-gebürstet / Glas bedampft, amber  
luminaire en suspension; acier, laiton brossé / verre vaporisé, ambre

H 1100, Ø 200



E27 1x 40W



9 002759 986483



### 98649 ALOBRASE

pendant light; steel, brushed brass / glass vaporized, amber  
Hängeleuchte; Stahl, messing-gebürstet / Glas bedampft, amber  
luminaire en suspension; acier, laiton brossé / verre vaporisé, ambre

L 1080, B 150, H 1100



E27 4x 40W



9 002759 986490





98614

98616



98614 | 98615 | 98616 |  
98617

### 98614 ALOBRASE

pendant light; steel, chrome / glass vaporized, black-transparent  
Hängeleuchte; Stahl, chrom / Glas bedampft, schwarz-transparent  
luminaire en suspension; acier, chrome / verre vaporisé, noir transparent

H 1100, Ø 300



E27 1x 40W



9 002759 986148



### 98616 ALOBRASE

pendant light; steel, chrome / glass vaporized, black-transparent  
Hängeleuchte; Stahl, chrom / Glas bedampft, schwarz-transparent  
luminaire en suspension; acier, chrome / verre vaporisé, noir transparent

L 1080, B 150, H 1100



E27 4x 40W



9 002759 986162



### 98615 ALOBRASE

pendant light; steel, chrome / glass vaporized, black-transparent  
Hängeleuchte; Stahl, chrom / Glas bedampft, schwarz-transparent  
luminaire en suspension; acier, chrome / verre vaporisé, noir transparent

H 1100, Ø 200



E27 1x 40W



9 002759 986155





98615

### 98617 ALOBRASE

pendant light; steel, chrome / glass vaporized, black-transparent  
Hängeleuchte; Stahl, chrom / Glas bedampft, schwarz-transparent

luminaire en suspension; acier, chrome / verre vaporisé, noir transparent

H 1500, Ø 540



E27



5x 40W



9 002759 986179

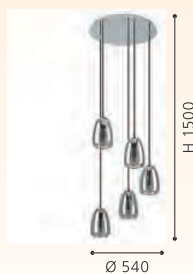

98617



98582 | 98585

98582



98585

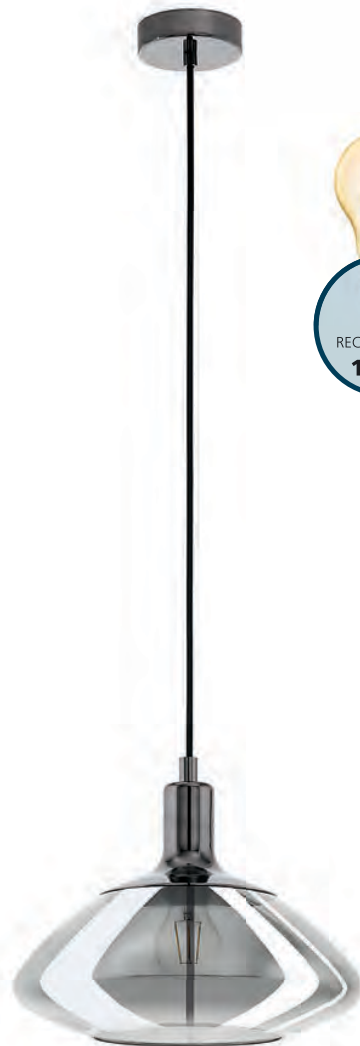

98291

98291

### 98582 CADAQUES

pendant light; steel, black / smoked glass, black-transparent  
Hängeleuchte; Stahl, schwarz / Rauchglas, schwarz-transparent  
luminaire en suspension; acier, noir / verre fumé, noir transparent

H 1100, Ø 180



E27 1x 40W



9 002759 985820



Ø 180

### 98585 CADAQUES 1

pendant light; steel, black / smoked glass, black-transparent  
Hängeleuchte; Stahl, schwarz / Rauchglas, schwarz-transparent  
luminaire en suspension; acier, noir / verre fumé, noir transparent

H 1100, Ø 160



E27 1x 40W



9 002759 985851



Ø 160

### 98291 TORRONTES

pendant light; steel, nickel-nero / smoked glass, black-transparent  
Hängeleuchte; Stahl, nickel-nero / Rauchglas, schwarz-transparent

luminaire en suspension; acier, nickel noir / verre fumé, noir transparent

H 1100, Ø 345



E27 1x 60W



9 002759 982911



Ø 345



97633

### 97633 TINDARI

pendant light; steel, nickel-nero / glass, black-transparent, white  
Hängeleuchte; Stahl, nickel-nero / Glas, schwarz-transparent,  
weiss

luminaire en suspension; acier, nickel noir / verre, noir transpa-  
rent, blanc

H 1100, Ø 250



E27 1x 60W



9 002759 976330



**97633**



98651 | 98652 | 98653 |  
98654

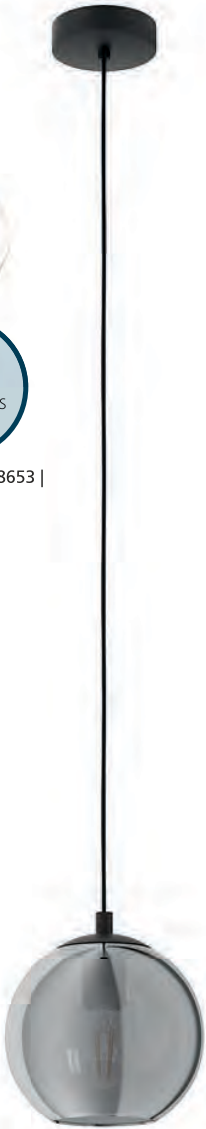

**98651**

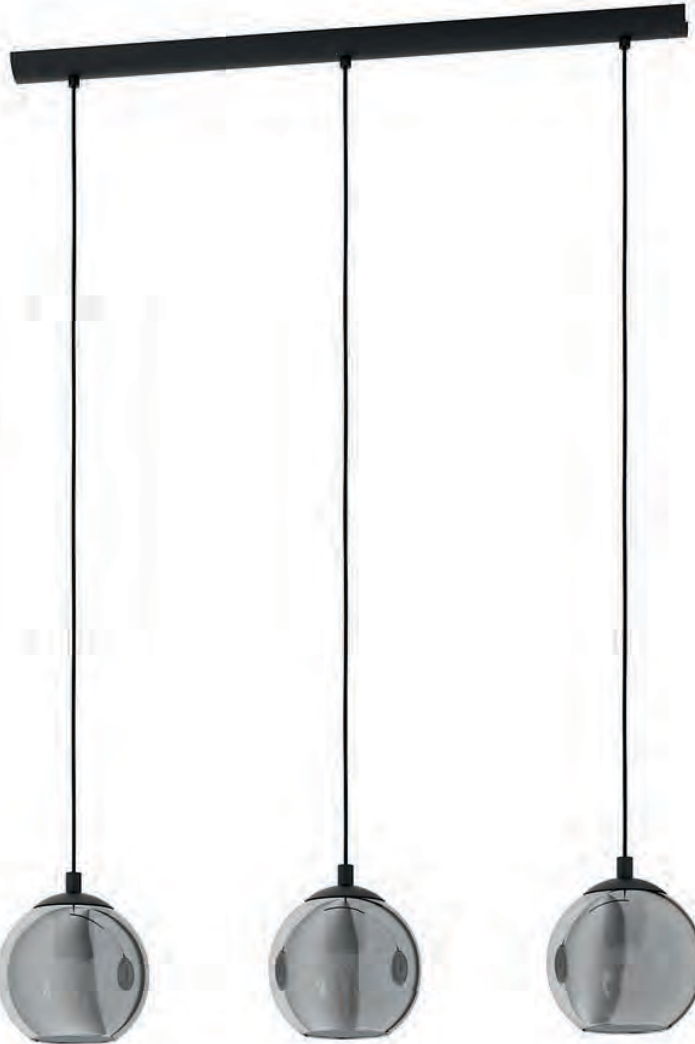

**98652**

### 98651 ARISCANI

pendant light; steel, black / glass vaporized, black-transparent  
Hängeleuchte; Stahl, schwarz / Glas bedampft, schwarz-transparent  
luminaire en suspension; acier, noir / verre vaporisé, noir transparent

H 1100, Ø 200



E27



1x 40W



9 002759 986513



### 98652 ARISCANI

pendant light; steel, black / glass vaporized, black-transparent  
Hängeleuchte; Stahl, schwarz / Glas bedampft, schwarz-transparent  
luminaire en suspension; acier, noir / verre vaporisé, noir transparent

L 765, B 165, H 1100



E27



3x 40W



9 002759 986520





98654

### 98654 ARISCANI

pendant light; steel, black / glass vaporized, black-transparent  
 Hängeleuchte; Stahl, schwarz / Glas bedampft, schwarz-transparent  
 luminaire en suspension; acier, noir / verre vaporisé, noir transparent

H 1700, Ø 655



E27 10x 40W



9 002759 986544



98653

### 98653 ARISCANI

pendant light; steel, black / glass vaporized, black-transparent  
 Hängeleuchte; Stahl, schwarz / Glas bedampft, schwarz-transparent  
 luminaire en suspension; acier, noir / verre vaporisé, noir transparent

H 1100, Ø 425



E27 3x 40W



9 002759 986537





**96774**



**96773**



96773 | 96774

### 96774 MURMILLO

pendant light; steel, chrome / smoked glass, black-transparent  
 Hängeleuchte; Stahl, chrom / Rauchglas, schwarz-transparent  
 luminaire en suspension; acier, chrome / verre fumé, noir transparent

L 770, B 170, H 1500



E27



3x 28W



9 002759 967741



### 96773 MURMILLO

pendant light; steel, chrome / smoked glass, black-transparent  
 Hängeleuchte; Stahl, chrom / Rauchglas, schwarz-transparent  
 luminaire en suspension; acier, chrome / verre fumé, noir transparent

H 1500, Ø 170



E27



1x 28W



9 002759 967734





**98694**



**98695**



**98696**



98694 | 98695

**98694 SELVINO**

pendant light; steel, satin nickel / glass vaporized, black-transparent  
 Hängeleuchte; Stahl, nickel-matt / Glas bedampft, schwarz-transparent  
 luminaire en suspension; acier, nickel mat / verre vaporisé, noir transparent  
 H 1100, Ø 100



E27 1x 15W

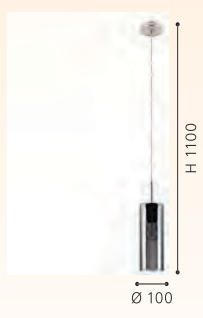

**98695 SELVINO**

pendant light; steel, satin nickel / glass vaporized, black-transparent  
 Hängeleuchte; Stahl, nickel-matt / Glas bedampft, schwarz-transparent  
 luminaire en suspension; acier, nickel mat / verre vaporisé, noir transparent  
 L 710, B 100, H 1100



E27 3x 15W



**98696 SELVINO**

pendant light; steel, satin nickel / glass vaporized, gold color  
 Hängeleuchte; Stahl, nickel-matt / Glas bedampft, goldfarben  
 luminaire en suspension; acier, nickel mat / verre vaporisé, couleurs d'or  
 H 1100, Ø 100



E27 1x 15W

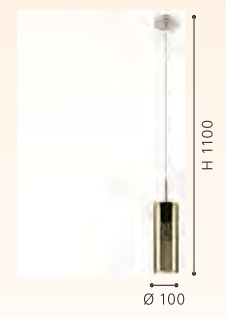



98696 | 98697 | 98698 | 98699

### 98697 SELVINO

pendant light; steel, satin nickel / glass vaporized, gold color  
 Hängeleuchte; Stahl, nickel-matt / Glas bedampft, goldfarben  
 luminaire en suspension; acier, nickel mat / verre vaporisé, couleurs d'or

L 710, B 100, H 1100



E27 3x 15W



9 002759 986971

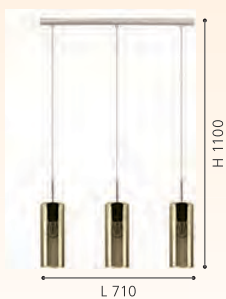

L 710

H 1100

### 98698 SELVINO

pendant light; steel, satin nickel / glass vaporized, copper-coloured  
 Hängeleuchte; Stahl, nickel-matt / Glas bedampft, kupferfarben  
 luminaire en suspension; acier, nickel mat / verre vaporisé, cuivré

H 1100, Ø 100



E27 1x 15W



9 002759 986988



Ø 100

H 1100

### 98699 SELVINO

pendant light; steel, satin nickel / glass vaporized, copper-coloured  
 Hängeleuchte; Stahl, nickel-matt / Glas bedampft, kupferfarben  
 luminaire en suspension; acier, nickel mat / verre vaporisé, cuivré

L 710, B 100, H 1100



E27 3x 15W



9 002759 986995



L 710

H 1100



98765

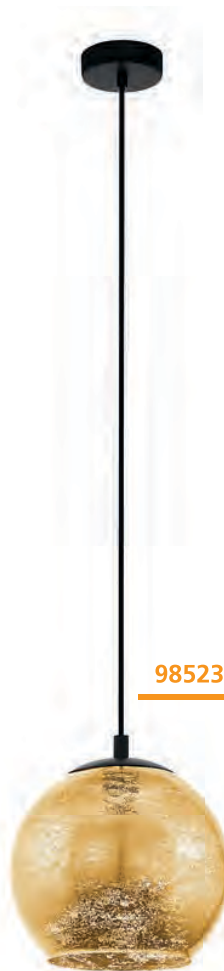

98523



98524

### 98765 ZABALEA

pendant light; steel, black / glass, bronze transparent  
 Hängeleuchte; Stahl, schwarz / Glas, bronze-transparent  
 luminaire en suspension; acier, noir / verre, bronze transparent

L 785, B 110, H 1100



E14 4x 40W



9 002759 987657



### 98523 ALBARACCIN

pendant light; steel, black / glass, gold color  
 Hängeleuchte; Stahl, schwarz / Glas, goldfarben  
 luminaire en suspension; acier, noir / verre, couleurs d'or

H 1100, Ø 270



E27 1x 40W



9 002759 985233



### 98524 ALBARACCIN

pendant light; steel, black / glass, gold color  
 Hängeleuchte; Stahl, schwarz / Glas, goldfarben  
 luminaire en suspension; acier, noir / verre, couleurs d'or

H 1100, Ø 190



E27 1x 40W



9 002759 985240





98526



98525

### 98526 ALBARACCIN

pendant light; steel, black / glass, gold color  
 Hängeleuchte; Stahl, schwarz / Glas, goldfarben  
 luminaire en suspension; acier, noir / verre, couleurs d'or

H 1500, Ø 585



E27 5x 40W

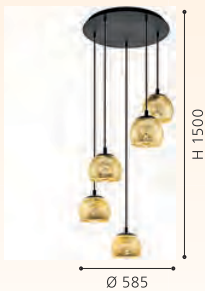

9 002759 985264

### 98525 ALBARACCIN

pendant light; steel, black / glass, gold color  
 Hängeleuchte; Stahl, schwarz / Glas, goldfarben  
 luminaire en suspension; acier, noir / verre, couleurs d'or

L 780, B 190, H 1100



E27 3x 40W



9 002759 985257





99654



99651

### 99654 LAGUNITAS

pendant light; steel, black, brass, gold / glass, clear  
 Hängeleuchte; Stahl, schwarz, messing, gold / Glas, klar  
 luminaire en suspension; acier, noir, laiton, or / verre, clair

L 910, B 150, H 1100



9 002759 996543



### 99651 LAGUNITAS

pendant light; steel, black, brass, gold / glass, clear  
 Hängeleuchte; Stahl, schwarz, messing, gold / Glas, klar  
 luminaire en suspension; acier, noir, laiton, or / verre, clair

H 1100, Ø 150



9 002759 996512





99628

LED

99629

LED

DESIGN  
HIGHLIGHT  
DETAIL

**99628 CERASELLA**

pendant light; steel, brushed brass / glass, clear  
Hängeleuchte; Stahl, messing-gebürstet / Glas, klar  
luminaire en suspension; acier, laiton brossé / verre, clair

H 1100, Ø 200

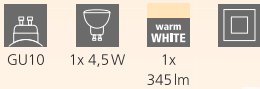

9 002759 996284



**99629 CERASELLA**

pendant light; steel, brushed brass / glass, clear  
Hängeleuchte; Stahl, messing-gebürstet / Glas, klar  
luminaire en suspension; acier, laiton brossé / verre, clair

L 900, B 200, H 1100



9 002759 996291





94589

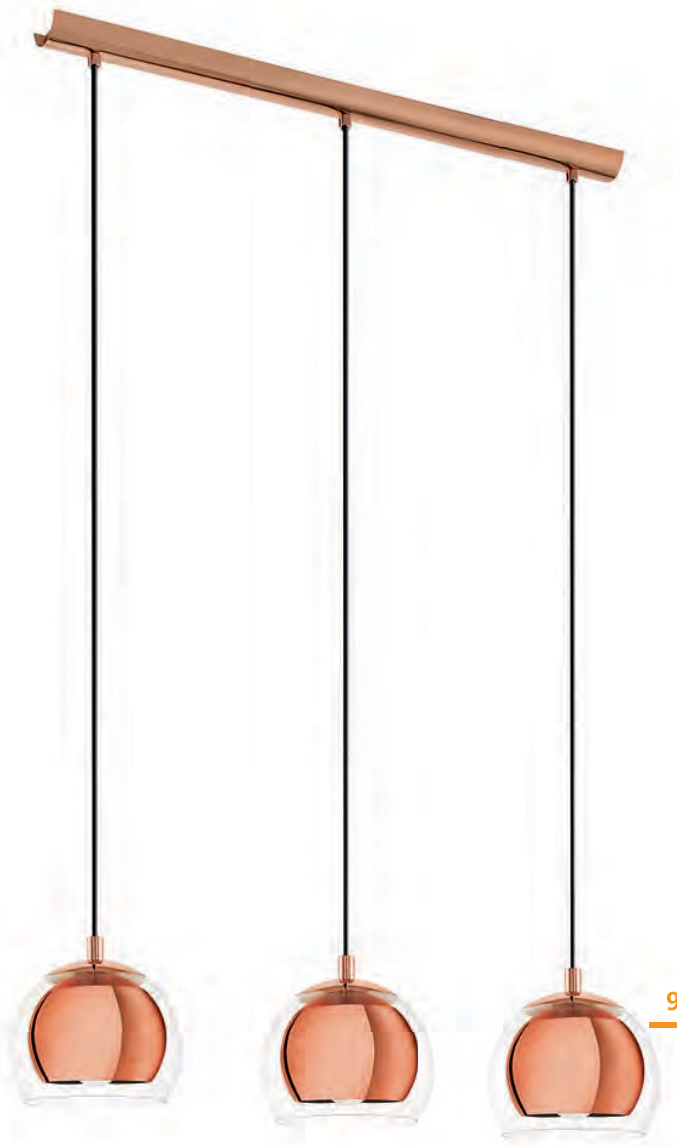

94591

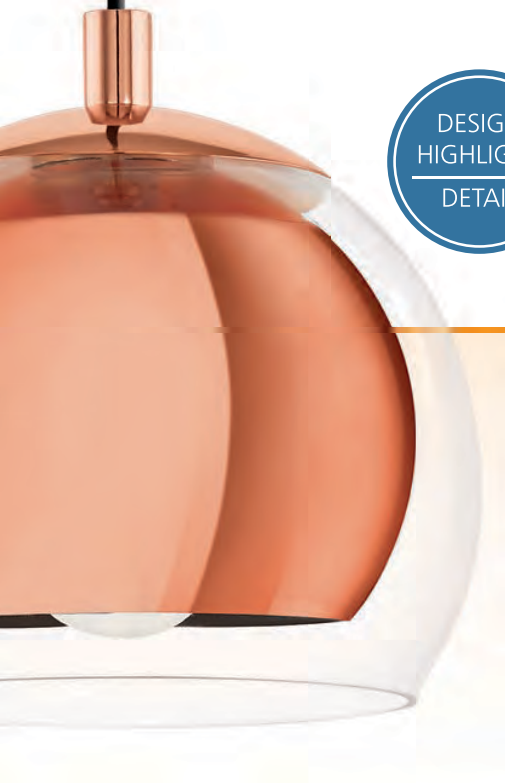

### 94589 ROCAMAR

pendant light; steel, copper / glass, clear  
Hängeleuchte; Stahl, kupfer / Glas, klar  
luminaire en suspension; acier, cuivre / verre, clair

H 1100, Ø 190



E27 1x 40W



9 002759 945893



### 94591 ROCAMAR

pendant light; steel, copper / glass, clear  
Hängeleuchte; Stahl, kupfer / Glas, klar  
luminaire en suspension; acier, cuivre / verre, clair

L 780, B 190, H 1100



E27 3x 40W



9 002759 945916

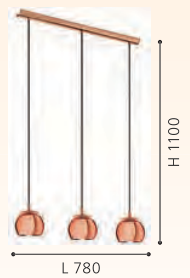





**98595**



**93836**

### 98595 ROCAMAR 1

pendant light; steel, copper / glass, clear  
Hängeleuchte; Stahl, kupfer / Glas, klar  
luminaire en suspension; acier, cuivre / verre, clair

H 1500, Ø 585



E27



5x 28W



9 002759 985950

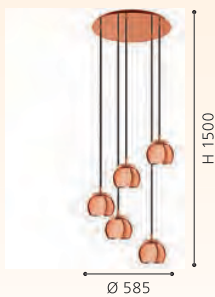

H 1500

Ø 585

### 93836 CORETTO

pendant light; steel, brushed copper  
Hängeleuchte; Stahl, kupfer-gebürstet  
luminaire en suspension; acier, cuivre brossé

H 1100, Ø 170



E27



1x 60W



9 002759 938369



H 1100

Ø 170



94592

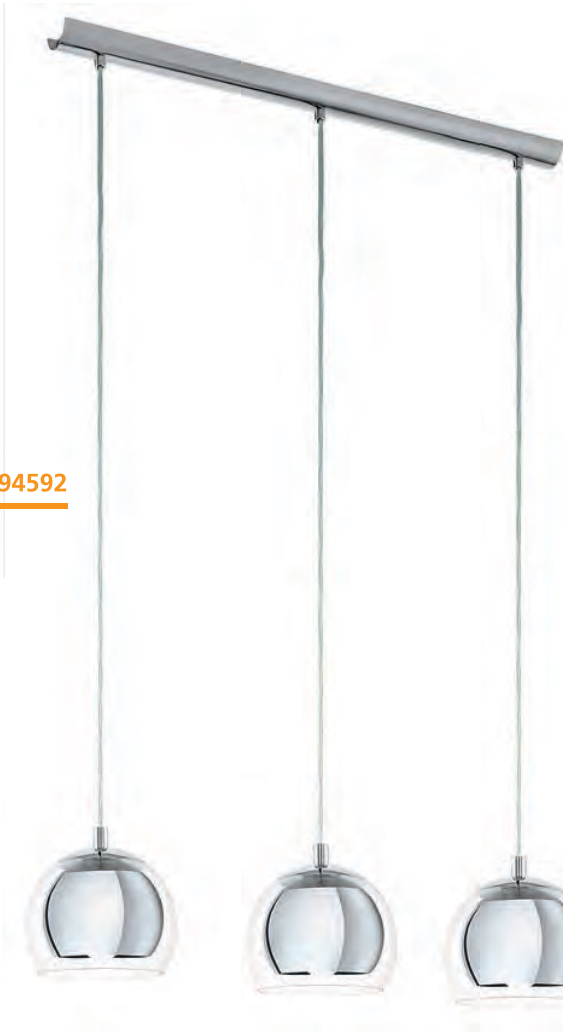

94593



98596

### 94592 ROCAMAR

pendant light; steel, chrome / glass, clear  
Hängeleuchte; Stahl, chrom / Glas, klar  
luminaire en suspension; acier, chrome / verre, clair

H 1100, Ø 190



E27 1x 40W



9 002759 945923



### 94593 ROCAMAR

pendant light; steel, chrome / glass, clear  
Hängeleuchte; Stahl, chrom / Glas, klar  
luminaire en suspension; acier, chrome / verre, clair

L 780, B 190, H 1100



E27 3x 40W



9 002759 945930



### 98596 ROCAMAR 1

pendant light; steel, chrome / glass, clear  
Hängeleuchte; Stahl, chrom / Glas, klar  
luminaire en suspension; acier, chrome / verre, clair

H 1500, Ø 585



E27 5x 28W



9 002759 985967

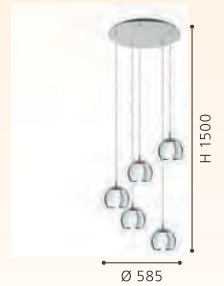



**94378**



**94377**

DESIGN  
HIGHLIGHT  
DETAIL



94377 | 94378

### 94378 LONCINO 1

pendant light; steel, chrome / glass, satin glass, clear, white  
Hängeleuchte; Stahl, chrom / Glas, Glas satiniert, klar, weiss  
luminaire en suspension; acier, chrome / verre, verre satiné, clair, blanc

L 745, B 150, H 1100



E27 3x 60W



9 002759 943783

### 94377 LONCINO 1

pendant light; steel, chrome / glass, satin glass, clear, white  
Hängeleuchte; Stahl, chrom / Glas, Glas satiniert, klar, weiss  
luminaire en suspension; acier, chrome / verre, verre satiné, clair, blanc

L 150, B 150, H 1100



E27 1x 60W



9 002759 943776



**92761**



**92762**

### 92762 BOLSANO

pendant light; steel, chrome / satin glass, glass, white, clear  
Hängeleuchte; Stahl, chrom / Glas satiniert, Glas, weiss, klar  
luminaire en suspension; acier, chrome / verre satiné, verre,  
blanc, clair

H 1300, Ø 505



E27



3x 60W



9 002759 927622



Ø 505

H 1300



## MONTEFIO 1

These luminaires come with high quality glass crystals.

Diese Leuchten sind mit hochwertigen Glaskristallen ausgestattet.

Ces luminaires viennent avec des cristaux de verre de haute qualité.



93073



93709

LED

### 93073 LUBERIO

pendant light; steel, chrome / glass, aluminium, clear, aluminium  
 Hängeleuchte; Stahl, chrom / Glas, Alu, klar, alu  
 luminaire en suspension; acier, chrome / verre, aluminium, clair, aluminium

H 1100, Ø 250



E27



1x 60W



9 002759 930738



### 93709 MONTEFIO 1

pendant light; steel, chrome / glass, crystal, white, clear  
 Hängeleuchte; Stahl, chrom / Glas, Kristall, weiss, klar  
 luminaire en suspension; acier, chrome / verre, cristal, blanc, clair

H 1100, Ø 400



3x 5W



warm  
WHITE  
3x  
480lm



9 002759 937096





93708

LED



93784

LED

### 93708 MONTEFIO 1

pendant light; steel, chrome / glass, crystal, white, clear  
Hängeleuchte; Stahl, chrom / Glas, Kristall, weiss, klar  
luminaire en suspension; acier, chrome / verre, cristal, blanc, clair

H 1100, Ø 140



LED 1x 5W  
warm WHITE 1x 480lm



9 002759 937089



### 93784 MONTEFIO 1

pendant light; steel, chrome / glass, crystal, white, clear  
Hängeleuchte; Stahl, chrom / Glas, Kristall, weiss, klar  
luminaire en suspension; acier, chrome / verre, cristal, blanc, clair

L 870, B 140, H 1100



LED 3x 5W  
warm WHITE 3x 480lm



9 002759 937843



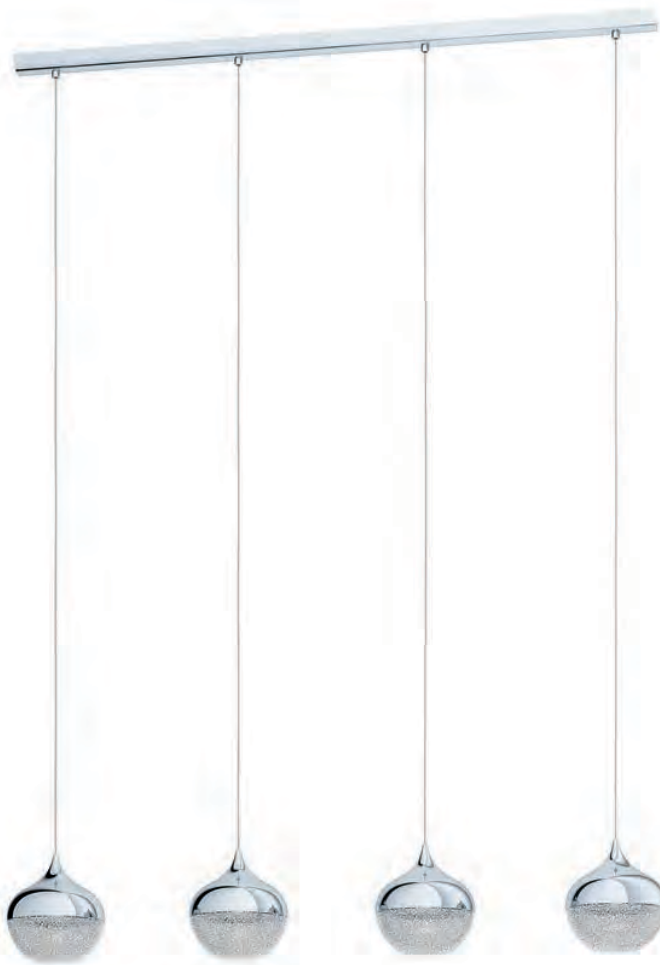

**98628**



**98629**



98628 | 98629

### 98628 MIOGLIA 1

pendant light; steel, chrome / plastic, granille white, clear  
Hängeleuchte; Stahl, chrom / Kunststoff, granille weiss, klar  
luminaire en suspension; acier, chrome / plastique, blanc granille, clair

L 975, B 150, H 1100



E14



4x 25W



9 002759 986285



### 98629 MIOGLIA 1

pendant light; steel, chrome / plastic, granille white, clear  
Hängeleuchte; Stahl, chrom / Kunststoff, granille weiss, klar  
luminaire en suspension; acier, chrome / plastique, blanc granille, clair

H 1500, Ø 540



E14



5x 25W



9 002759 986292



### 95913 CONESSA

pendant light; steel, chrome / plastic, clear  
Hängeleuchte; Stahl, chrom / Kunststoff, klar  
luminaire en suspension; acier, chrome / plastique, clair

H 1100, Ø 290



GU10



3x 3W



warm WHITE

3x 250lm



9 002759 959135





95912

LED

95913

LED



95914

LED

### 95912 CONESSA

pendant light; steel, chrome / plastic, clear  
Hängeleuchte; Stahl, chrom / Kunststoff, klar  
luminaire en suspension; acier, chrome / plastique, clair

L 1010, B 150, H 1100



GU10



4x 3W



warm  
WHITE

4x

250lm

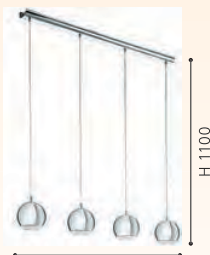

L 1010

H 1100

### 95914 CONESSA

pendant light; steel, chrome / plastic, clear  
Hängeleuchte; Stahl, chrom / Kunststoff, klar  
luminaire en suspension; acier, chrome / plastique, clair

H 1700, Ø 580



GU10



10x 3W



warm  
WHITE

10x

250lm

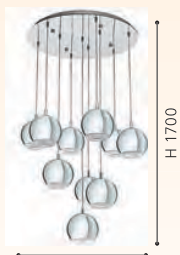

Ø 580

H 1700



9 002759 959128



9 002759 959142







### 98346 BOCADELLA

pendant light; steel, black  
 Hängeleuchte; Stahl, schwarz  
 luminaire en suspension; acier, noir

H 1100, Ø 640



E27 9x 60W



9 002759 983468



Ø 640

### 98347 BOCADELLA

pendant light; steel, black  
 Hängeleuchte; Stahl, schwarz  
 luminaire en suspension; acier, noir

H 1100, Ø 920



E27 12x 60W



9 002759 983475



Ø 920

### 98909 MEZZANA

pendant light; steel, black  
 Hängeleuchte; Stahl, schwarz  
 luminaire en suspension; acier, noir

L 650, B 650, H 1100



E27 8x 40W



9 002759 989095

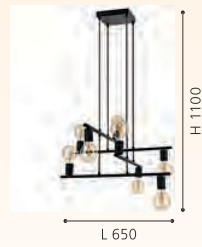

L 650



98909



98017

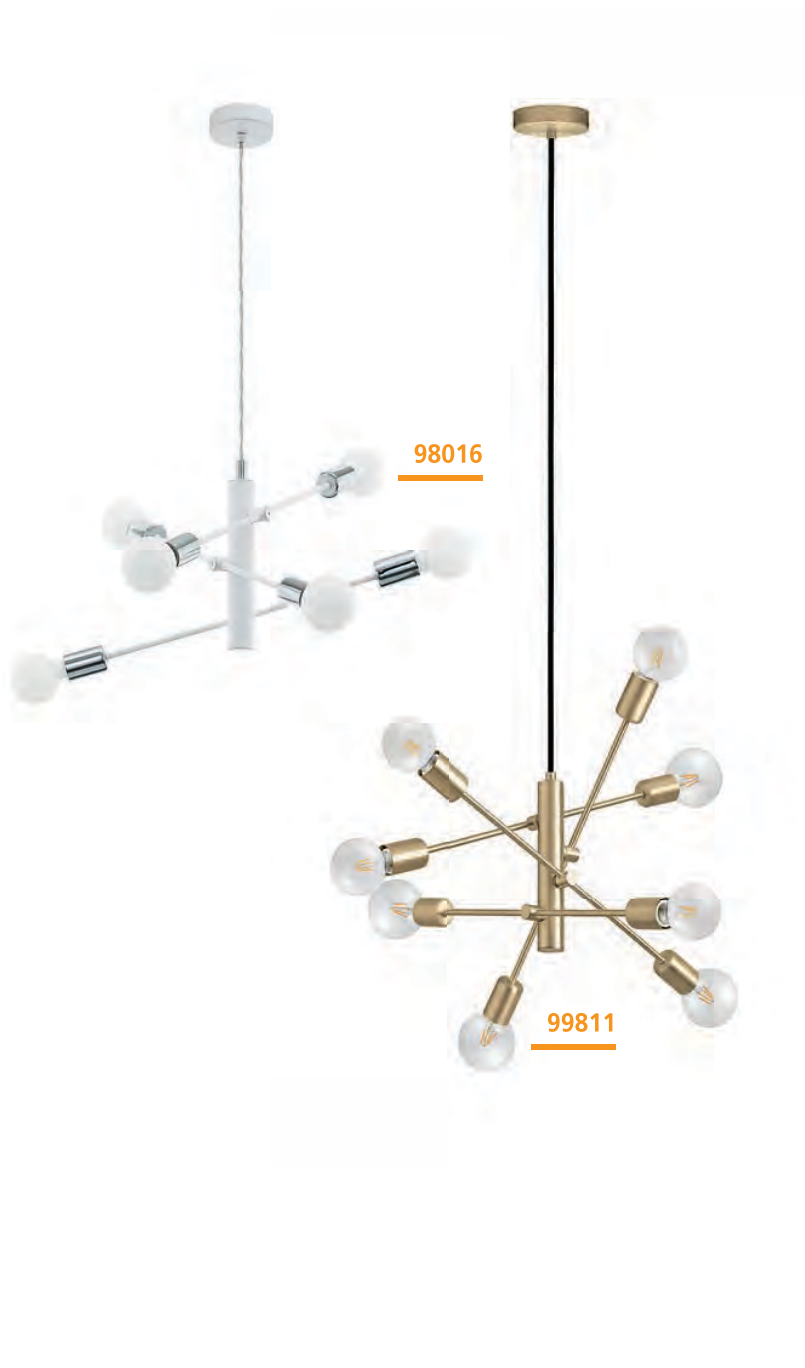

98016

99811

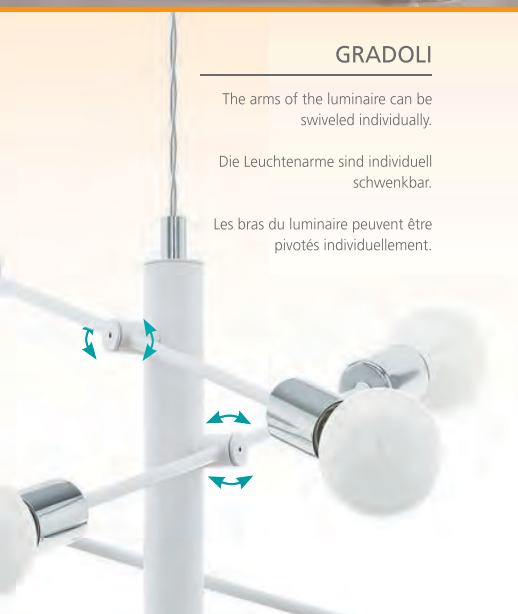

## GRADOLI

The arms of the luminaire can be swiveled individually.

Die Leuchtenarme sind individuell schwenkbar.

Les bras du luminaire peuvent être pivotés individuellement.

### 98017 GRADOLI

pendant light; steel, white, chrome  
Hängeleuchte; Stahl, weiss, chrom  
luminaire en suspension; acier, blanc, chrome

H 1100, Ø 710



E27 8x 60W



9 002759 980177



H 1100

Ø 710

### 98016 GRADOLI

pendant light; steel, white, chrome  
Hängeleuchte; Stahl, weiss, chrom  
luminaire en suspension; acier, blanc, chrome

H 1100, Ø 550



E27 6x 60W



9 002759 980160



H 1100

Ø 550



98835



98834 | 98835



98834



### 99811 GRADOLI 1

pendant light; steel, brushed brass  
Hängeleuchte; Stahl, messing-gebürstet  
luminaire en suspension; acier, laiton brossé

H 1100, Ø 710



E27 8x 40W



### 98835 MANIZALES

pendant light; steel, brushed brass  
Hängeleuchte; Stahl, messing-gebürstet  
luminaire en suspension; acier, laiton brossé

L 1010, B 50, H 1100



E27 3x 40W



### 98834 MANIZALES

pendant light; steel, brushed brass  
Hängeleuchte; Stahl, messing-gebürstet  
luminaire en suspension; acier, laiton brossé

L 250, B 105, H 1100



E27 1x 40W

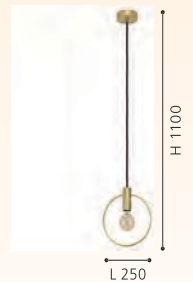



### 97734 MONTEBALDO

pendant light; steel, black, gold  
 Hängeleuchte; Stahl, schwarz, gold  
 luminaire en suspension; acier, noir, or

L 850, B 100, H 1100



### 97733 MONTEBALDO

pendant light; steel, black, gold  
 Hängeleuchte; Stahl, schwarz, gold  
 luminaire en suspension; acier, noir, or

L 100, B 100, H 1100

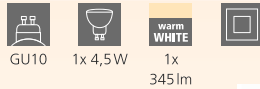

### 98858 BITACHITO

pendant light; steel, black, brass  
 Hängeleuchte; Stahl, schwarz, messing  
 luminaire en suspension; acier, noir, laiton

L 930, B 55, H 1100



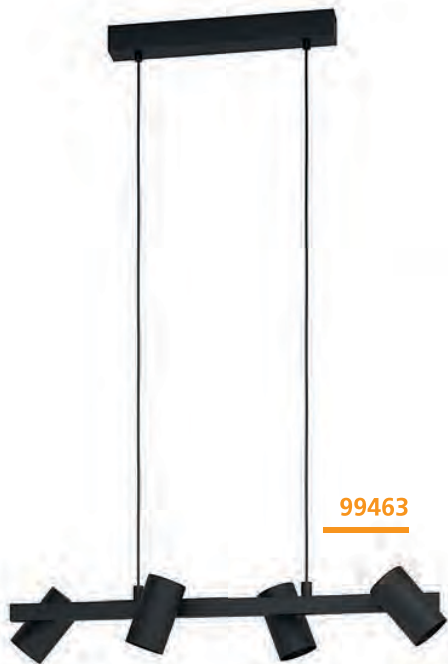

99463



99464



98686

### 99463 GATUELA 1

pendant light; steel, black  
Hängeleuchte; Stahl, schwarz  
luminaire en suspension; acier, noir

L 760, B 190, H 1100



E14



4x 25W



9 002759 994631



### 99464 GATUELA 1

pendant light; steel, black  
Hängeleuchte; Stahl, schwarz  
luminaire en suspension; acier, noir

L 1160, B 190, H 1100



E14



6x 25W



9 002759 994648



### 98686 GATUELA

pendant light; steel, white, satin nickel  
Hängeleuchte; Stahl, weiss, nickel-matt  
luminaire en suspension; acier, blanc, nickel mat

L 760, B 190, H 1100



E14



4x 25W



9 002759 986865

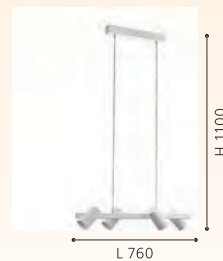



### 98687 GATUELA

pendant light; steel, white, satin nickel  
 Hängeleuchte; Stahl, weiss, nickel-matt  
 luminaire en suspension; acier, blanc, nickel mat

L 1160, B 190, H 1100



E14 6x 25W



9 002759 986872



L 1160



9 002759 998196

### 99819 ROVIRA

pendant light; aluminium, steel, silver / plastic, white  
 Hängeleuchte; Alu, Stahl, silber / Kunststoff, weiss  
 luminaire en suspension; aluminium, acier, argent / plastique, blanc

L 770, B 50, H 1100



LED warm WHITE 3x 6,5W 2280lm

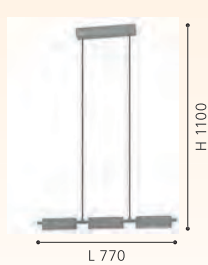

L 770

### 99821 ROVIRA

pendant light; aluminium, steel, black / plastic, white  
 Hängeleuchte; Alu, Stahl, schwarz / Kunststoff, weiss  
 luminaire en suspension; aluminium, acier, noir / plastique, blanc

L 770, B 50, H 1100



LED warm WHITE 3x 6,5W 2280lm



9 002759 998219

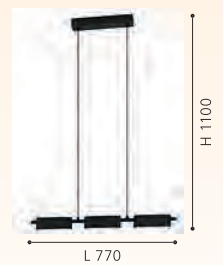

L 770



### 98681 PERPIGO

pendant light; steel, black / plastic, white  
 Hängeleuchte; Stahl, schwarz / Kunststoff, weiss  
 luminaire en suspension; acier, noir / plastique, blanc

H 1100, Ø 165

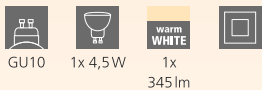

GU10 1x 4,5W 1x 345lm



9 002759 986810



### 98682 PERPIGO

pendant light; steel, black / plastic, white  
 Hängeleuchte; Stahl, schwarz / Kunststoff, weiss  
 luminaire en suspension; acier, noir / plastique, blanc

L 865, B 165, H 1100



GU10 3x 4,5W 3x 345lm



9 002759 986827

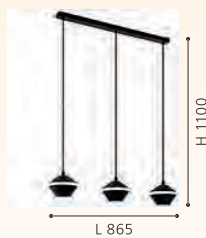

### 98683 PERPIGO

pendant light; steel, black / plastic, white  
 Hängeleuchte; Stahl, schwarz / Kunststoff, weiss  
 luminaire en suspension; acier, noir / plastique, blanc

H 1500, Ø 555



GU10 5x 4,5W 5x 345lm



9 002759 986834

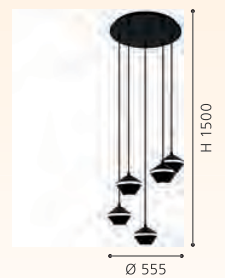





99081



99082



99083



99081 | 99082 | 99083

### 99081 VALECROSIA

pendant light; steel, black, white  
Hängeleuchte; Stahl, schwarz, weiss  
luminaire en suspension; acier, noir, blanc

H 1100, Ø 420



9 002759 990817



### 99082 VALECROSIA

pendant light; steel, black, white  
Hängeleuchte; Stahl, schwarz, weiss  
luminaire en suspension; acier, noir, blanc

L 180, B 180, H 1100



9 002759 990824



### 99083 VALECROSIA

pendant light; steel, black, white  
Hängeleuchte; Stahl, schwarz, weiss  
luminaire en suspension; acier, noir, blanc

L 840, B 180, H 1100



9 002759 990831





**98688 OKINZURI**

pendant light; steel, nickel-nero  
 Hängeleuchte; Stahl, nickel-nero  
 luminaire en suspension; acier, nickel noir

H 1100, Ø 450



E27 1x 60W



9 002759 986889

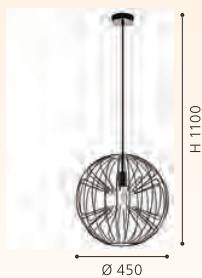

**98689 OKINZURI**

pendant light; steel, brass  
 Hängeleuchte; Stahl, messing  
 luminaire en suspension; acier, laiton

H 1100, Ø 450



E27 1x 60W



9 002759 986896



**97066 ESTEVAU**

pendant light; steel, dark brown  
 Hängeleuchte; Stahl, dunkelbraun  
 luminaire en suspension; acier, marron foncé

L 975, B 145, H 1100



E27 4x 60W



9 002759 970666





92251



92252



92251 | 92252 | 94388 |  
94389

### 92251 RAZONI

pendant light; steel, white / satin glass, steel, white  
Hängeleuchte; Stahl, weiss / Glas satiniert, Stahl, weiss  
luminaire en suspension; acier, blanc / verre satiné, acier, blanc

H 1300, Ø 190



E27



1x 60W





94388



94389

### 92252 RAZONI

pendant light; steel, black / satin glass, steel, black, white  
 Hängeleuchte; Stahl, schwarz / Glas satiniert, Stahl, schwarz, weiss  
 luminaire en suspension; acier, noir / verre satiné, acier, noir, blanc

H 1300, Ø 190



E27 1x 60W



9 002759 922528



### 94388 RAZONI

pendant light; steel, white / satin glass, steel, white  
 Hängeleuchte; Stahl, weiss / Glas satiniert, Stahl, weiss  
 luminaire en suspension; acier, blanc / verre satiné, acier, blanc

L 990, B 190, H 1100



E27 3x 60W



9 002759 943882



### 94389 RAZONI

pendant light; steel, black / satin glass, steel, black, white  
 Hängeleuchte; Stahl, schwarz / Glas satiniert, Stahl, schwarz, weiss  
 luminaire en suspension; acier, noir / verre satiné, acier, noir, blanc

L 990, B 190, H 1100



E27 3x 60W



9 002759 943899





99635 | 99636



99634



99636

### 99634 MASETA

pendant light; steel, black / smoked glass, black-transparent  
Hängeleuchte; Stahl, schwarz / Rauchglas, schwarz-transparent  
luminaire en suspension; acier, noir / verre fumé, noir transparent

L 930, B 225, H 1100



E27 3x 40W



### 99636 MASETA

pendant light; steel, gold-coloured / glass opal-matt, white  
Hängeleuchte; Stahl, goldfarben / Glas opal-matt, weiss  
luminaire en suspension; acier, doré / verre opale mat, blanc

L 930, B 225, H 1100



E27 3x 40W



### 99633 MASETA

pendant light; steel, black / smoked glass, black-transparent  
Hängeleuchte; Stahl, schwarz / Rauchglas, schwarz-transparent  
luminaire en suspension; acier, noir / verre fumé, noir transparent

H 1100, Ø 225



E27 1x 40W

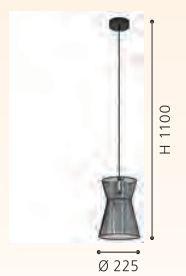



99633



99633 | 99634

### 99635 MASETA

pendant light; steel, gold-coloured / glass opal-matt, white  
Hängeleuchte; Stahl, goldfarben / Glas opal-matt, weiss  
luminaire en suspension; acier, doré / verre opale mat, blanc

H 1100, Ø 225



E27



1x 40W



9 002759 996352

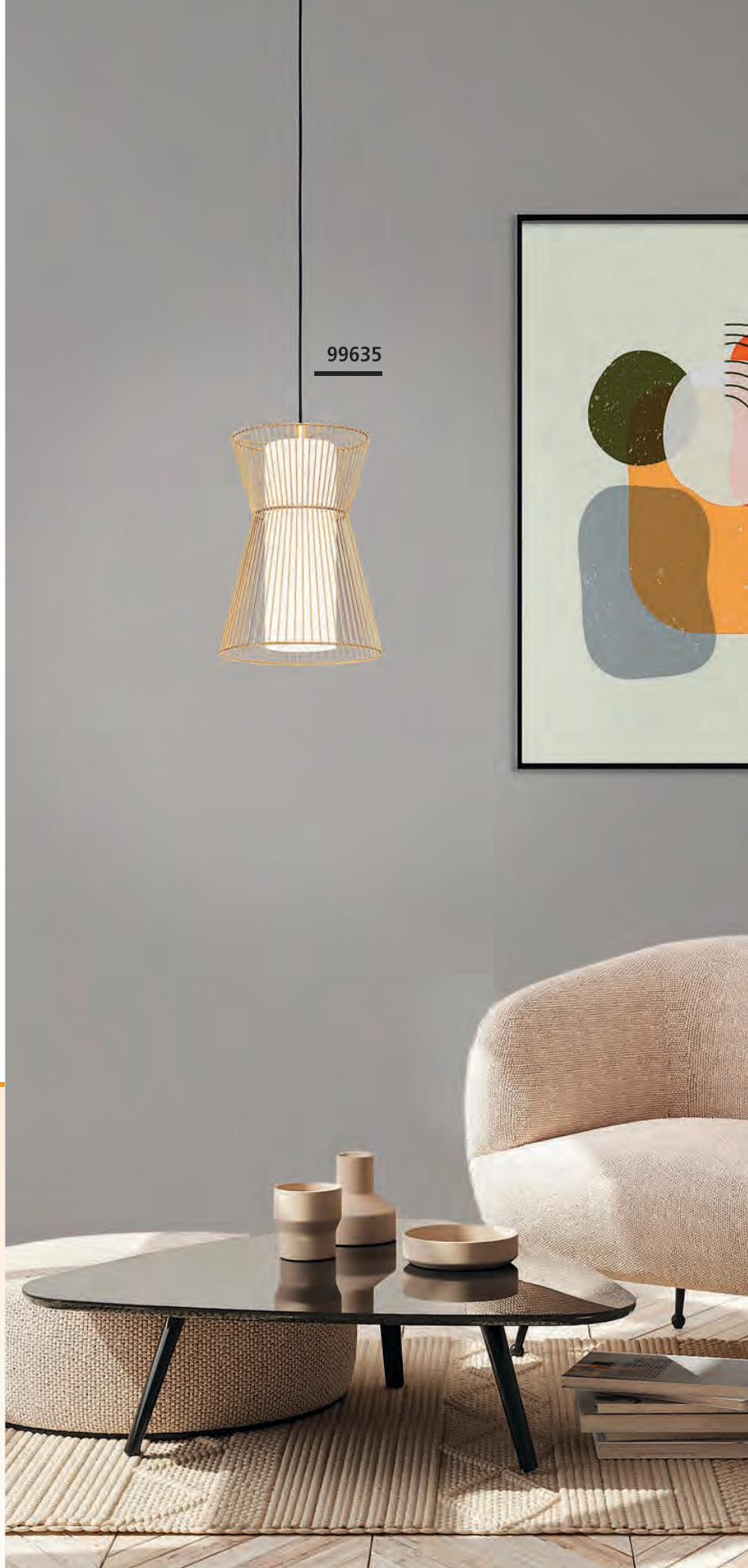

99635



### 99705 FLORESTA

pendant light; steel, black / glass vaporized, black-transparent  
 Hängeleuchte; Stahl, schwarz / Glas bedampft, schwarz-transparent  
 luminaire en suspension; acier, noir / verre vaporisé, noir transparent

H 1100, Ø 195



E27 1x 40W



9 002759 997052



### 99706 FLORESTA

pendant light; steel, black / glass vaporized, black-transparent  
 Hängeleuchte; Stahl, schwarz / Glas bedampft, schwarz-transparent  
 luminaire en suspension; acier, noir / verre vaporisé, noir transparent

L 890, B 190, H 1100



E27 3x 40W



9 002759 997069



### 99707 ZOCABON

pendant light; steel, black / glass, clear  
 Hängeleuchte; Stahl, schwarz / Glas, klar  
 luminaire en suspension; acier, noir / verre, clair

L 815, B 110, H 1100



E27 4x 40W



9 002759 997076





99665

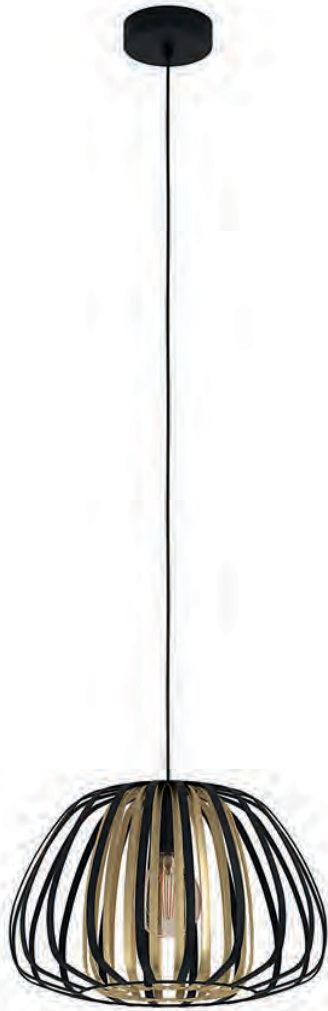

99666

DESIGN  
HIGHLIGHT  
DETAIL

### 99665 ENCINITOS

pendant light; steel, black, gold  
Hängeleuchte; Stahl, schwarz, gold  
luminaire en suspension; acier, noir, or

H 1100, Ø 255



9 002759 996659



### 99666 ENCINITOS

pendant light; steel, black, gold  
Hängeleuchte; Stahl, schwarz, gold  
luminaire en suspension; acier, noir, or

H 1100, Ø 375



9 002759 996666







99694

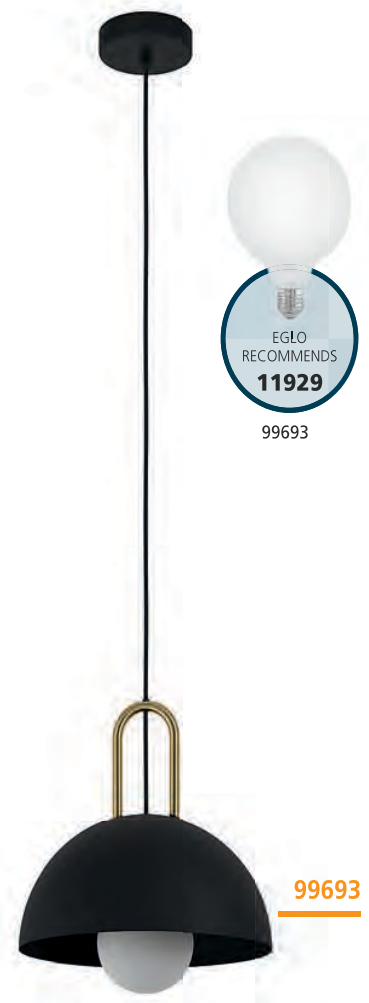

99693

99693

### 99694 CALMANERA

pendant light; steel, black, brass  
 Hängeleuchte; Stahl, schwarz, messing  
 luminaire en suspension; acier, noir, laiton

L 900, B 200, H 1100



E27 3x 40W



9 002759 996949



### 99693 CALMANERA

pendant light; steel, black, brass  
 Hängeleuchte; Stahl, schwarz, messing  
 luminaire en suspension; acier, noir, laiton

H 1100, Ø 325



E27 1x 40W



9 002759 996932





99695 | 99696

99696



99695

### 99696 CALMANERA

pendant light; steel, white, brass  
Hängeleuchte; Stahl, weiss, messing  
luminaire en suspension; acier, blanc, laiton

L 900, B 200, H 1100



E27



3x 40W



9 002759 996963



### 99695 CALMANERA

pendant light; steel, white, brass  
Hängeleuchte; Stahl, weiss, messing  
luminaire en suspension; acier, blanc, laiton

H 1100, Ø 325



E27



1x 40W



9 002759 996956





99439

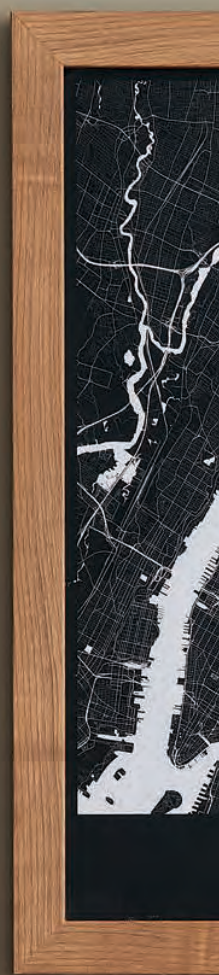



### 99439 SEGEZIA

pendant light; steel, Mokka colour / steel, Mokka colour, gold  
 Hängeleuchte; Stahl, Mokkafarben / Stahl, Mokka, gold  
 luminaire en suspension; acier, mocha couleur / acier, Mokka, or

H 1100, Ø 350



E27 1x 40W



9 002759 994396



### 99438 SEGEZIA

pendant light; steel, Mokka colour / steel, Mokka colour, gold  
 Hängeleuchte; Stahl, Mokkafarben / Stahl, Mokka, gold  
 luminaire en suspension; acier, mocha couleur / acier, Mokka, or

L 880, B 180, H 1100



E27 3x 40W



9 002759 994389



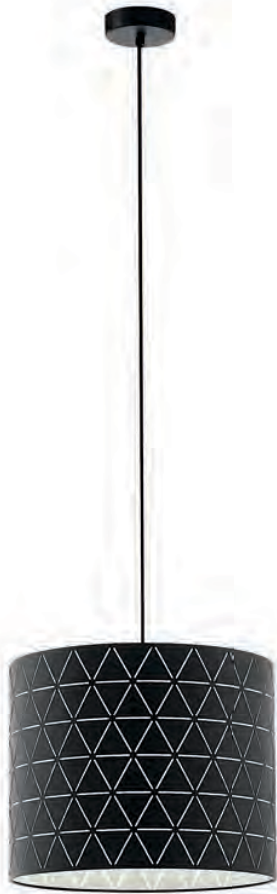

98351



98352



98353

### 98351 RAMON

pendant light; steel, black / film, white  
Hängeleuchte; Stahl, schwarz / Folie, weiss  
luminaire en suspension; acier, noir / film, blanc

H 1100, Ø 370



E27 1x 40W



9 002759 983512

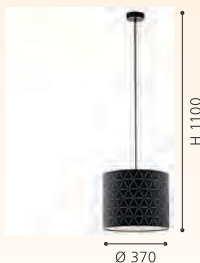

### 98352 RAMON

pendant light; steel, black / film, white  
Hängeleuchte; Stahl, schwarz / Folie, weiss  
luminaire en suspension; acier, noir / film, blanc

H 1100, Ø 160



E27 1x 40W



9 002759 983529



### 98353 RAMON

pendant light; steel, black / film, white  
Hängeleuchte; Stahl, schwarz / Folie, weiss  
luminaire en suspension; acier, noir / film, blanc

L 860, B 160, H 1100



E27 3x 40W



9 002759 983536





98456

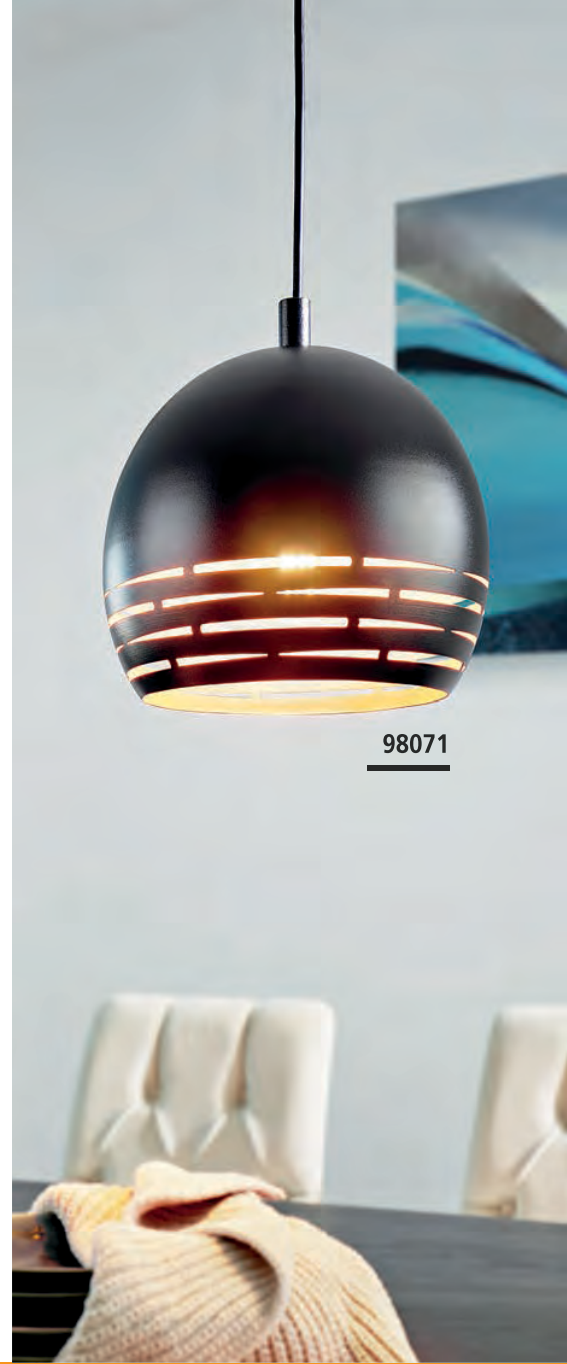

98071

### 98456 CANTALLOPS

pendant light; steel, black  
Hängeleuchte; Stahl, schwarz  
luminaire en suspension; acier, noir

L 1150, B 520, H 1100



E14 6x 40W



H 1100

L 1150



9 002759 984564

### 98071 CAMASTRA

pendant light; steel, black, gold  
Hängeleuchte; Stahl, schwarz, gold  
luminaire en suspension; acier, noir, or

H 1100, Ø 225



E27 1x 40W



H 1100

Ø 225



9 002759 980719



33345



97845



97841

### 33345 ROCCAFORTE

pendant light; steel, black, gold  
Hängeleuchte; Stahl, schwarz, gold  
luminaire en suspension; acier, noir, or

H 1100, Ø 170



E14 1x 40W



9 002759 333454



### 97845 ROCCAFORTE

pendant light; steel, black, gold  
Hängeleuchte; Stahl, schwarz, gold  
luminaire en suspension; acier, noir, or

H 1100, Ø 300



E27 1x 60W



9 002759 978457



### 97841 ROCCAFORTE

pendant light; steel, black, gold  
Hängeleuchte; Stahl, schwarz, gold  
luminaire en suspension; acier, noir, or

H 1100, Ø 400



E27 1x 60W



9 002759 978419





97846

### 97846 ROCCAFORTE

pendant light; steel, black, gold  
Hängeleuchte; Stahl, schwarz, gold  
luminaire en suspension; acier, noir, or

L 750, B 170, H 1100



E14



3x 40W



DESIGN  
HIGHLIGHT  
DETAIL

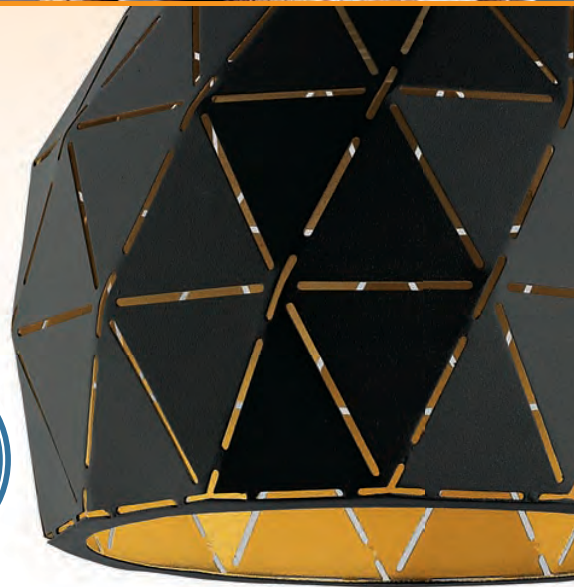





95385



95383



95384

### 95385 OBREGON

pendant light; steel, brown, creme, oak  
Hängeleuchte; Stahl, braun, creme, eiche  
luminaire en suspension; acier, marron, crème, chêne

H 1100, Ø 350



E27 1x 60W



9 002759 953850



### 95383 OBREGON

pendant light; steel, creme, oak  
Hängeleuchte; Stahl, creme, eiche  
luminaire en suspension; acier, crème, chêne

H 1100, Ø 350



E27 1x 60W



9 002759 953836



### 95384 OBREGON

pendant light; steel, white, chrome  
Hängeleuchte; Stahl, weiss, chrom  
luminaire en suspension; acier, blanc, chrome

H 1100, Ø 350



E27 1x 60W



9 002759 953843





96981



96982



96983

### 96981 SABINAR

pendant light; steel, white / wood, brown  
Hängeleuchte; Stahl, weiss / Holz, braun  
luminaire en suspension; acier, blanc / bois, marron

H 1100, Ø 180



E27 1x 60W



9 002759 969813



Ø 180

### 96982 SABINAR

pendant light; steel, white / wood, brown  
Hängeleuchte; Stahl, weiss / Holz, braun  
luminaire en suspension; acier, blanc / bois, marron

H 1100, Ø 280



E27 1x 60W



9 002759 969820



Ø 280

### 96983 SABINAR

pendant light; steel, white / wood, brown  
Hängeleuchte; Stahl, weiss / Holz, braun  
luminaire en suspension; acier, blanc / bois, marron

H 1100, Ø 400



E27 1x 60W



9 002759 969837



Ø 400



96985



96986



### 96985 SABINAR

pendant light; steel, brushed silver / wood, brown  
Hängeleuchte; Stahl, silber gebürstet / Holz, braun  
luminaire en suspension; acier, argent brossé / bois, marron

H 1100, Ø 280



E27 1x 60 W



### 96986 SABINAR

pendant light; steel, brushed silver / wood, brown  
Hängeleuchte; Stahl, silber gebürstet / Holz, braun  
luminaire en suspension; acier, argent brossé / bois, marron

H 1100, Ø 400



E27 1x 60 W





95755



94935



94936

### 95755 NUVANO

pendant light; steel, brown, gold  
Hängeleuchte; Stahl, braun, gold  
luminaire en suspension; acier, marron, or

H 1100, Ø 480



E27 1x 60W



9 002759 957551



### 94935 GAETANO 1

pendant light; steel, black, gold  
Hängeleuchte; Stahl, schwarz, gold  
luminaire en suspension; acier, noir, or

H 1500, Ø 380



E27 1x 60W



9 002759 949358



### 94936 GAETANO 1

pendant light; steel, black, gold  
Hängeleuchte; Stahl, schwarz, gold  
luminaire en suspension; acier, noir, or

H 1500, Ø 530



E27 1x 60W



9 002759 949365





99663

LED

### 99663 NUVANO

pendant light; steel, black, gold  
 Hängeleuchte; Stahl, schwarz, gold  
 luminaire en suspension; acier, noir, or

L 985, B 225, H 1100



GU10



3x 4,5W



3x  
 345lm





94938

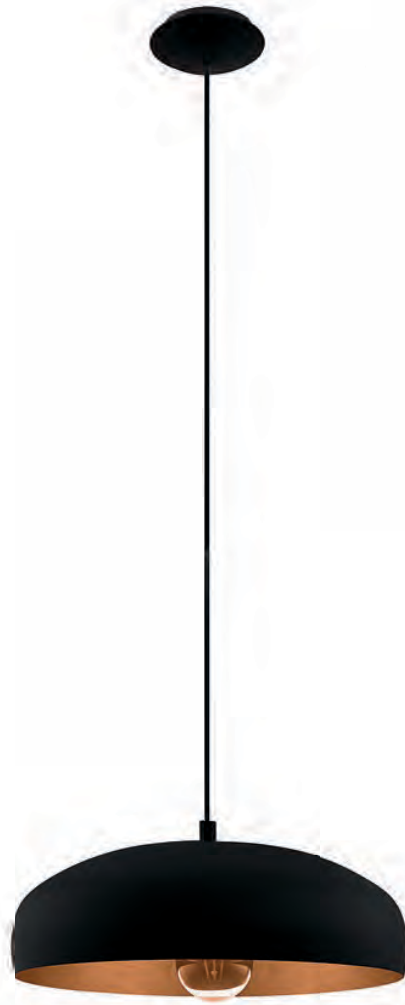

94605



94606

### 94938 GAETANO 1

pendant light; steel, black, copper  
Hängeleuchte; Stahl, schwarz, kupfer  
luminaire en suspension; acier, noir, cuivre

H 1500, Ø 530



E27 1x 60W



9 002759 949389



Ø 530

### 94605 MOGANO 1

pendant light; steel, black, copper  
Hängeleuchte; Stahl, schwarz, kupfer  
luminaire en suspension; acier, noir, cuivre

H 1100, Ø 400



E27 1x 60W



9 002759 946050



Ø 400

### 94606 MOGANO 1

pendant light; steel, white, copper  
Hängeleuchte; Stahl, weiss, kupfer  
luminaire en suspension; acier, blanc, cuivre

H 1100, Ø 400



E27 1x 60W



9 002759 946067



Ø 400



87055



31666

### 87055 BRENDA

pendant light; plastic, steel, white, chrome / steel, white  
 Hängeleuchte; Kunststoff, Stahl, weiss, chrom / Stahl, weiss  
 luminaire en suspension; plastique, acier, blanc, chrome / acier, blanc

H 1300, Ø 430



E27 1x 60W



9 002759 870553

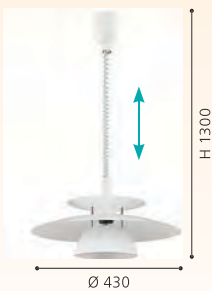

H 1300

Ø 430

### 31666 BRENDA

pendant light; plastic, steel, black / steel, black, copper  
 Hängeleuchte; Kunststoff, Stahl, schwarz / Stahl, schwarz, kupfer  
 luminaire en suspension; plastique, acier, noir / acier, noir, cuivre

H 1100, Ø 430



E27 1x 60W



9 002759 316662

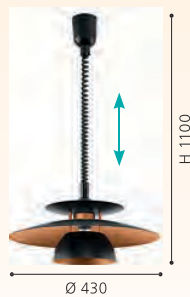

H 1100

Ø 430

### BRENDA

This luminaires are flexible in height thanks to the spiral cables.

Diese Leuchten sind durch die Spiralkabel in der Höhe verstellbar.

La hauteur de ces lumières peut être ajustée à l'aide du câble en spirale.





**99452**



**94353**



**94354**

### 99452 GAETANO 1

pendant light; steel, black, grey  
Hängeleuchte; Stahl, schwarz, grau  
luminaire en suspension; acier, noir, gris

H 1100, Ø 530



E27 1x 40W



9 002759 994525



Ø 530

H 1100

### 94353 SARABIA

pendant light; steel, grey  
Hängeleuchte; Stahl, grau  
luminaire en suspension; acier, gris

H 1100, Ø 275



E27 1x 60W



9 002759 943530



Ø 275

H 1100

### 94354 SARABIA

pendant light; steel, grey  
Hängeleuchte; Stahl, grau  
luminaire en suspension; acier, gris

H 2000, Ø 405



E27 1x 60W



9 002759 943547



Ø 405

H 2000



# WALL & CEILING LUMINAIRES

WAND- & DECKENLEUCHTEN  
APPLIQUES & PLAFONNIERS

## OUR ALL-ROUNDERS -

The range of wall and ceiling luminaires goes from simple to unusual designs. No matter if for the entrance area, hallway or your living rooms – these luminaires give the right light.

## UNSERE ALLROUNDER -

Das Sortiment an Wand- und Deckenleuchten reicht von schlichten bis hin zu ausgefallenen Designs. Egal ob für Eingangsbereich, Flur oder Ihre Wohnräume - diese Leuchten spenden das passende Licht.



## NOS PASSE-PARTOUT -

La gamme d'éclairages muraux et de plafonds s'étend de designs simples à extraordinaires. Que ce soit pour l'entrée, le couloir ou vos espaces d'habitat - ces luminaires apportent la lumière appropriée.



Travel makes  
you realize that  
no matter how  
much you know,  
there's always



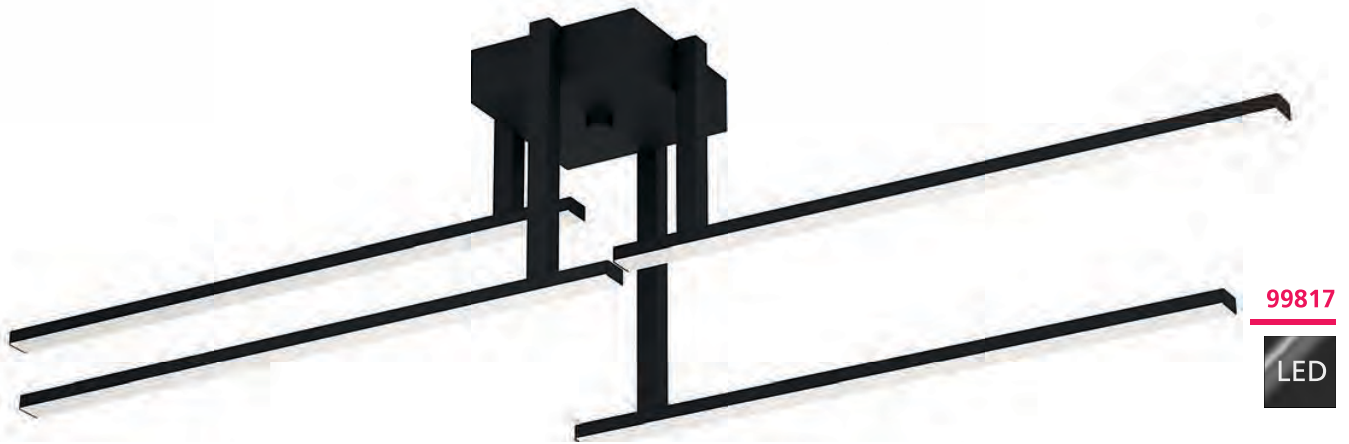

99817

LED



99395

LED

### 99817 IPOLITTO

ceiling light; aluminium, steel, black / plastic, white  
Deckenleuchte; Alu, Stahl, schwarz / Kunststoff, weiss  
plafonnier; aluminium, acier, noir / plastique, blanc

L 780, B 165, H 235



32 W 3840 lm

### 99395 ROLIMARE

ceiling light; aluminium, black / plastic, white  
Deckenleuchte; Alu, schwarz / Kunststoff, weiss  
plafonnier; aluminium, noir / plastique, blanc

L 420, B 400, H 130



35 W 5500 lm

### 98539 GROMOLA

ceiling light; aluminium, steel, black, champagne  
Deckenleuchte; Alu, Stahl, schwarz, champagner  
plafonnier; aluminium, acier, noir, champagne

H 330, Ø 540



33,8 W 4000 lm



9 002759 998172

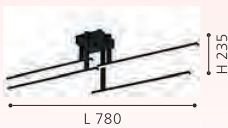

L 780

H 235



9 002759 993955



L 420

H 130



9 002759 985394



Ø 540

H 330



98861



98861 | 98862 | 98863



98862



### 98861 MIRLAS

ceiling light; wood, steel, brown / plastic, white  
Deckenleuchte; Holz, Stahl, braun / Kunststoff, weiss  
plafonnier; bois, acier, marron / plastique, blanc

L 360, B 210, H 90



E27



2x 9W



9 002759 988616

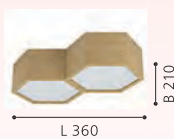

### 98862 MIRLAS

ceiling light; wood, steel, brown / plastic, white  
Deckenleuchte; Holz, Stahl, braun / Kunststoff, weiss  
plafonnier; bois, acier, marron / plastique, blanc

L 540, B 520, H 90



E27



4x 9W



9 002759 988623

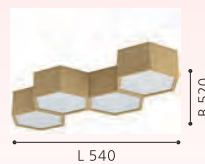

### 98863 MIRLAS

ceiling light; wood, steel, brown / plastic, white  
Deckenleuchte; Holz, Stahl, braun / Kunststoff, weiss  
plafonnier; bois, acier, marron / plastique, blanc

L 540, B 520, H 90



E27



6x 9W



9 002759 988630

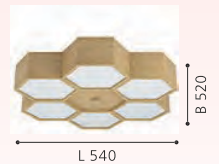



98863



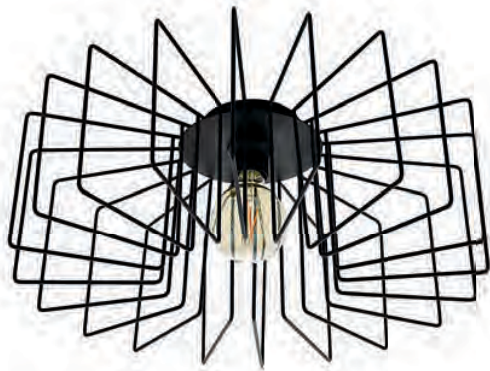

98507



98679



99014

### 98507 TREMEDAL

ceiling light; steel, black  
Deckenleuchte; Stahl, schwarz  
plafonnier; acier, noir

H 215, Ø 560



E27 1x 28W



9 002759 985073

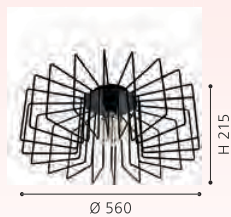

### 98679 MUSARA

ceiling light; steel, black  
Deckenleuchte; Stahl, schwarz  
plafonnier; acier, noir

H 850, Ø 790



E27 6x 60W



9 002759 986797



### 99014 LABARETU

ceiling light; steel, black  
Deckenleuchte; Stahl, schwarz  
plafonnier; acier, noir

L 780, B 60, H 300



E27 4x 60W



9 002759 990145





**99664**

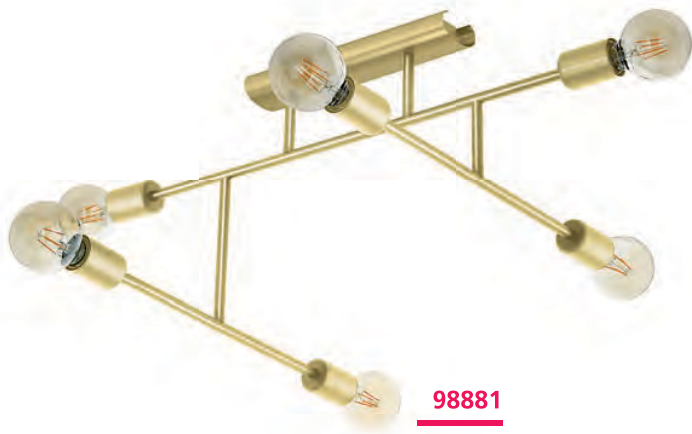

**98881**



**98882**

**99664 ENCINITOS**

ceiling light; steel, black, gold  
Deckenleuchte; Stahl, schwarz, gold  
plafonnier; acier, noir, or

H 260, Ø 450



E27 1x 40W

**98881 BELSIANA 1**

ceiling light; steel, brushed brass  
Deckenleuchte; Stahl, messing-gebürstet  
plafonnier; acier, laiton brossé

L 1155, B 495, H 455



E27 6x 40W

**98882 BELSIANA 1**

ceiling light; steel, brushed brass  
Deckenleuchte; Stahl, messing-gebürstet  
plafonnier; acier, laiton brossé

L 1180, B 380, H 350



E27 8x 40W



9 002759 996642



Ø 450

H 260



9 002759 988814



L 1155

H 455



9 002759 988821



L 1180

H 350



**97904**

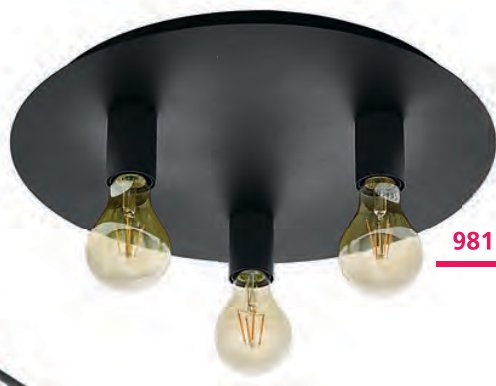

**98156**



**97731**

LED

**97904 STAITI**

ceiling light; steel, black  
Deckenleuchte; Stahl, schwarz  
plafonnier; acier, noir

H 140, Ø 760



E27



7x 60W

**98156 PASSANO 1**

ceiling light; steel, black  
Deckenleuchte; Stahl, schwarz  
plafonnier; acier, noir

H 95, Ø 450



E27



3x 60W

**97731 MONTEBALDO**

ceiling light; steel, black, gold  
Deckenleuchte; Stahl, schwarz, gold  
plafonnier; acier, noir, or

L 380, B 380, H 170



GU10



4x 4,5W



warm  
WHITE

4x  
345lm



9 002759 979041

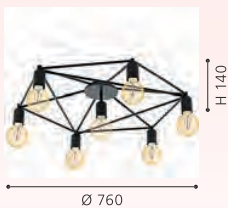

9 002759 981563



9 002759 977313



INCL.







98331



98332



98334

### 98331 SILENTINA

ceiling light; steel, black  
Deckenleuchte; Stahl, schwarz  
plafonnier; acier, noir

L 180, B 180, H 205



E27



1x 40W

### 98332 SILENTINA

ceiling light; steel, black  
Deckenleuchte; Stahl, schwarz  
plafonnier; acier, noir

L 360, B 180, H 205



E27



2x 40W

### 98334 SILENTINA

ceiling light; steel, black  
Deckenleuchte; Stahl, schwarz  
plafonnier; acier, noir

L 360, B 360, H 205



E27



4x 40W



9 002759 983314

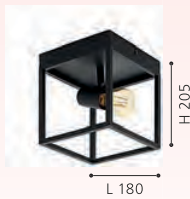

L 180

H 205



9 002759 983321



L 360

H 205



9 002759 983345

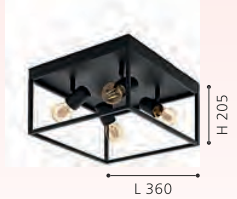

L 360

H 205



**98333**

### 98333 SILENTINA

ceiling light; steel, black  
Deckenleuchte; Stahl, schwarz  
plafonnier; acier, noir

L 540, B 180, H 205



E27



3x 40W





**94547**



**94548**

### 94547 MOGANO

ceiling light; steel, black, copper  
Deckenleuchte; Stahl, schwarz, kupfer  
plafonnier; acier, noir, cuivre

H 170, Ø 400



E27 1x 60W

### 94548 MOGANO

ceiling light; steel, white, silver  
Deckenleuchte; Stahl, weiss, silber  
plafonnier; acier, blanc, argent

H 170, Ø 400



E27 1x 60W

### 43637 MOGANO

ceiling light; steel, black  
Deckenleuchte; Stahl, schwarz  
plafonnier; acier, noir

H 170, Ø 400



E27 1x 60W



9 002759 945473



H 170

Ø 400



9 002759 945480



H 170

Ø 400



9 002759 436377

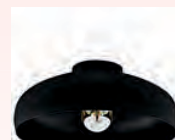

H 170

Ø 400



43637





**92726**



**92813**

### 92726 CONDRADA 1

ceiling light; steel, chrome / satin glass, white  
Deckenleuchte; Stahl, chrom / Glas satiniert, weiss  
plafonnier; acier, chrome / verre satiné, blanc

L 370, B 370, H 235



G9



5x 33W

### 92813 CONDRADA 1

ceiling light; steel, chrome / satin glass, white, clear  
Deckenleuchte; Stahl, chrom / Glas satiniert, weiss, klar  
plafonnier; acier, chrome / verre satiné, blanc, clair

L 770, B 770, H 485



G9



16x 18W

### 92727 CONDRADA 1

ceiling light; steel, chrome / satin glass, white  
Deckenleuchte; Stahl, chrom / Glas satiniert, weiss  
plafonnier; acier, chrome / verre satiné, blanc

L 470, B 470, H 300



G9



8x 18W



9 002759 927264



L 370

H 235



9 002759 928131



L 770

H 485



9 002759 927271



L 470

H 300



99324

LED



99325

LED

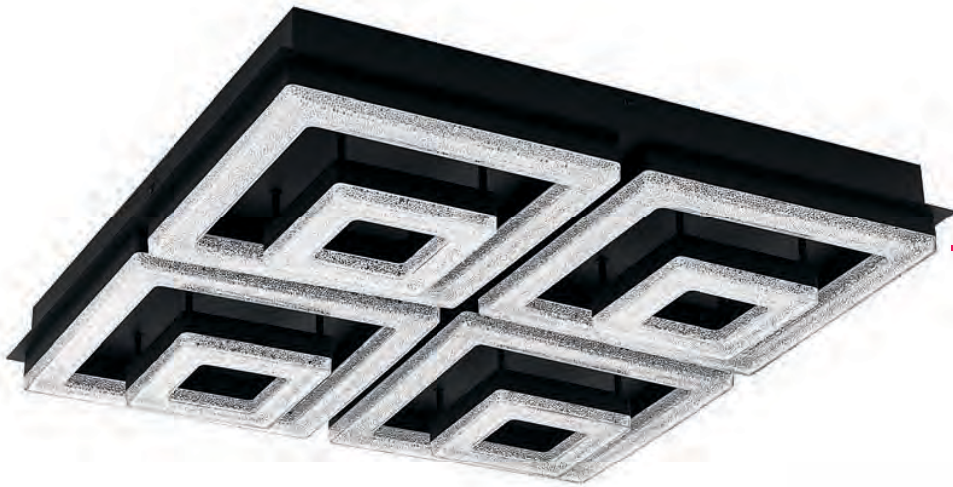

99328

LED

### 99324 FRADELO 1

wall / ceiling light; steel, black / plastic, crystal, black, clear  
Wand- / Deckenleuchte; Stahl, schwarz / Kunststoff, Kristall, schwarz, klar  
applique / plafonnier; acier, noir / plastique, cristal, noir, clair

L 140, B 140, H 60



1x 4W  
1x  
400lm



9 002759 993245

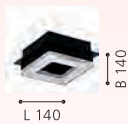

### 99325 FRADELO 1

wall / ceiling light; steel, black / plastic, crystal, black, clear  
Wand- / Deckenleuchte; Stahl, schwarz / Kunststoff, Kristall, schwarz, klar  
applique / plafonnier; acier, noir / plastique, cristal, noir, clair

L 460, B 140, H 60



3x 4W  
3x  
400lm



9 002759 993252

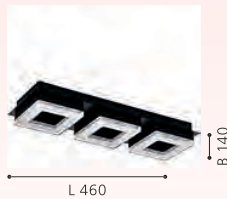

### 99328 FRADELO 1

ceiling light; steel, black / plastic, crystal, black, clear  
Deckenleuchte; Stahl, schwarz / Kunststoff, Kristall, schwarz, klar  
plafonnier; acier, noir / plastique, cristal, noir, clair

L 520, B 520, H 95



12W  
1250lm



9 002759 993283

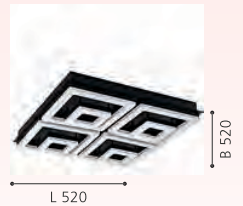



99327

LED

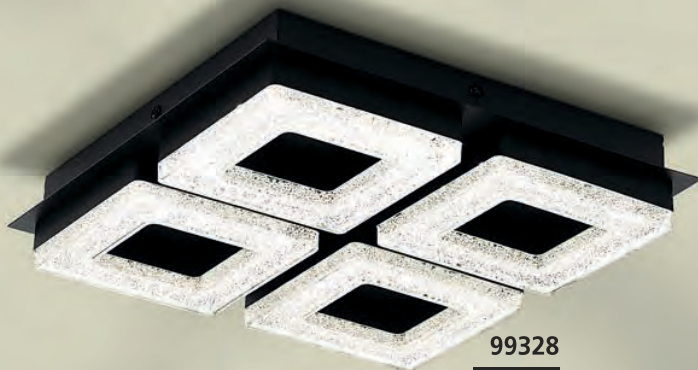

99328

LED



### 99327 FRADELO 1

ceiling light; steel, black / plastic, crystal, black, clear  
 Deckenleuchte; Stahl, schwarz / Kunststoff, Kristall, schwarz, klar  
 plafonnier; acier, noir / plastique, cristal, noir, clair

L 260, B 260, H 85



12W

1250lm

### 99326 FRADELO 1

wall / ceiling light; steel, black / plastic, crystal, black, clear  
 Wand- / Deckenleuchte; Stahl, schwarz / Kunststoff, Kristall, schwarz, klar  
 applique / plafonnier; acier, noir / plastique, cristal, noir, clair

L 280, B 280, H 60



4x 4W

4x  
400lm



9 002759 993276

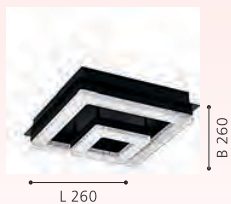

9 002759 993269

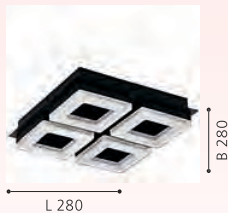

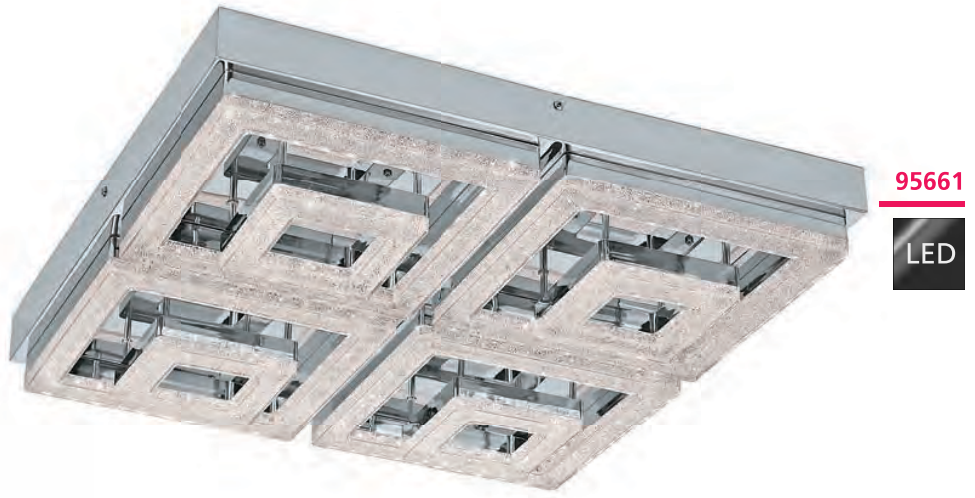
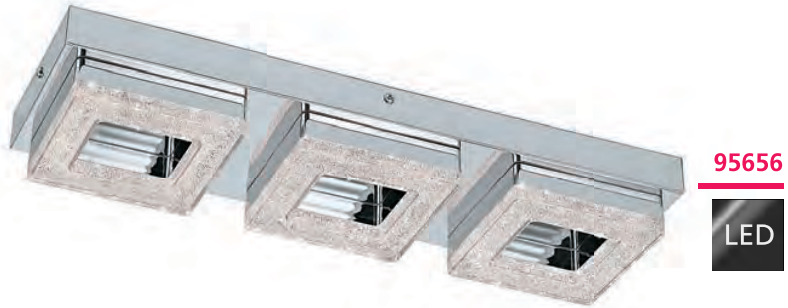

### 95655 FRADELO

wall / ceiling light; steel, chrome / plastic, crystal, chrome, clear  
 Wand- / Deckenleuchte; Stahl, chrom / Kunststoff, Kristall, chrom, klar  
 applique / plafonnier; acier, chrome / plastique, cristal, chrome, clair

L 140, B 140, H 60



1x 4W 400lm

### 95656 FRADELO

wall / ceiling light; steel, chrome / plastic, crystal, chrome, clear  
 Wand- / Deckenleuchte; Stahl, chrom / Kunststoff, Kristall, chrom, klar  
 applique / plafonnier; acier, chrome / plastique, cristal, chrome, clair

L 460, B 140, H 60



3x 4W 1200lm

### 95661 FRADELO

ceiling light; steel, chrome / plastic, crystal, chrome, clear  
 Deckenleuchte; Stahl, chrom / Kunststoff, Kristall, chrom, klar  
 plafonnier; acier, chrome / plastique, cristal, chrome, clair

L 520, B 520, H 95



48W 5000lm



9 002759 956554



9 002759 956561

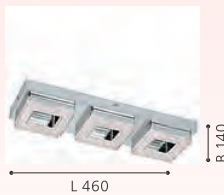

9 002759 956615

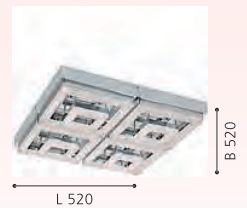



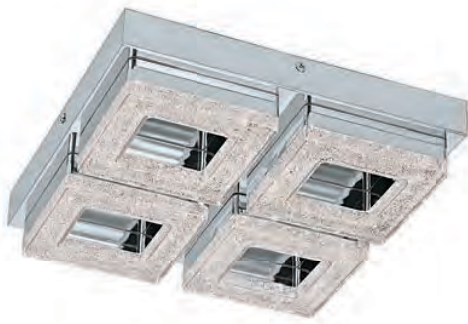

95657

LED

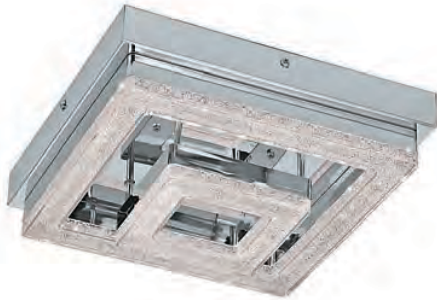

95659

LED



95658

LED



### 95657 FRADELO

wall / ceiling light; steel, chrome / plastic, crystal, chrome, clear  
Wand- / Deckenleuchte; Stahl, chrom / Kunststoff, Kristall, chrom, klar  
applique / plafonnier; acier, chrome / plastique, cristal, chrome, clair

L 280, B 280, H 60



4x 4W 1600lm

### 95659 FRADELO

ceiling light; steel, chrome / plastic, crystal, chrome, clear  
Deckenleuchte; Stahl, chrom / Kunststoff, Kristall, chrom, klar  
plafonnier; acier, chrome / plastique, cristal, chrome, clair

L 260, B 260, H 85



12W 1250lm

### 95658 FRADELO

wall / ceiling light; steel, chrome / plastic, crystal, chrome, clear  
Wand- / Deckenleuchte; Stahl, chrom / Kunststoff, Kristall, chrom, klar  
applique / plafonnier; acier, chrome / plastique, cristal, chrome, clair

L 440, B 440, H 70



9x 4W 3600lm



9 002759 956578



9 002759 956592

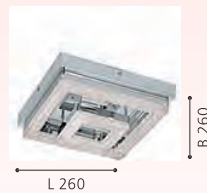

9 002759 956585

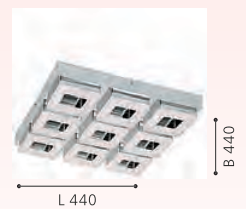



95662

LED

DESIGN  
HIGHLIGHT  
DETAIL



95663

LED

### 95662 FRADELO

wall / ceiling light; steel, chrome / plastic, crystal, chrome, clear  
Wand- / Deckenleuchte; Stahl, chrom / Kunststoff, Kristall, chrom, klar

applique / plafonnier; acier, chrome / plastique, cristal, chrome, clair

L 140, B 140, H 60



1x 4W 400lm



9 002759 956622



### 95663 FRADELO

wall / ceiling light; steel, chrome / plastic, crystal, chrome, clear  
Wand- / Deckenleuchte; Stahl, chrom / Kunststoff, Kristall, chrom, klar

applique / plafonnier; acier, chrome / plastique, cristal, chrome, clair

L 460, B 140, H 60



3x 4W 1200lm



9 002759 956639



### 95664 FRADELO

wall / ceiling light; steel, chrome / plastic, crystal, chrome, clear  
Wand- / Deckenleuchte; Stahl, chrom / Kunststoff, Kristall, chrom, klar

applique / plafonnier; acier, chrome / plastique, cristal, chrome, clair

L 280, B 280, H 60



4x 4W 1600lm



9 002759 956646





95664

LED





32025

LED



32026

LED



98597

LED

### 32025 CARDITO

ceiling light; steel, chrome / glass, crystal, clear  
Deckenleuchte; Stahl, chrom / Glas, Kristall, klar  
plafonnier; acier, chrome / verre, cristal, clair

L 320, B 320, H 55



16W 1700lm

### 32026 CARDITO

ceiling light; steel, chrome / glass, crystal, clear  
Deckenleuchte; Stahl, chrom / Glas, Kristall, klar  
plafonnier; acier, chrome / verre, cristal, clair

L 440, B 440, H 55



4x 6,7W 3400lm

### 98597 FUERTESCUSA

wall light; steel, chrome / crystal, clear  
Wandleuchte; Stahl, chrom / Kristall, klar  
applique; acier, chrome / cristal, clair

L 130, H 130, A 110



G9 1x 3W 1x 360lm



9 002759 320256



L 320

B 320



9 002759 320263



L 440

B 440



9 002759 985974



INCL.



L 130

H 130





98527

LED

incl./inkl./inclus



 <b>TUNABLE WHITE</b>	 <b>STEP DIMMING</b>	 <b>NIGHT LIGHT FUNCTION</b>	<b>98527</b>  <b>98685</b>
<ol style="list-style-type: none"> <li>1. warmwhite (2700K/100%)</li> <li>2. neutralwhite 3850K (2700K/50% + 5000K/50%)</li> <li>3. coldwhite (5000K/100%)</li> </ol>			



98685

LED

incl./inkl./inclus



### 98527 CANICOSA 2

wall / ceiling light; plastic, steel, black, gold / plastic with granille, transparent

Wand- / Deckenleuchte; Kunststoff, Stahl, schwarz, gold / Kunststoff mit Granille, transparent

applique / plafonnier; plastique, acier, noir, or / plastique avec granille, transparent

H 90, Ø 495



24,5W



3000lm



remote



### 98685 CANICOSA 2

wall / ceiling light; plastic, steel, black, gold / plastic with granille, transparent

Wand- / Deckenleuchte; Kunststoff, Stahl, schwarz, gold / Kunststoff mit Granille, transparent

applique / plafonnier; plastique, acier, noir, or / plastique avec granille, transparent

H 145, Ø 765



37W



4600lm



remote



9 002759 985271



9 002759 986858

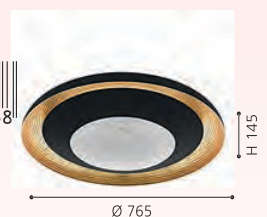



## MALVA

This luminaire comes with a hand-made glass with a special wipe technique.

Diese Leuchte besitzt ein handgemachtes Glas mit spezieller Wischtechnik.

Cette luminaire viens avec un verre de luxe faitmain avec un technique à l'essuyé.



90015



86712



82741

### 90015 MALVA

wall / ceiling light; steel, white / glass wiping technique, beige  
Wand- / Deckenleuchte; Stahl, weiss / Glas Wischtechnik, beige  
applique / plafonnier; acier, blanc / technique d'essuie de verre, beige

H 95, Ø 315



E27 1x 25W

### 86712 MESTRE

wall / ceiling light; steel, antique-brown, gold / glass chalked, beige  
Wand- / Deckenleuchte; Stahl, antik-braun, gold / Glas gekalkt, beige  
applique / plafonnier; acier, marron antique, or / verre chaulé, beige

H 133, Ø 395



E27 2x 60W

### 82741 IMPERIAL

wall / ceiling light; cast metal, bronzed / satin glass, white  
Wand- / Deckenleuchte; Metallguss, brüniert / Glas satiniert, weiss  
applique / plafonnier; fonte métallique, bruni / verre satiné, blanc

H 140, Ø 310



E27 2x 25W



9 002759 900151



Ø 315



9 002759 867126



Ø 395



9 002759 827410



Ø 310

H 140



**86715**



GL1932

**89115**



**87793**

### 89115 ALMERA

wall light; steel, antique-brown / glass, champagne  
Wandleuchte; Stahl, antik-braun / Glas, champagner  
applique; acier, marron antique / verre, champagne

L 180, H 250, A 75



E14 1x 60W



9 002759 891152



L 180

### 86715 MESTRE

wall light; steel, antique-brown, gold / glass chalked, beige  
Wandleuchte; Stahl, antik-braun, gold / Glas gekalkt, beige  
applique; acier, marron antique, or / verre chaulé, beige

L 300, H 335, A 160



E27 1x 60W



9 002759 867157



L 300

### 87793 PASCAL 1

wall light; steel, antique-brown / glass chalked, beige  
Wandleuchte; Stahl, antik-braun / Glas gekalkt, beige  
applique; acier, marron antique / verre chaulé, beige

L 180, H 480, A 120



E14 1x 60W



9 002759 877934



L 180



90737

90737, 90697

Rustic luminaire series with appealing leaf decor

Rustikale Leuchtenserie mit ansprechendem Blätterdekor

Série de luminaires rustique avec un décor de feuille plaisant



90697

### 90737 CAMPANIA

ceiling light; steel, antique-brown, gold / glass chalked, white  
Deckenleuchte; Stahl, antik-braun, gold / Glas gekalkt, weiss  
plafonnier; acier, marron antique, or / verre chaulé, blanc

H 115, Ø 775



G4 15x 10W



9 002759 907372

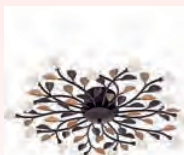

Ø 775

### 90697 GERBERA 1

ceiling light; steel, antique-brown, gold / satin glass, white  
Deckenleuchte; Stahl, antik-braun, gold / Glas satiniert, weiss  
plafonnier; acier, marron antique, or / verre satiné, blanc

H 90, Ø 780



G9 6x 33W



9 002759 906979



Ø 780

### 92143 COLTI

ceiling light; steel, antique-brown / satin glass, white painted  
Deckenleuchte; Stahl, antik-braun / Glas satiniert, weiss lackiert  
plafonnier; acier, marron antique / verre satiné, blanc laqué

H 95, Ø 350



E27 2x 25W



9 002759 921439



Ø 350





92143



**99349**



**97886**



**99348**

Matching fabric luminaires can be found from page 100.

Passende Stoffleuchten finden Sie ab Seite 100.

Vous trouverez les luminaires à textile assorties à partir de la page 100.

### 99349 TABILLANO 1

wall light; steel, black  
Wandleuchte; Stahl, schwarz  
applique; acier, noir

L 160, H 250, A 500



E27 1x 40W



9 002759 993498

### 97886 SAN PERI

wall light; steel, black  
Wandleuchte; Stahl, schwarz  
applique; acier, noir

L 130, B 300, H 210



E27 1x 10W



9 002759 978860

### 99348 STAITI 1

wall light; steel, black / fabric, black  
Wandleuchte; Stahl, schwarz / Textil, schwarz  
applique; acier, noir / tissu, noir

L 160, H 240, A 500



E27 1x 40W

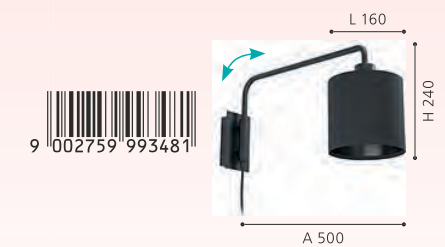

9 002759 993481



99348



99069

LED



99126

LED



## GALDAKAO

These luminaires have a shelf.

Diese Leuchten verfügen über eine Ablagefläche.

Ces luminaires ont une étagère.

### 99069 GALDAKAO

wall light; steel, black / fabric, white  
Wandleuchte; Stahl, schwarz / Textil, weiss  
applique; acier, noir / tissu, blanc

L 200, H 320, A 125



LED  
1x 5,4W  
warm  
WHITE  
1x  
410lm



9 002759 990695



A 125

### 99126 GALDAKAO

wall light; steel, wood, black, natural / fabric, white  
Wandleuchte; Stahl, Holz, schwarz, natur / Textil, weiss  
applique; acier, bois, noir, nature / tissu, blanc

L 200, H 350, A 135, Base: B 200, T 125



LED  
5,4W  
warm  
WHITE  
540lm



9 002759 991265



A 135



98263

LED



98265



98265



### 98263 CIGLIE

wall light; aluminium, steel, black  
Wandleuchte; Alu, Stahl, schwarz  
applique; aluminium, acier, noir

L 180, H 180, A 210

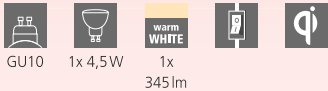

### 98265 CIGLIE

wall light; cast aluminium, black / glass opal-matt, white  
Wandleuchte; Aluguss, schwarz / Glas opal-matt, weiss  
applique; fonte d'aluminium, noir / verre opale mat, blanc

L 180, H 180, A 210

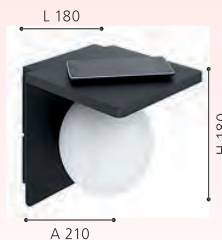

### CIGLIE

These luminaires have a Qi charging function. They can wirelessly charge Qi-compatible Smartphones by inductive energy transfer.

Diese Leuchten besitzen eine Qi-Ladefunktion. Damit können Qi-kompatible Smartphones über induktive Energieübertragung kabellos geladen werden.

Ces luminaires disposent d'une fonction de chargement Qi. Cela permet aux smartphones compatibles Qi d'être chargés sans fil par transmission d'énergie inductive.

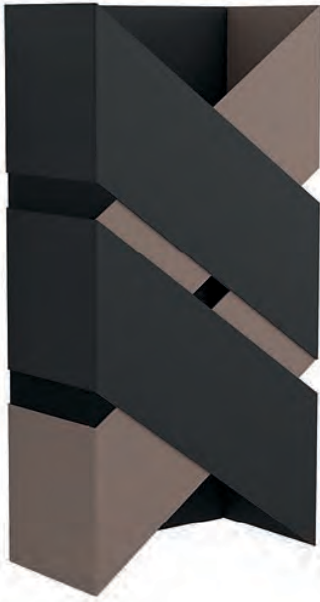

99689

LED



98841

LED

### 98841 ZINACUA

wall light; steel, silver  
Wandleuchte; Stahl, silber  
applique; acier, argent

L 225, H 310, A 85



GU10



4x 4,5W



4x  
warm  
WHITE

345lm



9 002759 988418

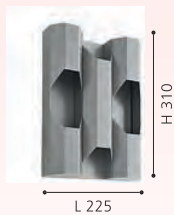



96049

LED



99112



96048

LED



### 99112 BELATEGI

wall light; steel, black / glass vaporized, black-transparent, clear  
Wandleuchte; Stahl, schwarz / Glas bedampft, schwarz-transparent, klar  
applique; acier, noir / verre vaporisé, noir transparent, clair

Ø 240, A 180



E27



1x 40W



### 96049 ONO 2

wall light; aluminium, anthracite / plastic, clear  
Wandleuchte; Alu, anthrazit / Kunststoff, klar  
applique; aluminium, anthracite / plastique, clair

L 90, H 80, A 130



2x 2,5W



460lm



### 96048 ONO 2

wall light; aluminium, white / plastic, clear  
Wandleuchte; Alu, weiss / Kunststoff, klar  
applique; aluminium, blanc / plastique, clair

L 90, H 80, A 130



2x 2,5W



460lm



9 002759 991128



Ø 240



9 002759 960490



A 130

H 80



9 002759 960483



A 130

H 80



98542

LED



98541

LED

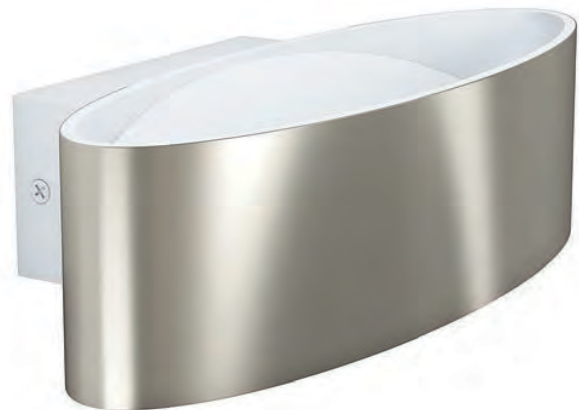

98543

LED

### 98541 MACCARI

wall light; aluminium, steel, white / plastic, transparent  
Wandleuchte; Alu, Stahl, weiss / Kunststoff, transparent  
applique; aluminium, acier, blanc / plastique, transparent

L 270, H 75, A 130



10W 1100lm



9 002759 985417



### 98542 MACCARI

wall light; aluminium, steel, black, gold / plastic, transparent  
Wandleuchte; Alu, Stahl, schwarz, gold / Kunststoff, transparent  
applique; aluminium, acier, noir, or / plastique, transparent

L 270, H 75, A 130



10W 1100lm



9 002759 985424



### 98543 MACCARI

wall light; aluminium, steel, white, satin nickel / plastic, transparent  
Wandleuchte; Alu, Stahl, weiss, nickel-matt / Kunststoff, transparent  
applique; aluminium, acier, blanc, nickel mat / plastique, transparent

L 270, H 75, A 130



10W 1100lm



9 002759 985431

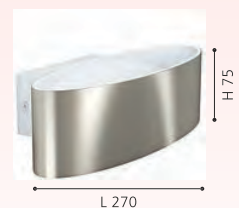





**98544**

LED



**98545**

LED

### 98544 FELONICHE

wall light; aluminium, white / plastic, transparent  
 Wandleuchte; Alu, weiss / Kunststoff, transparent  
 applique; aluminium, blanc / plastique, transparent

L 220, H 100, A 75



10W



1100lm



### 98545 FELONICHE

wall light; aluminium, black, gold / plastic, transparent  
 Wandleuchte; Alu, schwarz, gold / Kunststoff, transparent  
 applique; aluminium, noir, or / plastique, transparent

L 220, H 100, A 75



10W



1100lm



9 002759 985448



L 220



9 002759 985455



L 220



98421

LED



98422

LED



98423

LED

### 98421 SANIA 4

wall light; aluminium, white  
Wandleuchte; Alu, weiss  
applique; aluminium, blanc

L 130, H 80, A 90



6W 600lm

### 98422 SANIA 4

wall light; aluminium, white  
Wandleuchte; Alu, weiss  
applique; aluminium, blanc

L 200, H 80, A 90



10W 1100lm

### 98423 SANIA 4

wall light; aluminium, white  
Wandleuchte; Alu, weiss  
applique; aluminium, blanc

L 365, H 80, A 90



12W 1400lm



9 002759 984212



L 130

H 80



9 002759 984229



L 200

H 80



9 002759 984236



L 365

H 80



98424

LED



98425

LED



98426

LED

### 98424 SANIA 4

wall light; aluminium, satin nickel  
Wandleuchte; Alu, nickel-matt  
applique; aluminium, nickel mat

L 130, H 80, A 90



6W 600lm

### 98425 SANIA 4

wall light; aluminium, satin nickel  
Wandleuchte; Alu, nickel-matt  
applique; aluminium, nickel mat

L 200, H 80, A 90



10W 1100lm

### 98426 SANIA 4

wall light; aluminium, satin nickel  
Wandleuchte; Alu, nickel-matt  
applique; aluminium, nickel mat

L 365, H 80, A 90



12W 1400lm



9 002759 984243



L 130

H 80



9 002759 984250



L 200

H 80



9 002759 984267



L 365

H 80



96261

LED



### 96261 PASSA

wall light; steel, satin nickel, chrome  
Wandleuchte; Stahl, nickel-matt, chrom  
applique; acier, nickel mat, chrome

L 60, H 170, A 85



GU10



2x 3 W



warm  
WHITE

2x

250 lm



9 002759 962616



INCL.

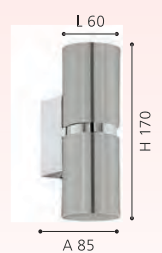



96264

LED



95368

LED



95377

LED

### 96264 PASSA

wall light; steel, satin nickel, chrome  
Wandleuchte; Stahl, nickel-matt, chrom  
applique; acier, nickel mat, chrome

L 55, H 170, A 85



GU10



2x 3W



warm  
WHITE  
2x  
250lm



9 002759 962647



### 95368 PASSA

wall light; steel, chrome, white  
Wandleuchte; Stahl, chrom, weiss  
applique; acier, chrome, blanc

L 60, H 170, A 85



GU10



2x 3W



warm  
WHITE  
2x  
250lm



9 002759 953683



### 95377 PASSA

wall light; steel, chrome, white  
Wandleuchte; Stahl, chrom, weiss  
applique; acier, chrome, blanc

L 55, H 170, A 85



GU10



2x 3W



warm  
WHITE  
2x  
250lm



9 002759 953775



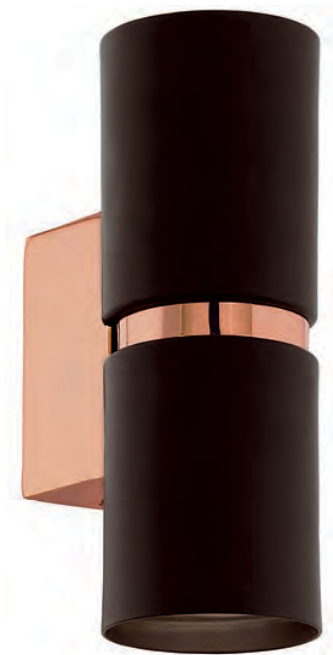

95371

LED



95379

LED

### 95371 PASSA

wall light; steel, brown, copper  
Wandleuchte; Stahl, braun, kupfer  
applique; acier, marron, cuivre

L 60, H 170, A 85

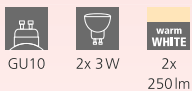

9 002759 953713



### 95379 PASSA

wall light; steel, brown, copper  
Wandleuchte; Stahl, braun, kupfer  
applique; acier, marron, cuivre

L 55, H 170, A 85

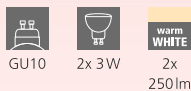

9 002759 953799



### 95364 PASSA

wall light; steel, black, gold  
Wandleuchte; Stahl, schwarz, gold  
applique; acier, noir, or

L 60, H 170, A 85

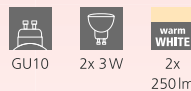

9 002759 953645





95364

LED



95373

LED

### 95373 PASSA

wall light; steel, black, gold  
Wandleuchte; Stahl, schwarz, gold  
applique; acier, noir, or

L 55, H 170, A 85



GU10



2x 3W



2x

250lm



9 002759 953737





98379



98755

### 98379 GASCUERIA

wall light; plastic, steel, gold, black  
Wandleuchte; Kunststoff, Stahl, gold, schwarz  
applique; plastique, acier, or, noir

L 290, H 330, A 130



E27 1x 60W



H 330

A 130



9 002759 983796

### 98755 ELIZONDO

wall light; steel, black, gold  
Wandleuchte; Stahl, schwarz, gold  
applique; acier, noir, or

L 80, H 270, A 115



E14 1x 40W

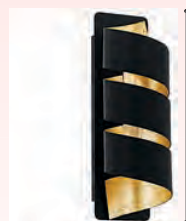

H 270

A 115



9 002759 987558

### 98759 FALICETTO

wall light; steel, black, gold  
Wandleuchte; Stahl, schwarz, gold  
applique; acier, noir, or

L 160, H 250, A 115



E27 1x 40W



H 250

A 115



9 002759 987596





98759





98888

LED



96038

LED



96037

LED

### 98888 METRASS

wall light; aluminium, black / plastic, satiné  
Wandleuchte; Alu, schwarz / Kunststoff, satiniert  
applique; aluminium, noir / plastique, satiné

L 200, H 105, A 60



1x 5,6W  
1x  
680lm



9 002759 988883



L 200

H 105

### 96037 METRASS

wall light; aluminium, white / plastic, satiné  
Wandleuchte; Alu, weiss / Kunststoff, satiniert  
applique; aluminium, blanc / plastique, satiné

L 200, H 105, A 60



1x 5,6W  
1x  
680lm



9 002759 960377



L 200

H 105

### 96038 METRASS

wall light; aluminium, satin nickel / plastic, satiné  
Wandleuchte; Alu, nickel-matt / Kunststoff, satiniert  
applique; aluminium, nickel mat / plastique, satiné

L 200, H 105, A 60



1x 5,6W  
1x  
680lm



9 002759 960384



L 200

H 105



96042

LED



96043

LED

### 96042 METRASS 2

wall / ceiling light; aluminium, white / plastic, satined  
Wand- / Deckenleuchte; Alu, weiss / Kunststoff, satiniert  
applique / plafonnier; aluminium, blanc / plastique, satiné

L 170, H 200, A 55



2x 4,5W



2x  
480lm



L 170

H 200



9 002759 960421

### 96043 METRASS 2

wall / ceiling light; aluminium, satin nickel / plastic, satined  
Wand- / Deckenleuchte; Alu, nickel-matt / Kunststoff, satiniert  
applique / plafonnier; aluminium, nickel mat / plastique, satiné

L 170, H 200, A 55



2x 4,5W



2x  
480lm



L 170

H 200



9 002759 960438

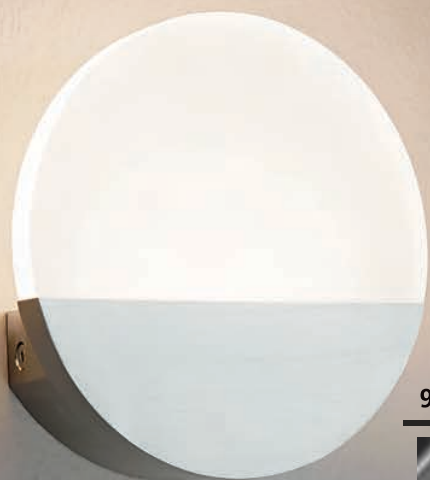

96039

LED



96041

LED

### 96039 METRASS 1

wall light; aluminium, white / plastic, satiné  
Wandleuchte; Alu, weiss / Kunststoff, satiniert  
applique; aluminium, blanc / plastique, satiné

L 130, H 130, A 50

LED

1x 4,5W

warm  
WHITE

1x  
480lm



9 002759 960391



L 130

H 130

# BATH & MIRROR LUMINAIRES

BAD- & SPIEGELLEUCHTEN

LUMINAIRES DE BAIN & MIROIR

## PURE RELAXATION -

Turn your bathroom into your personal wellness oasis. Trendy bathroom and mirror luminaires give a pleasant light and ensure relaxation and comfort.

## ENTSPANNUNG PUR -

Verwandeln Sie Ihr Badezimmer in eine persönliche Wohlfühloase. Trendige Bad- und Spiegelleuchten spenden ein angenehmes Licht und sorgen für Entspannung und Ihr Wohlbefinden.



## DE LA PURE DÉTENTE -

Transformez votre salle de bains en un îlot personnel de bien-être. Des éclairages à la mode de miroirs et de bain confèrent une lumière agréable et vous assurent de la détente et du bien-être.



BATH & MIRROR LUMINAIRES

# COLOUR RENDERING INDEX

FARBWIEDERGABE-INDEX

L'INDICE DE RESTITUTION DE COULEURS

## QUALITY CRITERION COLOUR RENDERING

The colour rendering index Ra describes the colour rendering quality of lamps. The higher the Ra value, the less will the artificial light change the colour of an object. The maximum Ra value (e.g. the Ra value of the sun) is 100.

Therefore, lamps with an Ra above 90 will make you look better.

Lamps with an Ra value above 90 are marked with this button: 

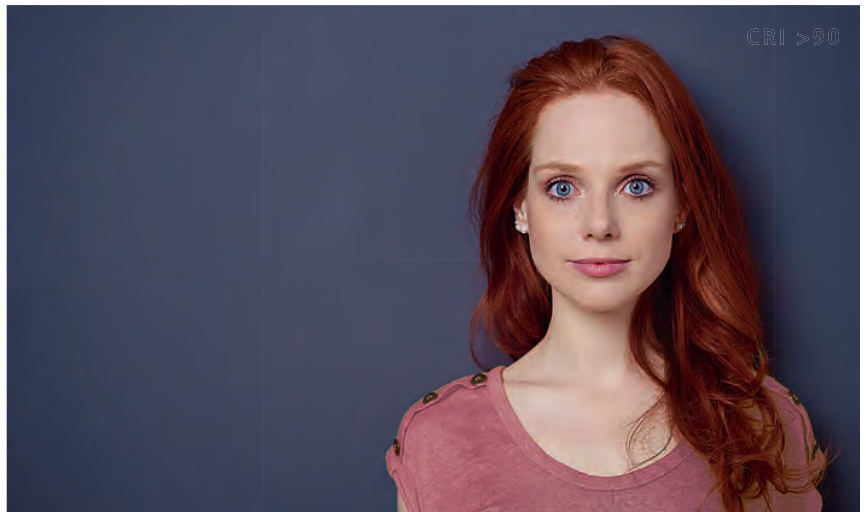

## QUALITÄTSKRITERIUM FARBWIEDERGABE

Mit dem Farbwiedergabe-Index Ra wird die Qualität der Farbwiedergabe von Leuchten beschrieben. Je höher der Ra-Wert ist, desto weniger verfälscht das künstliche Licht die Farbe von Objekten. Der maximale Ra-Wert (z.B. der Ra-Wert der Sonne) ist 100.

Leuchten mit Ra >90 lassen Sie somit besser aussehen.

Leuchten die einen Ra-Wert von >90 haben, sind mit diesem Button gekennzeichnet: 



## CRITÈRE DE QUALITÉ INDIQUANT LA RESTITUTION DES COULEURS

L'indice de restitution de couleurs Ra décrit la qualité de restitution des éclairages. Plus la valeur Ra est élevée, moins la lumière artificielle falsifie la couleur des objets. La valeur Ra maximale (par ex. la valeur Ra du soleil) est 100.

Ainsi, favorisez des lampes avec une valeur Ra > 90.

Les lampes ayant une valeur Ra > 90 sont identifiées par ce bouton: 



99122



99124



99122 | 99123 | 99124

### 99122 AMEZOLA

wall / ceiling light; steel, black / glass, clear  
Wand- / Deckenleuchte; Stahl, schwarz / Glas, klar  
applique / plafonnier; acier, noir / verre, clair

L 290, H 290, A 130



E27 2x 40W IP44



9 002759 991227



L 290

H 290

### 99124 AMEZOLA

wall light; steel, black / glass, clear  
Wandleuchte; Stahl, schwarz / Glas, klar  
applique; acier, noir / verre, clair

L 110, H 380, A 100



E27 2x 60W IP44



9 002759 991241



A 100

H 380

### 99123 AMEZOLA

wall light; steel, black / glass, clear  
Wandleuchte; Stahl, schwarz / Glas, klar  
applique; acier, noir / verre, clair

L 110, H 260, A 100



E27 1x 60W IP44



9 002759 991234



A 100

H 260





99123

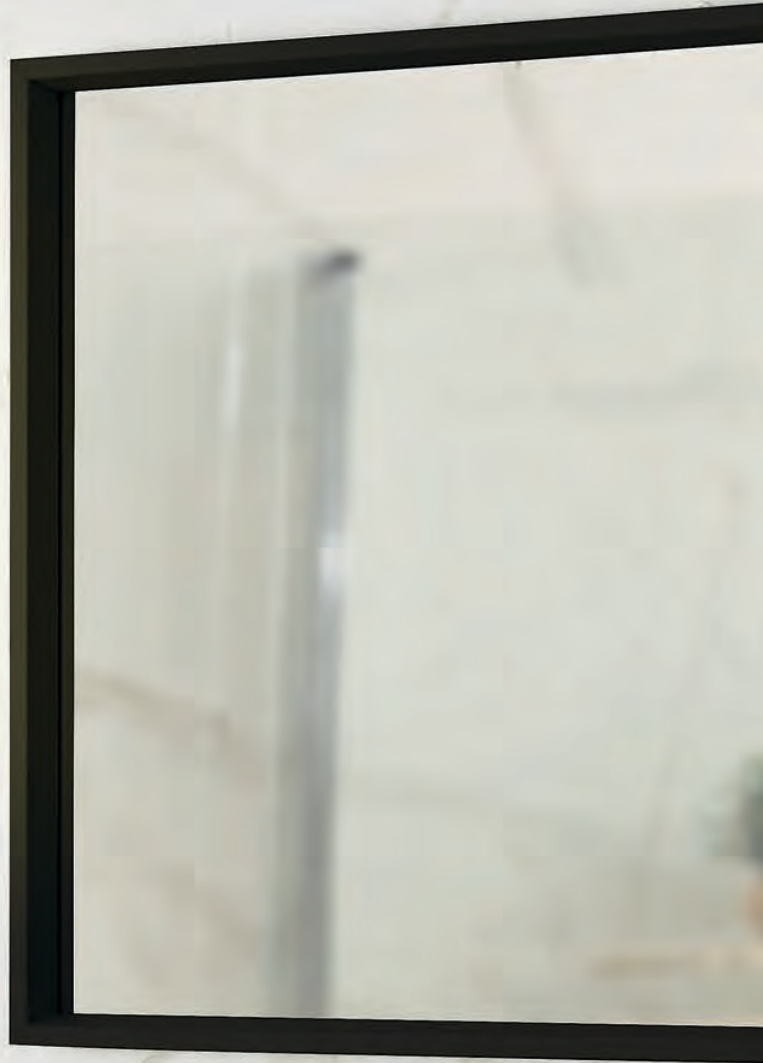

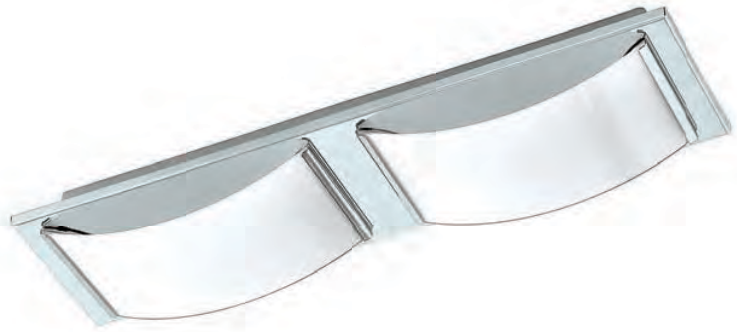

94882

LED



94881

LED



94884

LED

### 94881 WASAO 1

wall / ceiling light; stainless steel, chrome / glass painted, white  
Wand- / Deckenleuchte; Edelstahl, chrom / Glas lackiert, weiss  
applique / plafonnier; acier inoxydable, chrome / verre laqué, blanc

L 210, B 105, A 60



1x 5,4W 510lm



9 002759 948818



### 94882 WASAO 1

wall / ceiling light; stainless steel, chrome / glass painted, white  
Wand- / Deckenleuchte; Edelstahl, chrom / Glas lackiert, weiss  
applique / plafonnier; acier inoxydable, chrome / verre laqué, blanc

L 420, B 105, H 60



2x 5,4W 2x 510lm



9 002759 948825



### 94884 WASAO 1

wall / ceiling light; stainless steel, chrome / glass painted, white  
Wand- / Deckenleuchte; Edelstahl, chrom / Glas lackiert, weiss  
applique / plafonnier; acier inoxydable, chrome / verre laqué, blanc

L 320, B 320, H 60



4x 5,4W 4x 510lm



9 002759 948849

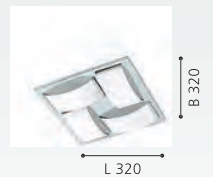

## 94883 WASAO 1

wall / ceiling light; stainless steel, chrome / glass painted, white  
Wand- / Deckenleuchte; Edelstahl, chrom / Glas lackiert, weiss  
applique / plafonnier; acier inoxydable, chrome / verre laqué,  
blanc

L 630, B 105, H 60

LED

3x 5,4W

warm  
WHITE

3x  
510lm



IP44



L 630

B 105



94883

LED



96231

LED



96229

LED



97885

LED

### 97885 FRANIA

wall / ceiling light; steel, white / plastic, white  
Wand- / Deckenleuchte; Stahl, weiss / Kunststoff, weiss  
applique / plafonnier; acier, blanc / plastique, blanc

L 330, B 330, H 70



17,3W 2000lm

### 96231 MANILVA 1

wall light; steel, satin nickel / plastic, white  
Wandleuchte; Stahl, nickel-matt / Kunststoff, weiss  
applique; acier, nickel mat / plastique, blanc

L 290, B 290, H 70



16W 1500lm

### 96229 MANILVA 1

wall light; steel, chrome / plastic, white  
Wandleuchte; Stahl, chrom / Kunststoff, weiss  
applique; acier, chrome / plastique, blanc

L 290, B 290, H 70



16W 1500lm



9 002759 978853



L 330

B 330



9 002759 962319



L 290

B 290



9 002759 962296



L 290

B 290



96541

LED

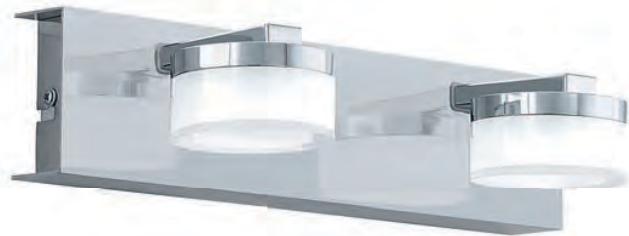

96542

LED



96544

LED

### 96541 ROMENDO 1

wall light; steel, chrome / plastic, clear, satiné  
Wandleuchte; Stahl, chrom / Kunststoff, klar, satiniert  
applique; acier, chrome / plastique, clair, satiné

L 70, H 155, A 120

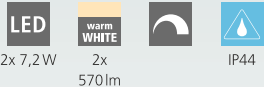

### 96542 ROMENDO 1

wall light; steel, chrome / plastic, clear, satiné  
Wandleuchte; Stahl, chrom / Kunststoff, klar, satiniert  
applique; acier, chrome / plastique, clair, satiné

L 300, H 70, A 125



### 96544 ROMENDO 1

ceiling light; steel, chrome / plastic, clear, satiné  
Deckenleuchte; Stahl, chrom / Kunststoff, klar, satiniert  
plafonnier; acier, chrome / plastique, clair, satiné

L 320, B 320, H 70



9 002759 965419



L 70

H 155



9 002759 965426



L 300

H 70



9 002759 965440



L 320

B 320

96543

LED



### ROMENDO 1

These luminaires are dimmable.

Diese Leuchten sind dimmbar.

Ces luminaires sont graduables.

### 96543 ROMENDO 1

wall light; steel, chrome / plastic, clear, satined  
Wandleuchte; Stahl, chrom / Kunststoff, klar, satiniert  
applique; acier, chrome / plastique, clair, satiné

L 450, H 70, A 125

LED

3x 7,2W

warm  
WHITE

3x

570lm



IP44



L 450

H 70



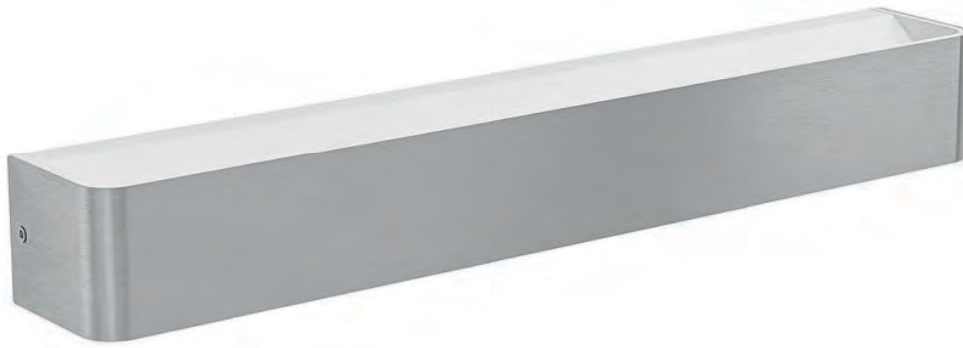

99692

LED

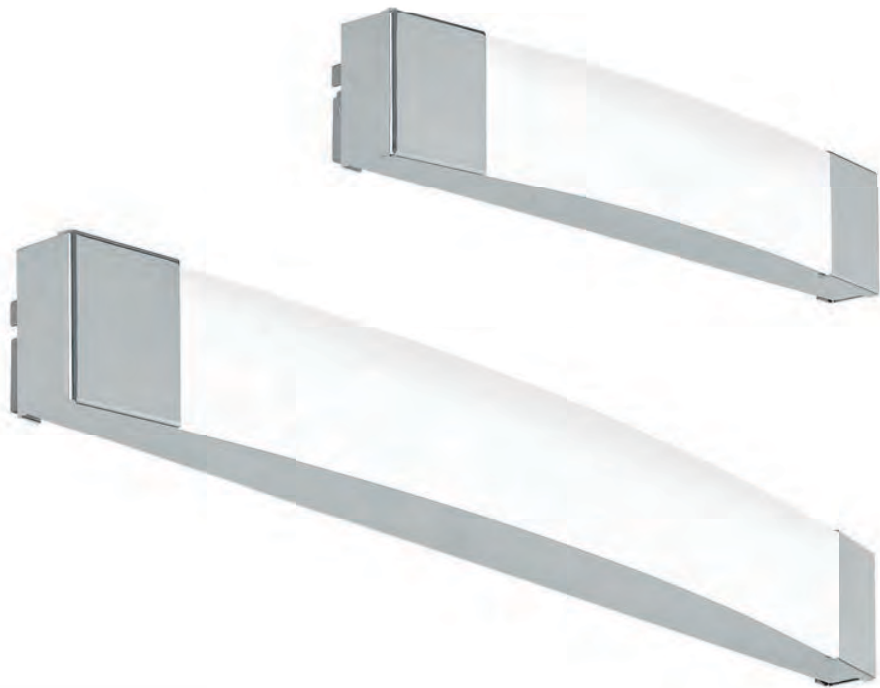

97718

LED

97719

LED

### 97718 SIDERNO

mirror light; steel, chrome / plastic, satiné  
Spiegelleuchte; Stahl, chrom / Kunststoff, satiniert  
applique pour miroir; acier, chrome / plastique, satiné

L 350, B 60, A 55



8,3W 900lm

### 97719 SIDERNO

mirror light; steel, chrome / plastic, satiné  
Spiegelleuchte; Stahl, chrom / Kunststoff, satiniert  
applique pour miroir; acier, chrome / plastique, satiné

L 580, B 60, A 65



16W 1700lm

### 99692 SANIA 5

wall light; steel, satin nickel, white / plastic, satiné  
Wandleuchte; Stahl, nickel-matt, weiss / Kunststoff, satiniert  
applique; acier, nickel mat, blanc / plastique, satiné

L 620, H 80, A 90



26,5W 2700lm



9 002759 977184

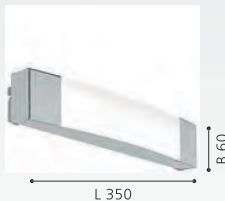

9 002759 977191

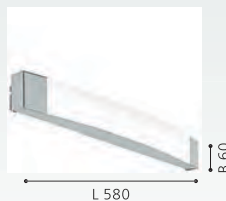

9 002759 996925



99691

LED



### 99691 SANIA 5

wall light; steel, black, white / plastic, satiné  
Wandleuchte; Stahl, schwarz, weiss / Kunststoff, satiniert  
applique; acier, noir, blanc / plastique, satiné

L 620, H 80, A 90

LED

26,5W

warm  
WHITE

2700lm



IP44



9 002759 996918

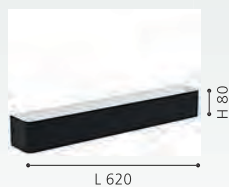





99339

LED

### 99339 TRAGACETE 1

mirror light; aluminium, silver, chrome / plastic, white  
 Spiegelleuchte; Alu, silber, chrom / Kunststoff, weiss  
 applique pour miroir; aluminium, argent, chrome / plastique, blanc

L 680, B 55, H 70

LED

15W

neutral  
 WHITE

1600lm



IP44

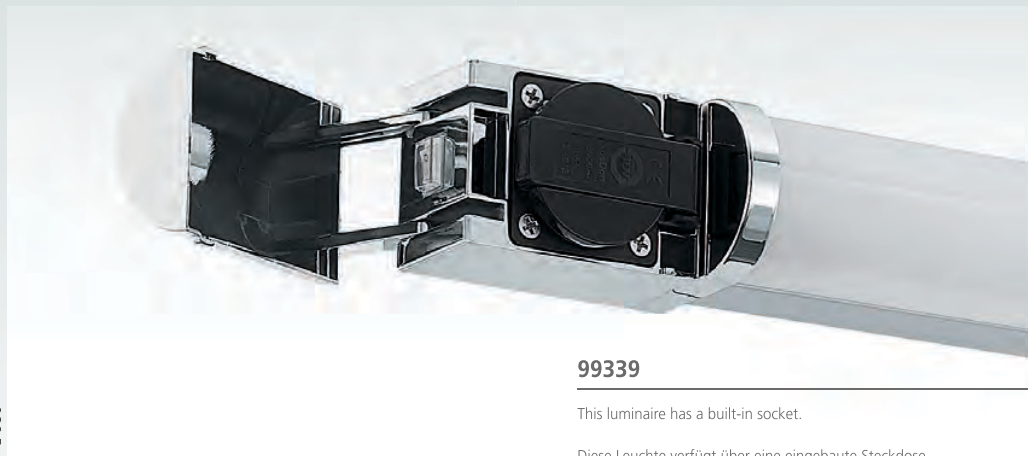

### 99339

This luminaire has a built-in socket.

Diese Leuchte verfügt über eine eingebaute Steckdose.

Cette luminaire a une douille intégrée.



9 002759 993399





DESIGN  
HIGHLIGHT  
DETAIL



**94712**  
LED



**94713**  
LED

**94712 GITA 2**

wall / ceiling light; cast metal, chrome / plastic, white  
Wand- / Deckenleuchte; Metallguss, chrom / Kunststoff, weiss  
applique / plafonnier; fonte métallique, chrome / plastique,  
blanc

L 350, B 75, H 75



**94713 GITA 2**

wall / ceiling light; cast metal, chrome / plastic, white  
Wand- / Deckenleuchte; Metallguss, chrom / Kunststoff, weiss  
applique / plafonnier; fonte métallique, chrome / plastique,  
blanc

L 600, B 75, H 75



**94714 GITA 2**

wall / ceiling light; cast metal, chrome / plastic, white  
Wand- / Deckenleuchte; Metallguss, chrom / Kunststoff, weiss  
applique / plafonnier; fonte métallique, chrome / plastique,  
blanc

L 900, B 75, H 75

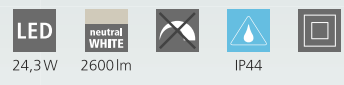



94714

LED

DESIGN  
HIGHLIGHT  
DETAIL



94715

LED



94716

LED



94717

LED

### 94715 CALNOVA

wall light; steel, satin nickel / satin glass, white  
Wandleuchte; Stahl, nickel-matt / Glas satiniert, weiss  
applique; acier, nickel mat / verre satiné, blanc

L 350, B 50, A 85

LED

8W

neutral  
WHITE

770lm



IP44



9 002759 947156

CRI  
>90



A 85

### 94716 CALNOVA

wall light; steel, satin nickel / satin glass, white  
Wandleuchte; Stahl, nickel-matt / Glas satiniert, weiss  
applique; acier, nickel mat / verre satiné, blanc

L 600, B 50, A 85

LED

16W

neutral  
WHITE

1500lm



IP44



9 002759 947163

CRI  
>90



A 85

### 94717 CALNOVA

wall light; steel, satin nickel / satin glass, white  
Wandleuchte; Stahl, nickel-matt / Glas satiniert, weiss  
applique; acier, nickel mat / verre satiné, blanc

L 900, B 50, A 85

LED

24W

neutral  
WHITE

2200lm



IP44



9 002759 947170

CRI  
>90



A 85

DESIGN  
HIGHLIGHT  
DETAIL



94616

LED



94617

LED



94618

LED

### 94616 TORRETTA

mirror light; steel, satin nickel / plastic, white  
Spiegelleuchte; Stahl, nickel-matt / Kunststoff, weiss  
applique pour miroir; acier, nickel mat / plastique, blanc

L 350, B 40, A 75



8W



770lm



IP44



9 002759 946166

CRI  
>90



A 75

### 94617 TORRETTA

mirror light; steel, satin nickel / plastic, white  
Spiegelleuchte; Stahl, nickel-matt / Kunststoff, weiss  
applique pour miroir; acier, nickel mat / plastique, blanc

L 600, B 40, A 75



16W



1500lm



IP44



9 002759 946173

CRI  
>90



A 75

### 94618 TORRETTA

mirror light; steel, satin nickel / plastic, white  
Spiegelleuchte; Stahl, nickel-matt / Kunststoff, weiss  
applique pour miroir; acier, nickel mat / plastique, blanc

L 900, B 40, A 75



24W



2200lm



IP44



9 002759 946180

CRI  
>90



A 75



94613

LED





94614

LED



94612

LED

### 94613 TABIANO

mirror light; steel, chrome / plastic, white  
Spiegelleuchte; Stahl, chrom / Kunststoff, weiss  
applique pour miroir; acier, chrome / plastique, blanc

L 605, H 70, A 130



3x 3,2W 900lm

### 94614 TABIANO

mirror light; steel, satin nickel / plastic, white  
Spiegelleuchte; Stahl, nickel-matt / Kunststoff, weiss  
applique pour miroir; acier, nickel mat / plastique, blanc

L 405, H 70, A 130



2x 3,2W 600lm

### 94612 TABIANO

mirror light; steel, chrome / plastic, white  
Spiegelleuchte; Stahl, chrom / Kunststoff, weiss  
applique pour miroir; acier, chrome / plastique, blanc

L 405, H 70, A 130



2x 3,2W 600lm



9 002759 946135

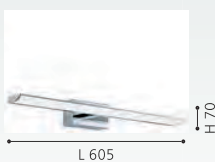

9 002759 946142

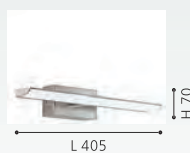

9 002759 946128

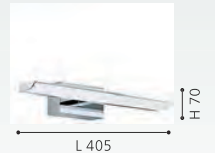

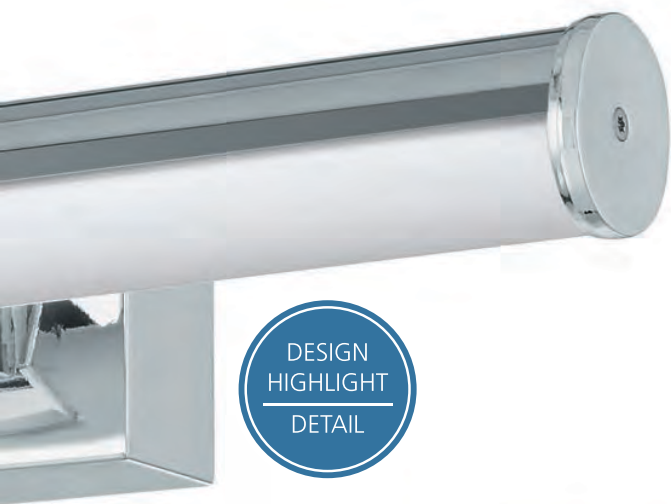

DESIGN  
HIGHLIGHT  
DETAIL



97081

LED



97082

LED

### 97081 VADUMI

wall light; plastic, chrome / plastic, white  
Wandleuchte; Kunststoff, chrom / Kunststoff, weiss  
applique; plastique, chrome / plastique, blanc

L 400, H 50, A 125



7,4W 900lm



9 002759 970819



L 400

H 50

### 97082 VADUMI

wall light; plastic, chrome / plastic, white  
Wandleuchte; Kunststoff, chrom / Kunststoff, weiss  
applique; plastique, chrome / plastique, blanc

L 600, H 50, A 125



11W 1350lm



9 002759 970826



L 600

H 50

### 97083 VADUMI

wall light; plastic, chrome / plastic, white  
Wandleuchte; Kunststoff, chrom / Kunststoff, weiss  
applique; plastique, chrome / plastique, blanc

L 780, H 50, A 125



14W 1700lm



9 002759 970833



L 780

H 50



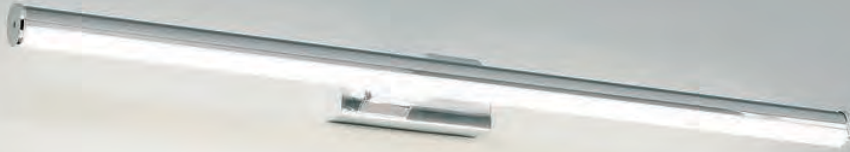

97083

LED





98677

LED

### 98677 PANDELLA 1

mirror light; aluminium, plastic, black / plastic, white  
 Spiegelleuchte; Alu, Kunststoff, schwarz / Kunststoff, weiss  
 applique pour miroir; aluminium, plastique, noir / plastique, blanc

L 780, H 40, A 120

LED

14 W

neutral  
 WHITE

1700lm



IP44



9 002759 986773

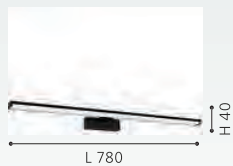

DESIGN  
 HIGHLIGHT  
 ———  
 DETAIL

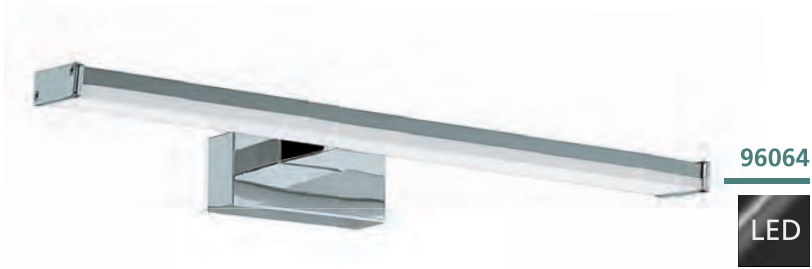

96064

LED

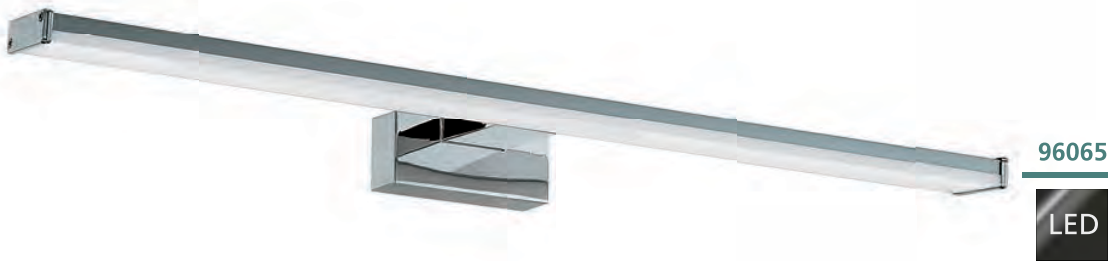

96065

LED



96066

LED

### 96064 PANDELLA 1

mirror light; aluminium, plastic, chrome, silver / plastic, white  
Spiegelleuchte; Alu, Kunststoff, chrom, silber / Kunststoff, weiss  
applique pour miroir; aluminium, plastique, chrome, argent /  
plastique, blanc

L 400, H 40, A 120



7,4W 900lm

### 96065 PANDELLA 1

mirror light; aluminium, plastic, chrome, silver / plastic, white  
Spiegelleuchte; Alu, Kunststoff, chrom, silber / Kunststoff, weiss  
applique pour miroir; aluminium, plastique, chrome, argent /  
plastique, blanc

L 600, H 40, A 120



11W 1350lm

### 96066 PANDELLA 1

mirror light; aluminium, plastic, chrome, silver / plastic, white  
Spiegelleuchte; Alu, Kunststoff, chrom, silber / Kunststoff, weiss  
applique pour miroir; aluminium, plastique, chrome, argent /  
plastique, blanc

L 780, H 40, A 120



14W 1700lm



9 002759 960643



L 400

H 40



9 002759 960650



L 600

H 40



9 002759 960667



L 780

H 40



99297

LED

### 99297 PANDELLA 1

mirror light; aluminium, plastic, chrome, silver / plastic, white  
 Spiegelleuchte; Alu, Kunststoff, chrom, silber / Kunststoff, weiss  
 applique pour miroir; aluminium, plastique, chrome, argent /  
 plastique, blanc

L 1200, H 40, A 120



14W



1700lm



IP44



9 002759 992972



L 1200

H 40

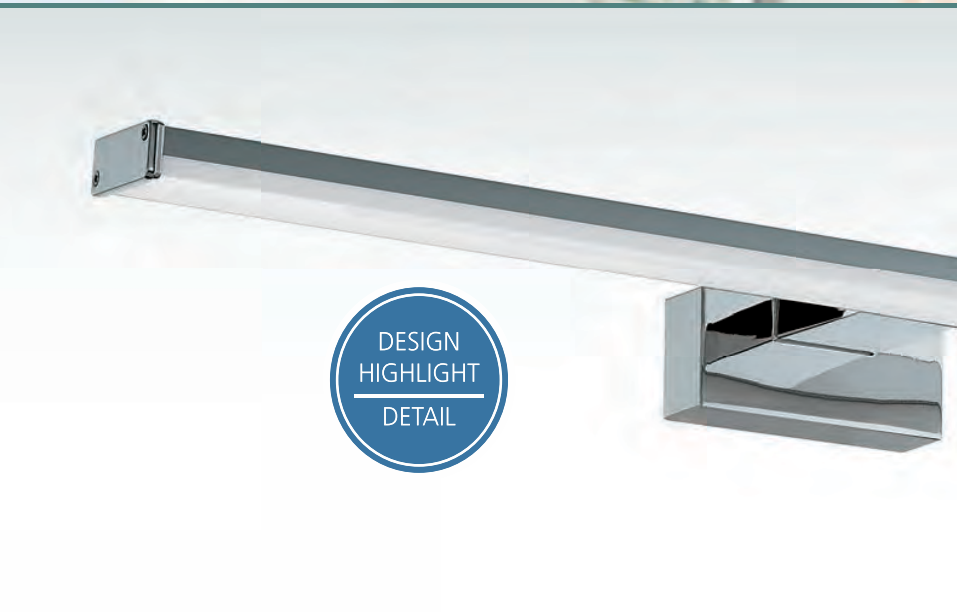

DESIGN  
 HIGHLIGHT  
 DETAIL

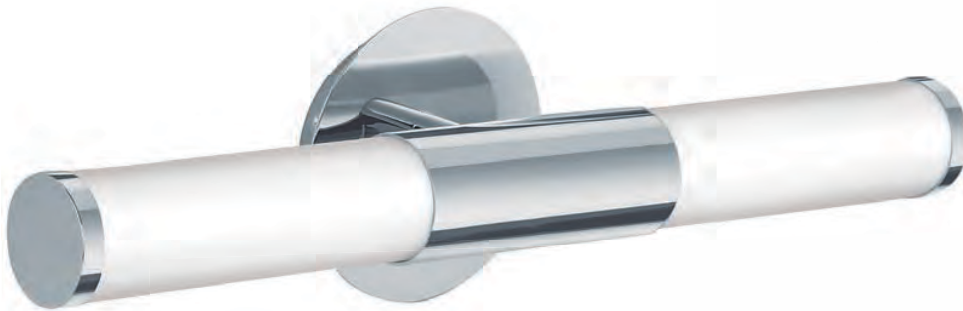

87219

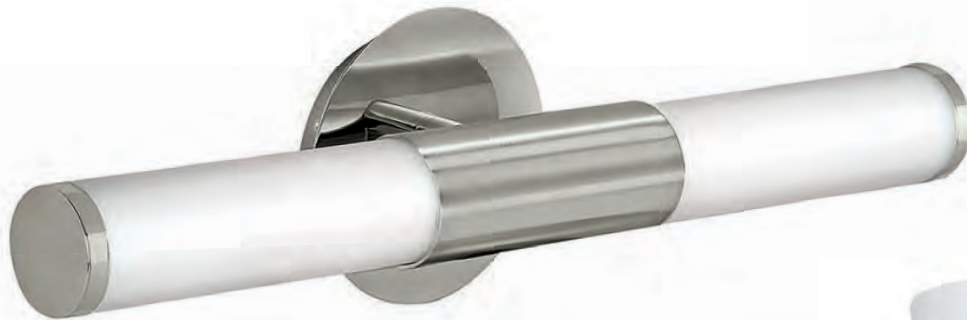

87222



87219 | 87222



94989

LED

### 87219 PALMERA

wall light; steel, chrome / glass opal-matt, white  
Wandleuchte; Stahl, chrom / Glas opal-matt, weiss  
applique; acier, chrome / verre opale mat, blanc

L 460, A 110



E14 2x 40W IP44



9 002759 872199



L 460

### 87222 PALMERA

wall light; steel, satin nickel / glass opal-matt, white  
Wandleuchte; Stahl, nickel-matt / Glas opal-matt, weiss  
applique; acier, nickel mat / verre opale mat, blanc

L 460, A 110



E14 2x 40W IP44



9 002759 872229



L 460

### 94989 CAILIN

wall light; cast aluminium, chrome / satin glass, white  
Wandleuchte; Aluguss, chrom / Glas satiniert, weiss  
applique; fonte d'aluminium, chrome / verre satiné, blanc

L 90, H 270, A 115



G9 2x 3W warm WHITE 2x 360lm IP44



9 002759 949891



A 115

H 270



### 85832 STICKER

mirror light; steel, chrome / glass opal-matt, white  
Spiegelleuchte; Stahl, chrom / Glas opal-matt, weiss  
applique pour miroir; acier, chrome / verre opale mat, blanc

L 70, H 115, A 95



E14



1x 40W



9 002759 858322



A 95

H 115





99772

LED

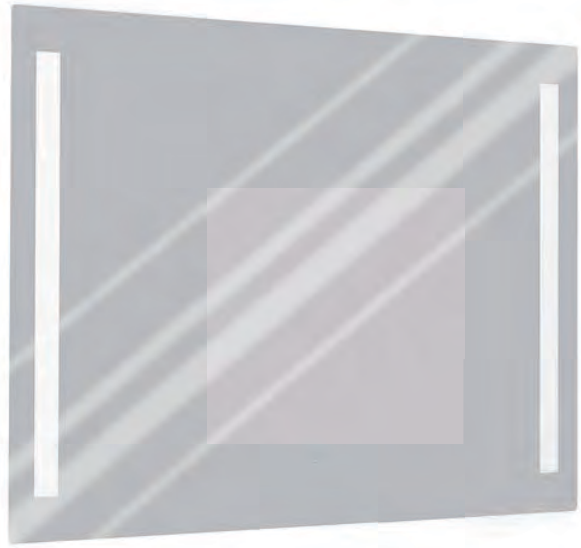

99773

LED

### 99772 BUENAVISTA

mirror light; aluminium, silver / mirror  
Spiegelleuchte; Alu, silber / Spiegel  
applique pour miroir; aluminium, argent / miroir

L 500, H 700, A 30

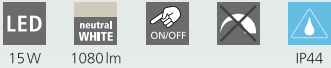

9 002759 997724



### 99773 BUENAVISTA

mirror light; aluminium, silver / mirror  
Spiegelleuchte; Alu, silber / Spiegel  
applique pour miroir; aluminium, argent / miroir

L 800, H 600, A 30

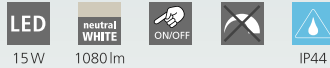

9 002759 997731

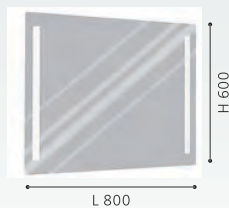

### 99774 BUENAVISTA

mirror light; aluminium, silver / mirror  
Spiegelleuchte; Alu, silber / Spiegel  
applique pour miroir; aluminium, argent / miroir

Ø 600, A 30

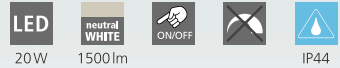

9 002759 997748





99774

LED





99838

LED



99839

LED

### 99838 BUENAVISTA 1

mirror light; aluminium, silver / mirror  
Spiegelleuchte; Alu, silber / Spiegel  
applique pour miroir; aluminium, argent / miroir

L 500, H 700, A 30

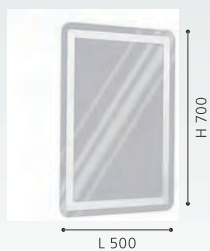
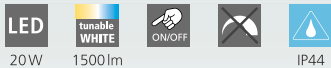

### 99839 BUENAVISTA 1

mirror light; aluminium, silver / mirror  
Spiegelleuchte; Alu, silber / Spiegel  
applique pour miroir; aluminium, argent / miroir

L 800, H 600, A 30

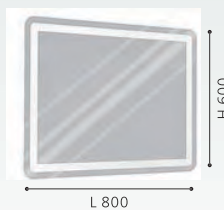
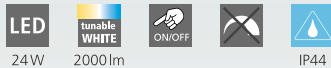

### 99853 BUENAVISTA 2

mirror light; aluminium, silver / mirror  
Spiegelleuchte; Alu, silber / Spiegel  
applique pour miroir; aluminium, argent / miroir

L 500, H 700, A 30

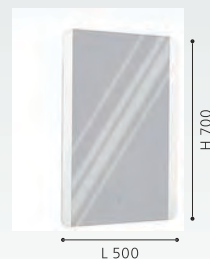
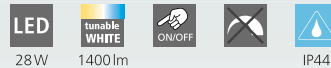



99853

LED



99854

LED

## 99854 BUENAVISTA 2

mirror light; aluminium, silver / mirror  
Spiegelleuchte; Alu, silber / Spiegel  
applique pour miroir; aluminium, argent / miroir

L 800, H 600, A 30

LED

24W

tunable  
WHITE

1200lm

ON/OFF

IP44

IP44



9 002759 998547

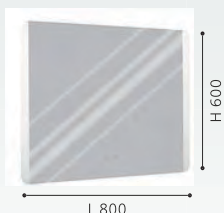

L 800

H 600

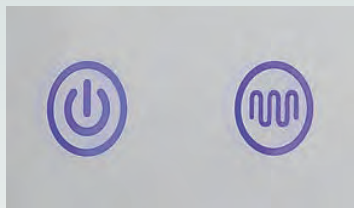

## 99838, 99839, 99853

The additional anti-fog function prevents the mirror from fogging up and ensures a clear view after showering.

Die zusätzliche Anti-Fog-Funktion verhindert das Beschlagen des Spiegels und sorgt für eine klare Sicht nach dem Duschen.

La fonction antibuée supplémentaire empêche le miroir de s'embuer et assure une vue dégagée après la douche.

# SPOT & TRACK LUMINAIRES

SPOT- & SCHIENENLEUCHTEN  
SPOTS & LUMINAIRES SUR RAIL

## SYSTEMATIC LIGHTING -

Our spot & track luminaires set specific highlights while optimally lighting your living rooms. No matter whether you prefer a modern or a traditional look – our range will fit any taste.

## BELEUCHTUNG MIT SYSTEM -

Mit unseren Spot- & Schienenleuchten setzen Sie gezielt Lichtakzente und sorgen zugleich für eine optimale Ausleuchtung Ihrer Wohnräume. Egal ob modern oder traditionell - unser Sortiment trifft jeden Geschmack.

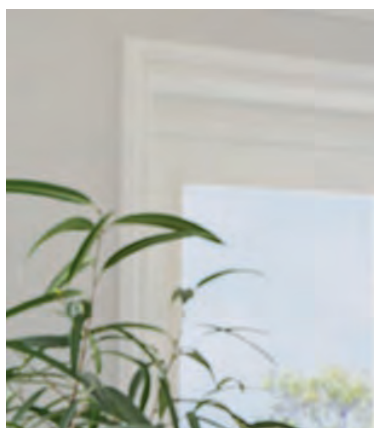

## UN ÉCLAIRAGE AVEC SYSTÈME -

Nos spots et nos luminaires sur rail vous permettent d'offrir des accents ponctuels de lumière et assurent parallèlement un éclairage optimal de vos pièces d'habitat. Qu'ils soient modernes ou traditionnels - notre gamme répond à tous les goûts.







**33169**

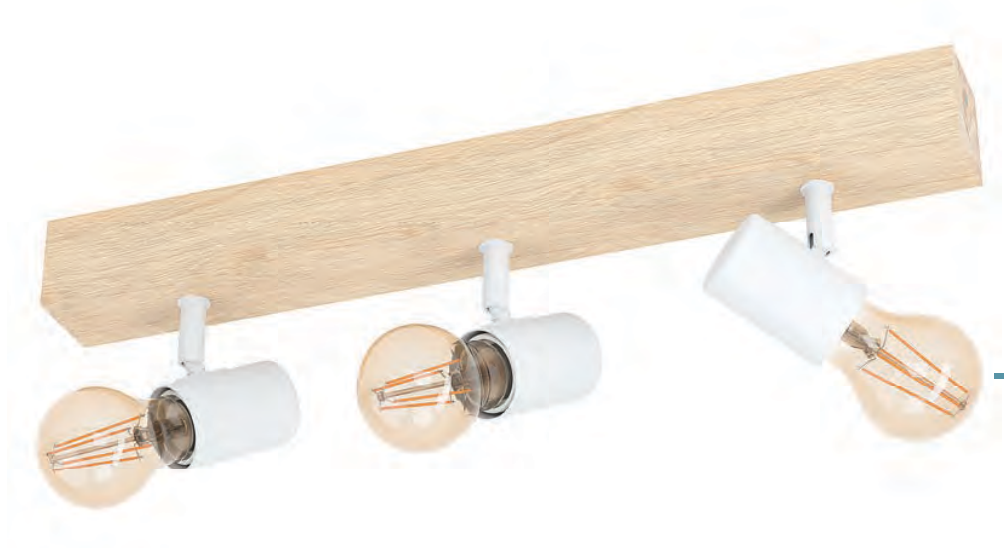

**33171**

**33169 TOWNSHEND 3**

spot; wood, steel, brown, white  
Spot; Holz, Stahl, braun, weiss  
spot; bois, acier, marron, blanc

L 300, B 50



E27 2x 60W



9 002759 331696



L 300

**33171 TOWNSHEND 3**

spot; wood, steel, brown, white  
Spot; Holz, Stahl, braun, weiss  
spot; bois, acier, marron, blanc

L 480, B 50



E27 3x 60W



9 002759 331719



L 480

**33172 TOWNSHEND 3**

spot; wood, steel, brown, white  
Spot; Holz, Stahl, braun, weiss  
spot; bois, acier, marron, blanc

L 630, B 50



E27 4x 60W



9 002759 331726



L 630



33172



33168

### 33168 TOWNSHEND 3

spot; wood, steel, brown, white  
 Spot; Holz, Stahl, braun, weiss  
 spot; bois, acier, marron, blanc

L 165, B 50



E27



1x 10W



9 002759 331689



B 50



98112



98113

### 98112 TOWNSHEND 3

spot; wood, steel, brown, black  
 Spot; Holz, Stahl, braun, schwarz  
 spot; bois, acier, marron, noir

L 300, B 50



E27



2x 60W



9 002759 981129



B 50

L 300

### 98113 TOWNSHEND 3

spot; wood, steel, brown, black  
 Spot; Holz, Stahl, braun, schwarz  
 spot; bois, acier, marron, noir

L 480, B 50



E27



3x 60W



9 002759 981136



B 50

L 480

### 98114 TOWNSHEND 3

spot; wood, steel, brown, black  
 Spot; Holz, Stahl, braun, schwarz  
 spot; bois, acier, marron, noir

L 630, B 50



E27



4x 60W



9 002759 981143



B 50

L 630





98114



98111

### 98111 TOWNSHEND 3

spot; wood, steel, brown, black  
Spot; Holz, Stahl, braun, schwarz  
spot; bois, acier, marron, noir

L 165, B 50



E27



1x 10W



9 002759 981112





**98138**



**98139**



**98142**

**98138 VILLABATE**

spot; steel, satin nickel / fabric, grey  
Spot; Stahl, nickel-matt / Textil, grau  
spot; acier, nickel mat / tissu, gris

Ø 120



E27 1x 10W

**98139 VILLABATE**

spot; steel, satin nickel / fabric, grey  
Spot; Stahl, nickel-matt / Textil, grau  
spot; acier, nickel mat / tissu, gris

L 335, B 90



E27 2x 10W

**98142 VILLABATE**

spot; steel, satin nickel / fabric, grey  
Spot; Stahl, nickel-matt / Textil, grau  
spot; acier, nickel mat / tissu, gris

L 795, B 90



E27 4x 10W



9 002759 981389



9 002759 981396



9 002759 981426



98141

### 98141 VILLABATE

spot; steel, satin nickel / fabric, grey  
Spot; Stahl, nickel-matt / Textil, grau  
spot; acier, nickel mat / tissu, gris

L 575, B 90



E27



3x 10W



L 575

B 90



### 33646 VILLABATE

spot; steel, black / fabric, black, white  
 Spot; Stahl, schwarz / Textil, schwarz, weiss  
 spot; acier, noir / tissu, noir, blanc

L 335, B 90



### 33647 VILLABATE

spot; steel, black / fabric, black, white  
 Spot; Stahl, schwarz / Textil, schwarz, weiss  
 spot; acier, noir / tissu, noir, blanc

L 575, B 90



### 33648 VILLABATE

spot; steel, black / fabric, black, white  
 Spot; Stahl, schwarz / Textil, schwarz, weiss  
 spot; acier, noir / tissu, noir, blanc

L 795, B 90



9 002759 336462



9 002759 336479



9 002759 336486





33645

### 33645 VILLABATE

spot; steel, black / fabric, black, white  
Spot; Stahl, schwarz / Textil, schwarz, weiss  
spot; acier, noir / tissu, noir, blanc

Ø 120



E27



1x 10W



DESIGN  
HIGHLIGHT  
DETAIL

SPOT & TRACK LUMINAIRES



99488



99489



99491



### 99488 BATALLAS

spot; wood, steel, brown, black / fabric, black, white  
Spot; Holz, Stahl, braun, schwarz / Textil, schwarz, weiss  
spot; bois, acier, marron, noir / tissu, noir, blanc

L 100, H 170, A 205



E27



1x 10W

### 99489 BATALLAS

spot; wood, steel, brown, black / fabric, black, white  
Spot; Holz, Stahl, braun, schwarz / Textil, schwarz, weiss  
spot; bois, acier, marron, noir / tissu, noir, blanc

L 300, B 50



E27



2x 10W

### 99491 BATALLAS

spot; wood, steel, brown, black / fabric, black, white  
Spot; Holz, Stahl, braun, schwarz / Textil, schwarz, weiss  
spot; bois, acier, marron, noir / tissu, noir, blanc

L 480, B 50



E27



3x 10W



9 002759 994884



9 002759 994891



9 002759 994914

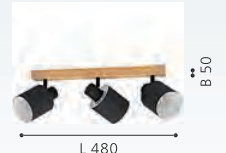



99492



## 99492 BATALLAS

spot; wood, steel, brown, black / fabric, black, white  
Spot; Holz, Stahl, braun, schwarz / Textil, schwarz, weiss  
spot; bois, acier, marron, noir / tissu, noir, blanc

L 630, B 50



E27



4x 10W



9 002759 994921



L 630

B 50

DESIGN  
HIGHLIGHT  
DETAIL



99277

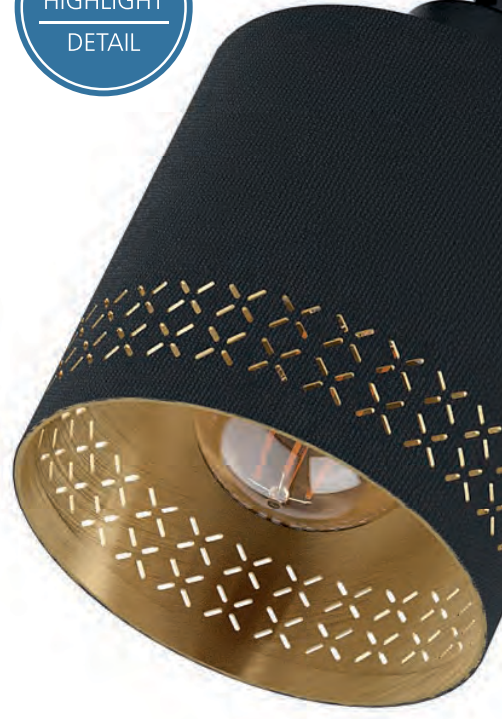

99276

**99278 ESTEPERRA**

spot; steel, black / fabric, black, gold  
Spot; Stahl, schwarz / Textil, schwarz, gold  
spot; acier, noir / tissu, noir, or

L 575, B 90



**99277 ESTEPERRA**

spot; steel, black / fabric, black, gold  
Spot; Stahl, schwarz / Textil, schwarz, gold  
spot; acier, noir / tissu, noir, or

L 335, B 90



**99276 ESTEPERRA**

spot; steel, black / fabric, black, gold  
Spot; Stahl, schwarz / Textil, schwarz, gold  
spot; acier, noir / tissu, noir, or

H 240, Ø 120







97536

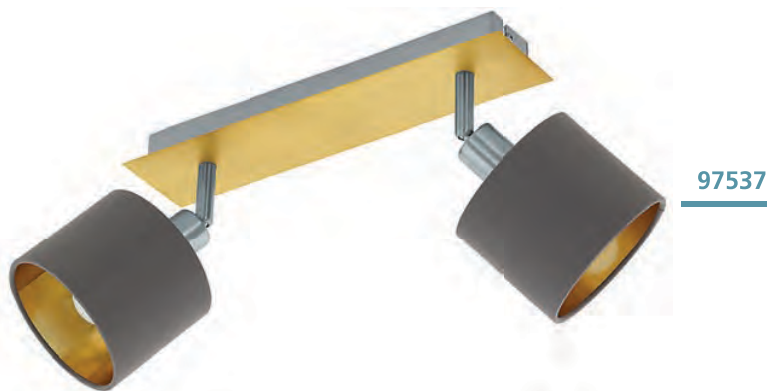

97537



97538

### 97536 VALBIANO

spot; steel, brushed brass, satin nickel / fabric, cappuccino, gold  
Spot; Stahl, messing-gebürstet, nickel-matt / Textil, cappuccino, gold

spot; acier, laiton brossé, nickel mat / tissu, cappuccino, or

L 110, B 110



E14 1x 7W



9 002759 975364



L 110

### 97537 VALBIANO

spot; steel, brushed brass, satin nickel / fabric, cappuccino, gold  
Spot; Stahl, messing-gebürstet, nickel-matt / Textil, cappuccino, gold

spot; acier, laiton brossé, nickel mat / tissu, cappuccino, or

L 320, B 70



E14 2x 7W



9 002759 975371



L 320

### 97538 VALBIANO

spot; steel, brushed brass, satin nickel / fabric, cappuccino, gold  
Spot; Stahl, messing-gebürstet, nickel-matt / Textil, cappuccino, gold

spot; acier, laiton brossé, nickel mat / tissu, cappuccino, or

L 560, B 70

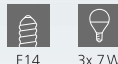

E14 3x 7W



9 002759 975388



L 560



97539

### 97539 VALBIANO

spot; steel, brushed brass, satin nickel / fabric, cappuccino, gold  
Spot; Stahl, messing-gebürstet, nickel-matt / Textil, cappuccino, gold  
spot; acier, laiton brossé, nickel mat / tissu, cappuccino, or

L 780, B 70



E14



4x 7W



9 002759 975395



L 780

B 70





98624



98624 | 98625 | 98626



98625

### 98624 POLLICA

spot; steel, black / glass vaporized, black-transparent  
Spot; Stahl, schwarz / Glas bedampft, schwarz-transparent  
spot; acier, noir / verre vaporisé, noir transparent

L 65, H 105



E14 1x 10W

### 98625 POLLICA

spot; steel, black / glass vaporized, black-transparent  
Spot; Stahl, schwarz / Glas bedampft, schwarz-transparent  
spot; acier, noir / verre vaporisé, noir transparent

L 365, B 165



E14 2x 28W

### 98626 POLLICA

spot; steel, black / glass vaporized, black-transparent  
Spot; Stahl, schwarz / Glas bedampft, schwarz-transparent  
spot; acier, noir / verre vaporisé, noir transparent

L 640, B 220



E14 4x 28W



9 002759 986247



9 002759 986254



9 002759 986261





98626





**99052**



99052 | 99053 | 99054



**99053**

### 99052 BERREGAS

spot; steel, black, chrome / glass vaporized, black-transparent  
 Spot; Stahl, schwarz, chrom / Glas bedampft, schwarz-transparent  
 spot; acier, noir, chrome / verre vaporisé, noir transparent

Ø 110



### 99053 BERREGAS

spot; steel, black, chrome / glass vaporized, black-transparent  
 Spot; Stahl, schwarz, chrom / Glas bedampft, schwarz-transparent  
 spot; acier, noir, chrome / verre vaporisé, noir transparent

L 440, B 110



### 99054 BERREGAS

spot; steel, black, chrome / glass vaporized, black-transparent  
 Spot; Stahl, schwarz, chrom / Glas bedampft, schwarz-transparent  
 spot; acier, noir, chrome / verre vaporisé, noir transparent

L 775, B 110



9 002759 990527



Ø 110



9 002759 990534



L 440

B 110



9 002759 990541

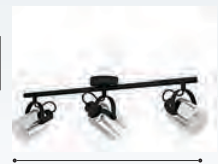

L 775

B 110



99054



99517



99518

### 99517 CASIBARE

spot; steel, black  
Spot; Stahl, schwarz  
spot; acier, noir

L 120, H 185, A 190



E27



1x 28W



9 002759 995171



### 99518 CASIBARE

spot; steel, black  
Spot; Stahl, schwarz  
spot; acier, noir

L 335, H 175, A 180



E27



2x 28W



9 002759 995188



### 99519 CASIBARE

spot; steel, black  
Spot; Stahl, schwarz  
spot; acier, noir

L 575, H 175, A 180



E27



3x 28W



9 002759 995195





99519







99075



99076

### 99075 COSWARTH

spot; steel, wood, anthracite, cream-white, brown  
Spot; Stahl, Holz, anthrazit, creme-weiss, braun  
spot; acier, bois, anthracite, blanc crème, marron

L 480, B 140, H 240



E27

2x 40W

### 99076 COSWARTH

spot; steel, wood, anthracite, cream-white, brown  
Spot; Stahl, Holz, anthrazit, creme-weiss, braun  
spot; acier, bois, anthracite, blanc crème, marron

L 670, B 140, H 240



E27

3x 40W

### 99074 COSWARTH

spot; steel, wood, anthracite, cream-white, brown  
Spot; Stahl, Holz, anthrazit, creme-weiss, braun  
spot; acier, bois, anthracite, blanc crème, marron

L 140, H 200



E27

1x 25W



9 002759 990756



L 480

B 140



9 002759 990763



L 670

B 140



9 002759 990749



L 140

H 200



99074





98621



98623

### 98621 CAROVIGNO

spot; steel, black  
Spot; Stahl, schwarz  
spot; acier, noir

L 65, H 105



E14 1x 28W



9 002759 986216



### 98623 CAROVIGNO

spot; steel, black  
Spot; Stahl, schwarz  
spot; acier, noir

L 640, B 150



E14 4x 40W



9 002759 986230

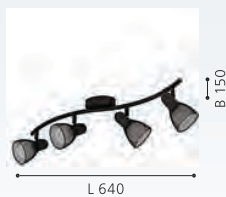

### 98622 CAROVIGNO

spot; steel, black  
Spot; Stahl, schwarz  
spot; acier, noir

L 365, B 150



E14 2x 40W



9 002759 986223





98622

98622



98134



98135



98137

### 98134 SAMBATELLO

spot; wood, steel, brown, silver / steel, silver  
Spot; Holz, Stahl, braun, silber / Stahl, silber  
spot; bois, acier, marron, argent / acier, argent

L 150, H 220, A 240



### 98135 SAMBATELLO

spot; wood, steel, brown, silver / steel, silver  
Spot; Holz, Stahl, braun, silber / Stahl, silber  
spot; bois, acier, marron, argent / acier, argent

L 335, B 90



### 98137 SAMBATELLO

spot; wood, steel, brown, silver / steel, silver  
Spot; Holz, Stahl, braun, silber / Stahl, silber  
spot; bois, acier, marron, argent / acier, argent

L 795, B 90

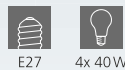

9 002759 981341



9 002759 981358



9 002759 981372





**98136**

### 98136 SAMBATELLO

spot; wood, steel, brown, silver / steel, silver  
Spot; Holz, Stahl, braun, silber / Stahl, silber  
spot; bois, acier, marron, argent / acier, argent

L 575, B 90



E27



3x 40W



9 002759 981365

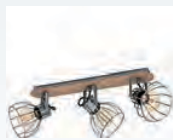

L 575

B 90



98763



98764

### 98763 TABILLANO

spot; steel, black  
Spot; Stahl, schwarz  
spot; acier, noir

L 440, B 110



E27



2x 40W



9 002759 987633



L 440

B 110

### 98764 TABILLANO

spot; steel, black  
Spot; Stahl, schwarz  
spot; acier, noir

L 775, B 110



E27



3x 40W



9 002759 987640



L 775

B 110

### 98762 TABILLANO

spot; steel, black  
Spot; Stahl, schwarz  
spot; acier, noir

Ø 110



E27



1x 40W



9 002759 987626



Ø 110



98762







32765

LED



32767

LED

### 32765 ZAPATA 1

spot; steel, black / glass, amber  
Spot; Stahl, schwarz / Glas, amber  
spot; acier, noir / verre, ambre

Ø 60



G9



1x 3W

warm  
WHITE

1x  
360lm

### 32767 ZAPATA 1

spot; steel, black / glass, amber  
Spot; Stahl, schwarz / Glas, amber  
spot; acier, noir / verre, ambre

L 635, B 65



G9



4x 3W

warm  
WHITE

4x  
360lm

### 32766 ZAPATA 1

spot; steel, black / glass, amber  
Spot; Stahl, schwarz / Glas, amber  
spot; acier, noir / verre, ambre

L 360, B 65



G9



2x 3W

warm  
WHITE

2x  
360lm



9 002759 327651



Ø 60



9 002759 327675



L 635

B 65



9 002759 327668



L 360

B 65



32766

LED



95545

LED



95546

LED



95548

LED

### 95545 ZAPATA

spot; steel, copper / satin glass, white  
Spot; Stahl, kupfer / Glas satiniert, weiss  
spot; acier, cuivre / verre satiné, blanc

Ø 60



G9



1x 3W



1x

360lm

### 95546 ZAPATA

spot; steel, copper / satin glass, white  
Spot; Stahl, kupfer / Glas satiniert, weiss  
spot; acier, cuivre / verre satiné, blanc

L 360, B 65



G9



2x 3W



2x

360lm

### 95548 ZAPATA

spot; steel, copper / satin glass, white  
Spot; Stahl, kupfer / Glas satiniert, weiss  
spot; acier, cuivre / verre satiné, blanc

L 635, B 65



G9



4x 3W



4x

360lm



9 002759 955458



Ø 60



9 002759 955465



B 65



L 360



9 002759 955489



B 65



L 635



95547

LED

### 95547 ZAPATA

spot; steel, copper / satin glass, white  
 Spot; Stahl, kupfer / Glas satiniert, weiss  
 spot; acier, cuivre / verre satiné, blanc

L 515, B 65



G9



3x 3W



3x  
 warm  
 WHITE  
 360lm

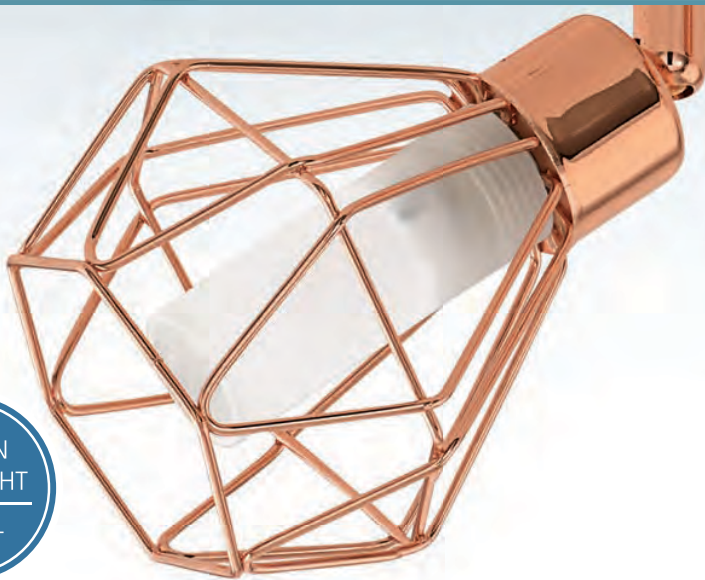



98393

LED



98394

LED



98396

LED

### 98393 SERAS 1

spot; steel, white  
Spot; Stahl, weiss  
spot; acier, blanc

Ø 100

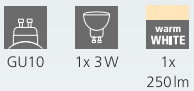

### 98394 SERAS 1

spot; steel, white  
Spot; Stahl, weiss  
spot; acier, blanc

L 370, B 65

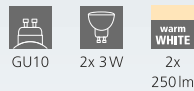

### 98396 SERAS 1

spot; steel, white  
Spot; Stahl, weiss  
spot; acier, blanc

L 770, B 65

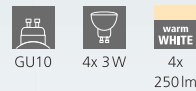

9 002759 983932

Ø 100



9 002759 983949



L 370

B 65



9 002759 983963



L 770

B 65



98395

LED

## 98395 SERAS 1

spot; steel, white  
Spot; Stahl, weiss  
spot; acier, blanc

L 595, B 65



GU10



3x 3W



3x  
warm  
WHITE  
250lm



9 002759 983956





96552

LED



DESIGN  
HIGHLIGHT  
DETAIL



### 96552 SERAS

spot; steel, nickel-antique, creme  
Spot; Stahl, nickel-antik, creme  
spot; acier, nickel-antique, crème

Ø 100



GU10



1x 3W



warm  
WHITE  
1x  
250lm



9 002759 965525



INCL.

Ø 100





96553

LED



96554

LED



96555

LED

### 96553 SERAS

spot; steel, nickel-antique, creme  
Spot; Stahl, nickel-antik, creme  
spot; acier, nickel-antique, crème

L 370, B 65

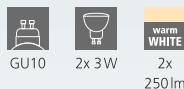

GU10 2x 3W 2x warm WHITE 250lm



9 002759 965532

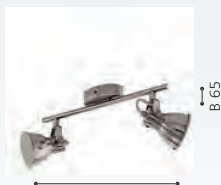

L 370



### 96554 SERAS

spot; steel, nickel-antique, creme  
Spot; Stahl, nickel-antik, creme  
spot; acier, nickel-antique, crème

L 595, B 65

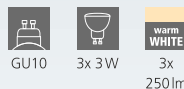

GU10 3x 3W 3x warm WHITE 250lm



9 002759 965549

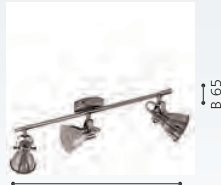

L 595

### 96555 SERAS

spot; steel, nickel-antique, creme  
Spot; Stahl, nickel-antik, creme  
spot; acier, nickel-antique, crème

L 770, B 65

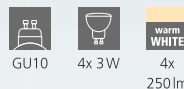

GU10 4x 3W 4x warm WHITE 250lm



9 002759 965556

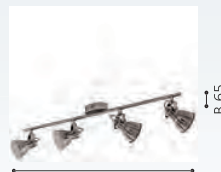

L 770





98398

LED



98397

LED



### 98398 SERAS 2

spot; steel, black  
Spot; Stahl, schwarz  
spot; acier, noir

L 370, B 65



GU10



2x 3W



Warm  
WHITE  
2x  
250lm

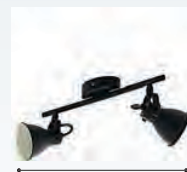

L 370

B 65



98399

LED



98408

LED

### 98397 SERAS 2

spot; steel, black  
Spot; Stahl, schwarz  
spot; acier, noir

Ø 100

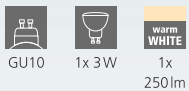

### 98399 SERAS 2

spot; steel, black  
Spot; Stahl, schwarz  
spot; acier, noir

L 595, B 65

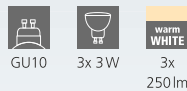

### 98408 SERAS 2

spot; steel, black  
Spot; Stahl, schwarz  
spot; acier, noir

L 770, B 65

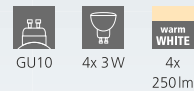

9 002759 983970



Ø 100



9 002759 983994



L 595

B 65



9 002759 984083



L 770

B 65



DESIGN  
HIGHLIGHT  
DETAIL



88472



88475

**88472 DAKAR 1**

spot; steel, satin nickel / glass wiping technique, white  
Spot; Stahl, nickel-matt / Glas Wischtechnik, weiss  
spot; acier, nickel mat / technique d'essuie de verre, blanc

L 105, B 65



E14 1x 25W



9 002759 884727



L 105

**88475 DAKAR 1**

spot; steel, satin nickel / glass wiping technique, white  
Spot; Stahl, nickel-matt / Glas Wischtechnik, weiss  
spot; acier, nickel mat / technique d'essuie de verre, blanc

Ø 295



E14 3x 40W



9 002759 884758



Ø 295

**88474 DAKAR 1**

spot; steel, satin nickel / glass wiping technique, white  
Spot; Stahl, nickel-matt / Glas Wischtechnik, weiss  
spot; acier, nickel mat / technique d'essuie de verre, blanc

L 650, B 100



E14 4x 40W



9 002759 884741



L 650

B 100



88474



88473

### 88473 DAKAR 1

spot; steel, satin nickel / glass wiping technique, white  
Spot; Stahl, nickel-matt / Glas Wischtechnik, weiss  
spot; acier, nickel mat / technique d'essuie de verre, blanc

L 370, B 100



E14



2x 40W



9 002759 884734



L 370

B 100



### 94585 BARNHAM

spot; steel, black, copper  
Spot; Stahl, schwarz, kupfer  
spot; acier, noir, cuivre

L 395, B 70

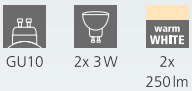

### 94586 BARNHAM

spot; steel, black, copper  
Spot; Stahl, schwarz, kupfer  
spot; acier, noir, cuivre

L 585, B 70

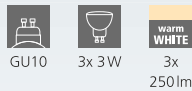

### 94587 BARNHAM

spot; steel, black, copper  
Spot; Stahl, schwarz, kupfer  
spot; acier, noir, cuivre

L 780, B 70

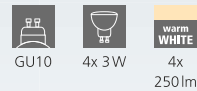



94587

LED



94584

LED

### 94584 BARNHAM

spot; steel, black, copper  
Spot; Stahl, schwarz, kupfer  
spot; acier, noir, cuivre

L 165, B 70



GU10



1x 3W



1x  
warm  
WHITE  
250lm



9 002759 945848



B 70

L 165



95483

LED



95482

LED





95485

LED

**95482 NOCITO**

spot; steel, black, gold  
Spot; Stahl, schwarz, gold  
spot; acier, noir, or



Ø 110

-  GU10
-  1x 3W
-  warm WHITE  
1x  
250lm

**95483 NOCITO**

spot; steel, black, gold  
Spot; Stahl, schwarz, gold  
spot; acier, noir, or



L 360, B 105

-  GU10
-  2x 3W
-  warm WHITE  
2x  
250lm

**95485 NOCITO**

spot; steel, black, gold  
Spot; Stahl, schwarz, gold  
spot; acier, noir, or

L 760, B 105

-  GU10
-  4x 3W
-  warm WHITE  
4x  
250lm



9 002759 954826



9 002759 954833



9 002759 954857





95484

LED

### 95484 NOCITO

spot; steel, black, gold  
Spot; Stahl, schwarz, gold  
spot; acier, noir, or

L 585, B 105



GU10



3x 3W



warm  
WHITE  
3x  
250lm



9 002759 954840



DESIGN  
HIGHLIGHT  
DETAIL





31001

LED



31003

LED



31004

LED

### 31001 BIMEDA

spot; steel, white, chrome  
Spot; Stahl, weiss, chrom  
spot; acier, blanc, chrome

Ø 70



GU10



1x 3W



1x  
240lm

### 31003 BIMEDA

spot; steel, white, chrome  
Spot; Stahl, weiss, chrom  
spot; acier, blanc, chrome

L 290, H 345



GU10



3x 3W



3x  
240lm

### 31004 BIMEDA

spot; steel, white, chrome  
Spot; Stahl, weiss, chrom  
spot; acier, blanc, chrome

L 640, B 100



GU10



4x 3W



4x  
240lm



9 002759 310011



9 002759 310035



9 002759 310042

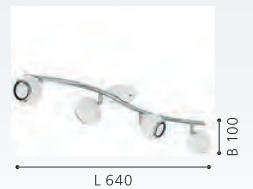



31002

LED

### 31002 BIMEDA

spot; steel, white, chrome

Spot; Stahl, weiss, chrom

spot; acier, blanc, chrome

L 365



GU10



2x 3W



warm  
WHITE  
2x  
240lm



9 002759 310028



INCL.

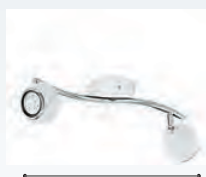

L 365



31005

LED



DESIGN  
HIGHLIGHT  
DETAIL

### 31005 BIMEDA

spot; steel, nickel-nero, chrome  
Spot; Stahl, nickel-nero, chrom  
spot; acier, nickel nero, chrome

Ø 70



GU10



1x 3W



1x  
warm  
WHITE  
240lm



9 002759 310059



INCL.



Ø 70



31008

LED



31007

LED



31006

LED

### 31006 BIMEDA

spot; steel, nickel-nero, chrome  
Spot; Stahl, nickel-nero, chrom  
spot; acier, nickel nero, chrome

L 365



GU10



2x 3W



2x  
warm  
WHITE  
240lm

### 31007 BIMEDA

spot; steel, nickel-nero, chrome  
Spot; Stahl, nickel-nero, chrom  
spot; acier, nickel nero, chrome

L 290, H 345



GU10



3x 3W



3x  
warm  
WHITE  
240lm

### 31008 BIMEDA

spot; steel, nickel-nero, chrome  
Spot; Stahl, nickel-nero, chrom  
spot; acier, nickel nero, chrome

L 640, B 100



GU10



4x 3W



4x  
warm  
WHITE  
240lm



9 002759 310066



L 365



9 002759 310073



L 290

H 345



9 002759 310080



L 640

B 100

DESIGN  
HIGHLIGHT  
DETAIL



94251

LED

### 94251 LOCANDA

ceiling light; steel, satin nickel, chrome  
Deckenleuchte; Stahl, nickel-matt, chrom  
plafonnier; acier, nickel mat, chrome

L 700, B 660



GU10



5x 3W



warm  
WHITE  
5x  
240lm



9 002759 942519



L 700

B 660

### 94252 LOCANDA

ceiling light; steel, white, chrome  
Deckenleuchte; Stahl, weiss, chrom  
plafonnier; acier, blanc, chrome

L 700, B 660



GU10



5x 3W



warm  
WHITE  
5x  
240lm



9 002759 942526



L 700

B 660



92084

LED

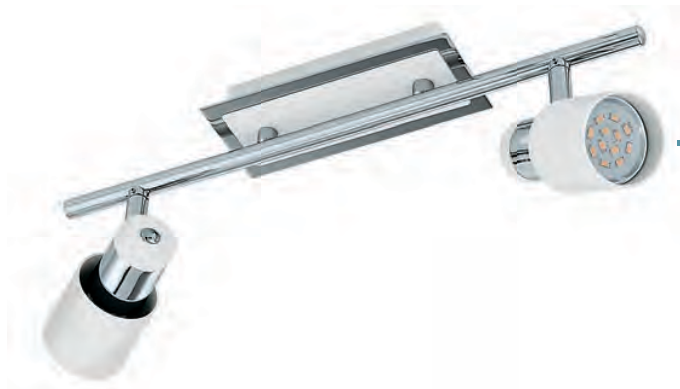

92085

LED



92086

LED

### 92084 DAVIDA

spot; steel, chrome, white  
Spot; Stahl, chrom, weiss  
spot; acier, chrome, blanc

L 165, B 70



9 002759 920845



### 92085 DAVIDA

spot; steel, chrome, white  
Spot; Stahl, chrom, weiss  
spot; acier, chrome, blanc

L 390, B 70

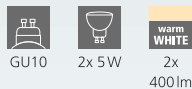

9 002759 920852



### 92086 DAVIDA

spot; steel, chrome, white  
Spot; Stahl, chrom, weiss  
spot; acier, chrome, blanc

L 580, B 70



9 002759 920869





92087

92087

LED

## 92087 DAVIDA

spot; steel, chrome, white  
Spot; Stahl, chrom, weiss  
spot; acier, chrome, blanc

L 780, B 70



GU10



4x 5W



warm  
WHITE

4x

400lm



9 002759 920876



L 780

B 70





30833

LED



30832

LED

### 30832 DAVIDA 1

spot; steel, nickel-nero  
Spot; Stahl, nickel-nero  
spot; acier, nickel noir

L 165, B 70



GU10



1x 5W



warm  
WHITE

1x

400lm



9 002759 308322



INCL.



B 70





30834

LED



30835

LED

### 30833 DAVIDA 1

spot; steel, nickel-nero  
Spot; Stahl, nickel-nero  
spot; acier, nickel noir

L 390, B 70



GU10 2x 5W warm WHITE 2x 400lm



9 002759 308339



L 390

### 30834 DAVIDA 1

spot; steel, nickel-nero  
Spot; Stahl, nickel-nero  
spot; acier, nickel noir

L 580, B 70

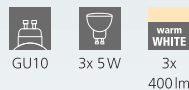

GU10 3x 5W warm WHITE 3x 400lm



9 002759 308346



L 580

### 30835 DAVIDA 1

spot; steel, nickel-nero  
Spot; Stahl, nickel-nero  
spot; acier, nickel noir

L 780, B 70

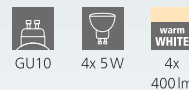

GU10 4x 5W warm WHITE 4x 400lm



9 002759 308353



L 780



94962

LED



94958

LED

### 94962 SARRIA

spot; steel, white, chrome  
Spot; Stahl, weiss, chrom  
spot; acier, blanc, chrome

L 240, H 260



GU10



4x 4,5W



4x  
warm  
WHITE  
345 lm



9 002759 949624



INCL.



L 240

H 260



94959

LED



94961

LED

### 94958 SARRIA

spot; steel, white, chrome  
Spot; Stahl, weiss, chrom  
spot; acier, blanc, chrome

L 120, B 60

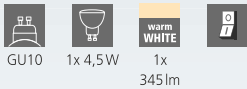

GU10 1x 4,5W 1x 345lm



9 002759 949587



B 60

### 94959 SARRIA

spot; steel, white, chrome  
Spot; Stahl, weiss, chrom  
spot; acier, blanc, chrome

L 300, B 70



GU10 2x 4,5W 2x 345lm



9 002759 949594



L 300

### 94961 SARRIA

spot; steel, white, chrome  
Spot; Stahl, weiss, chrom  
spot; acier, blanc, chrome

L 460, B 70

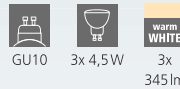

GU10 3x 4,5W 3x 345lm



9 002759 949617



L 460



94963

LED



94966

LED



94964

LED

### 94963 SARRIA

spot; steel, black, chrome  
Spot; Stahl, schwarz, chrom  
spot; acier, noir, chrome

L 120, B 60



9 002759 949631



### 94964 SARRIA

spot; steel, black, chrome  
Spot; Stahl, schwarz, chrom  
spot; acier, noir, chrome

L 300, B 70

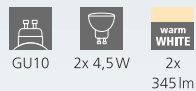

9 002759 949648



### 94966 SARRIA

spot; steel, black, chrome  
Spot; Stahl, schwarz, chrom  
spot; acier, noir, chrome

L 240, H 260

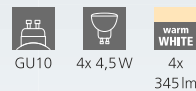

9 002759 949662





94965

LED

**94965 SARRIA**

spot; steel, black, chrome  
 Spot; Stahl, schwarz, chrom  
 spot; acier, noir, chrome

L 460, B 70



GU10



3x 4,5W



warm  
WHITE

3x  
345 lm



9 002759 949655



L 460

B 70



DESIGN  
HIGHLIGHT  
DETAIL



93672

LED



93673

LED

### CORBERA

Designer spot series with special spot heads.

Spotserie mit Spotköpfen in besonderem Design.

Série de spot avec des têtes de spot spéciales.

#### 93672 CORBERA

spot; steel, plastic, chrome  
Spot; Stahl, Kunststoff, chrom  
spot; acier, plastique, chrome

L 120, B 60



#### 93673 CORBERA

spot; steel, plastic, chrome  
Spot; Stahl, Kunststoff, chrom  
spot; acier, plastique, chrome

L 390, B 70

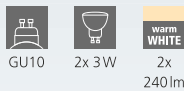

#### 93674 CORBERA

spot; steel, plastic, chrome  
Spot; Stahl, Kunststoff, chrom  
spot; acier, plastique, chrome

L 585, B 70

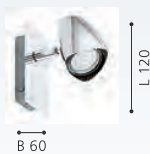
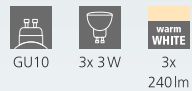



93674

LED

DESIGN  
HIGHLIGHT  
DETAIL

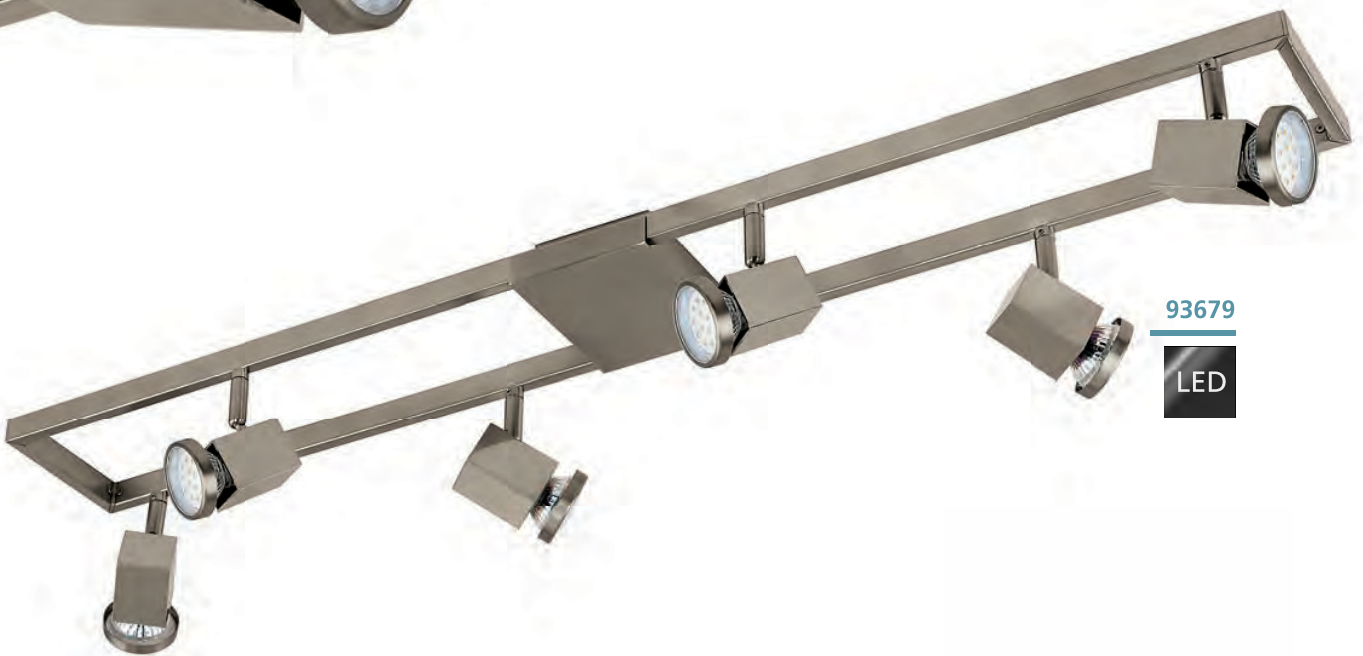

93679

LED

### 93679 ZERACO

spot; steel, plastic, satin nickel  
Spot; Stahl, Kunststoff, nickel-matt  
spot; acier, plastique, nickel mat

L 940, B 120



GU10



6x 5W



warm  
WHITE  
6x  
400lm



9 002759 936792



L 940

B 120

### 93678 ZERACO

spot; steel, plastic, satin nickel  
Spot; Stahl, Kunststoff, nickel-matt  
spot; acier, plastique, nickel mat

L 700, B 120



GU10



4x 5W



warm  
WHITE  
4x  
400lm



9 002759 936785



L 700

B 120



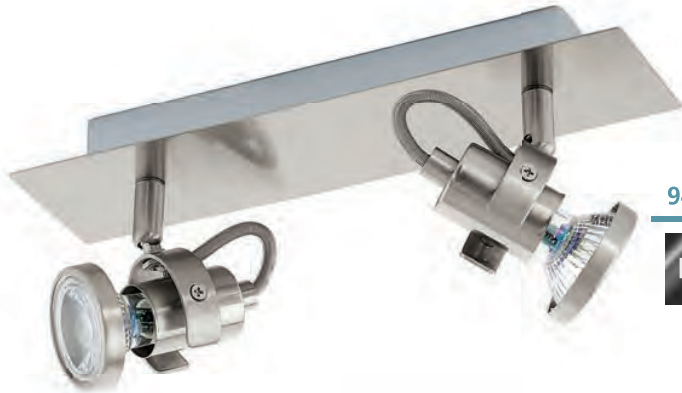

94145

LED



94146

LED

**94145 TUKON 3**

spot; steel, satin nickel  
Spot; Stahl, nickel-matt  
spot; acier, nickel mat

L 280, B 70

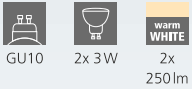

GU10 2x 3W 2x 250lm



9 002759 941451



L 280

**94146 TUKON 3**

spot; steel, satin nickel  
Spot; Stahl, nickel-matt  
spot; acier, nickel mat

L 460, B 70

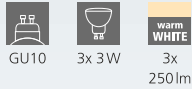

GU10 3x 3W 3x 250lm



9 002759 941468

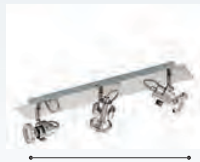

L 460

**94144 TUKON 3**

spot; steel, satin nickel  
Spot; Stahl, nickel-matt  
spot; acier, nickel mat

L 165, B 70

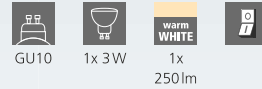

GU10 1x 3W 1x 250lm



9 002759 941444

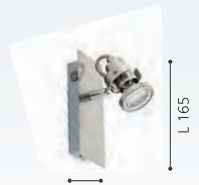

B 70



94144

LED



### 90915 ROTTELO

spot; steel, satin nickel, chrome  
Spot; Stahl, nickel-matt, chrom  
spot; acier, nickel mat, chrome

L 280, B 70

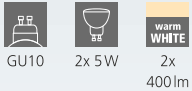

### 90914 ROTTELO

spot; steel, satin nickel, chrome  
Spot; Stahl, nickel-matt, chrom  
spot; acier, nickel mat, chrome

L 120, B 60



### 90916 ROTTELO

spot; steel, satin nickel, chrome  
Spot; Stahl, nickel-matt, chrom  
spot; acier, nickel mat, chrome

L 260, B 240

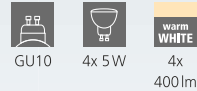



90917

LED



90927

LED

### 90917 ROTTELO

spot; steel, satin nickel, chrome  
Spot; Stahl, nickel-matt, chrom  
spot; acier, nickel mat, chrome

L 780, B 70

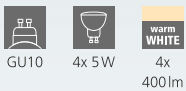

GU10 4x 5W  
warm WHITE  
4x  
400lm

### 90927 ROTTELO

spot; steel, satin nickel, chrome  
Spot; Stahl, nickel-matt, chrom  
spot; acier, nickel mat, chrome

L 1160, B 70

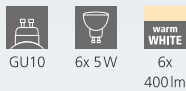

GU10 6x 5W  
warm WHITE  
6x  
400lm



9 002759 909178



L 780

B 70



9 002759 909277

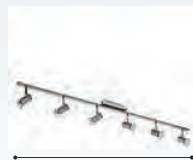

L 1160

B 70



92599

LED

**92599 BUZZ-LED**

spot; steel, satin nickel  
Spot; Stahl, nickel-matt  
spot; acier, nickel mat

L 1050, B 65

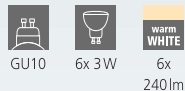

GU10 6x 3W 6x 240lm



9 002759 925994



L 1050

B 65

**92595 BUZZ-LED**

spot; steel, satin nickel  
Spot; Stahl, nickel-matt  
spot; acier, nickel mat

Ø 60

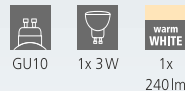

GU10 1x 3W 1x 240lm



9 002759 925956



Ø 60

**92596 BUZZ-LED**

spot; steel, satin nickel  
Spot; Stahl, nickel-matt  
spot; acier, nickel mat

L 285, B 65

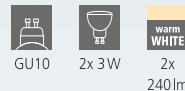

GU10 2x 3W 2x 240lm



9 002759 925963



L 285

B 65



92595

LED



92596

LED



92597

LED



92598

LED

### 92597 BUZZ-LED

spot; steel, satin nickel  
Spot; Stahl, nickel-matt  
spot; acier, nickel mat

L 485, B 65



GU10



3x 3W



3x  
240lm

### 92598 BUZZ-LED

spot; steel, satin nickel  
Spot; Stahl, nickel-matt  
spot; acier, nickel mat

L 685, B 65



GU10



4x 3W



4x  
240lm



9 002759 925970



L 485

B 65



9 002759 925987



L 685

B 65



92641

LED



92642

LED



92643

LED

### 92641 MAGNUM-LED

spot; steel, satin nickel, chrome  
Spot; Stahl, nickel-matt, chrom  
spot; acier, nickel mat, chrome

Ø 70



GU10



1x 3W



1x  
warm  
WHITE  
240lm



9 002759 926410



Ø 70

### 92642 MAGNUM-LED

spot; steel, satin nickel, chrome  
Spot; Stahl, nickel-matt, chrom  
spot; acier, nickel mat, chrome

L 330, B 105



GU10



2x 3W



2x  
warm  
WHITE  
240lm



9 002759 926427



L 330

B 105

### 92643 MAGNUM-LED

spot; steel, satin nickel, chrome  
Spot; Stahl, nickel-matt, chrom  
spot; acier, nickel mat, chrome

L 255, H 295



GU10



3x 3W



3x  
warm  
WHITE  
240lm



9 002759 926434



L 255

H 295



95824

LED



92644

LED



92645

LED

### 95824 MAGNUM LED

spot; steel, satin nickel, chrome  
Spot; Stahl, nickel-matt, chrom  
spot; acier, nickel mat, chrome

Ø 180



GU10



3x 3W



warm  
WHITE

3x

240lm



9 002759 958244



Ø 180

### 92644 MAGNUM-LED

spot; steel, satin nickel, chrome  
Spot; Stahl, nickel-matt, chrom  
spot; acier, nickel mat, chrome

L 645, B 105



GU10



4x 3W



warm  
WHITE

4x

240lm



9 002759 926441

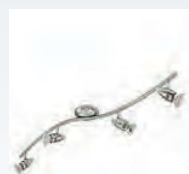

L 645

B 105

### 92645 MAGNUM-LED

spot; steel, satin nickel, chrome  
Spot; Stahl, nickel-matt, chrom  
spot; acier, nickel mat, chrome

L 1050



GU10



6x 3W



warm  
WHITE

6x

240lm



9 002759 926458



L 1050





95629

LED

DESIGN  
HIGHLIGHT  
DETAIL



### 95629 SALTO

spot; steel, chrome / plastic, satiné  
Spot; Stahl, chrom / Kunststoff, satiniert  
spot; acier, chrome / plastique, satiné

L 360, B 120





95628

LED



95631

LED



95632

LED

### 95628 SALTO

spot; steel, chrome / plastic, satiné  
Spot; Stahl, chrom / Kunststoff, satiniert  
spot; acier, chrome / plastique, satiné

Ø 110



1x 5,4W

1x  
640lm

### 95631 SALTO

spot; steel, chrome / plastic, satiné  
Spot; Stahl, chrom / Kunststoff, satiniert  
spot; acier, chrome / plastique, satiné

L 560, B 130



3x 5,4W

3x  
640lm

### 95632 SALTO

spot; steel, chrome / plastic, satiné  
Spot; Stahl, chrom / Kunststoff, satiniert  
spot; acier, chrome / plastique, satiné

L 760, B 130



4x 5,4W

4x  
640lm



9 002759 956288



Ø 110



9 002759 956318



L 560

B 130



9 002759 956325



L 760

B 130

# CLIP & PLUG LUMINAIRES

KLEMM- & STECKERLEUCHTEN  
LUMINAIRES À PINCE & SUR PRISE

## LIGHT - VIRTUALLY ANYWHERE -

Our clamping and plug-in luminaires inspire with their flexible uses. They serve as pleasant reading lamps or can be positioned for targeted highlighting.

## LICHT - PRAKTISCH ÜBERALL -

Unsere Klemm- und Steckerleuchten begeistern durch ihre flexible Verwendbarkeit. Sie dienen als angenehme Lesebeleuchtung oder können zur gezielten Lichtsetzung positioniert werden.



## LA LUMIÈRE - PRATIQUE ET PARTOUT -

Nos luminaires à pinces et à fiches ravissent de leurs possibilités flexibles d'utilisation. Ils servent de lumière agréable pour la lecture ou peuvent être positionnés afin d'offrir une lumière ciblée.



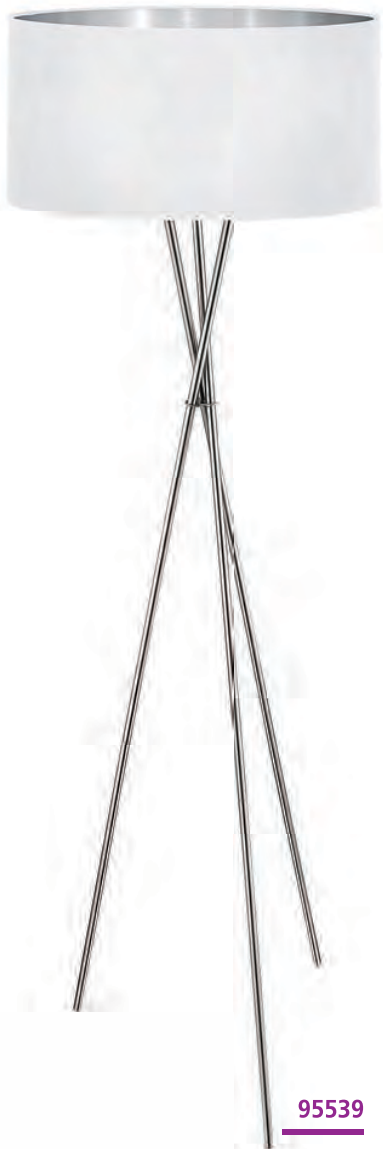

95539



95541



98391

### 95539 FONDACHELLI

floor light; steel, satin nickel / fabric, white, silver  
 Stehleuchte; Stahl, nickel-matt / Textil, weiss, silber  
 lampadaire; acier, nickel mat / tissu, blanc, argent

H 1515, Ø 510

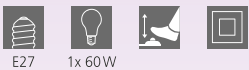

9 002759 955397

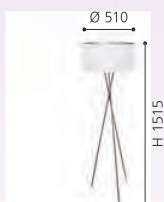

9 002759 955410

H 1515, Ø 510

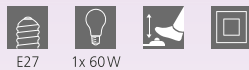

9 002759 983918

H 1440, Ø 340, Base: Ø 645





99015

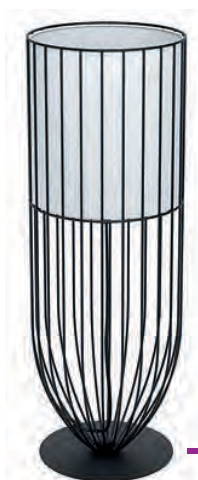

99101



99102

### 99015 ESTAZIONA

floor light; steel, black / fabric, black  
Stehleuchte; Stahl, schwarz / Textil, schwarz  
lampadaire; acier, noir / tissu, noir

L 260, B 235, H 1500, Base: Ø 245



E27 1x 40W



9 002759 990152

### 99101 NOSINO

table light; steel, black / fabric, white  
Tischleuchte; Stahl, schwarz / Textil, weiss  
luminaire de table; acier, noir / tissu, blanc

H 580, Ø 220, Base: Ø 220



E27 1x 60W



9 002759 991012

### 99102 NOSINO

floor light; steel, black / fabric, white  
Stehleuchte; Stahl, schwarz / Textil, weiss  
lampadaire; acier, noir / tissu, blanc

H 1310, Ø 250, Base: Ø 250



E27 1x 60W



9 002759 991029



95686



94946

LED

### 95686 CONESA

floor light; steel, satin nickel / fabric, glass, white  
 Stehleuchte; Stahl, nickel-matt / Textil, Glas, weiss  
 lampadaire; acier, nickel mat / tissu, verre, blanc

H 1700, Ø 380, Base: Ø 230



E27



1x 60W



E14



1x 40W



9 002759 956868



## 98309

This luminaire can be switched separately with a pull switch.

Diese Leuchte ist separat mit Zugschalter schaltbar.

Ce luminaire peut être commuté séparément à l'aide d'un interrupteur à tirette.



98309

LED



92206

## 94946 SANTANDER

floor light; steel, satin nickel / fabric, white  
Stehleuchte; Stahl, nickel-matt / Textil, weiss  
lampadaire; acier, nickel mat / tissu, blanc

H 1530, Ø 500, Base: Ø 250



E27



1x 60W



1x 2,1W



1x 250lm



Ø 250



9 002759 949464

## 98309 ESPARTAL

floor light; steel, aluminium, satin nickel, aluminium / fabric, white  
Stehleuchte; Stahl, Alu, nickel-matt, alu / Textil, weiss  
lampadaire; acier, aluminium, nickel mat, aluminium / tissu, blanc

H 1485, Ø 250, Base: Ø 250



E27



1x 60W



11,8W



1550lm



Ø 250



9 002759 983093

## 92206 NADINA

floor light; steel, satin nickel / fabric with hoop-and-loop tape, white  
Stehleuchte; Stahl, nickel-matt / Textil mit Klettverschluss, weiss  
lampadaire; acier, nickel mat / tissu avec fermeture velcro, blanc

L 1790, B 380, H 1950, Base: Ø 320



E27



1x 60W



Ø 320



9 002759 922061





**98453**

98453



**98674**



**99715**



**98453 TERRIENTE**

floor light; steel, black / glass vaporized, black-transparent  
 Stehleuchte; Stahl, schwarz / Glas bedampft, schwarz-transparent  
 lampadaire; acier, noir / verre vaporisé, noir transparent

H 1500, Base: Ø 260

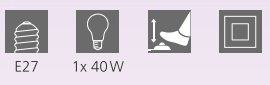

9 002759 984533



H 1500

Ø 260

**98674 REKALDE**

floor light; steel, black, white  
 Stehleuchte; Stahl, schwarz, weiss  
 lampadaire; acier, noir, blanc

L 290, B 160, H 1500, Base: Ø 250



9 002759 986742

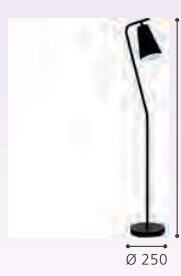

H 1500

Ø 250

**99715 PICACHA**

floor light; steel, black / plastic, white  
 Stehleuchte; Stahl, schwarz / Kunststoff, weiss  
 lampadaire; acier, noir / plastique, blanc

H 1625, Base: B 150, T 150



9 002759 997151



H 1625

B 150



97583

LED



97584

LED

98458

### 97583 BARBOTTO

table light; steel, black, gold  
Tischleuchte; Stahl, schwarz, gold  
luminaire de table; acier, noir, or

H 395, Ø 60, Base: Ø 100



GU10 1x 4,5W 1x 345lm



9 002759 975838



### 97584 BARBOTTO

floor light; steel, black, gold  
Stehleuchte; Stahl, schwarz, gold  
lampadaire; acier, noir, or

H 1370, Ø 60, Base: Ø 185



GU10 1x 4,5W 1x 345lm



9 002759 975845



### 98458 DARNIUS

floor light; steel, black, gold  
Stehleuchte; Stahl, schwarz, gold  
lampadaire; acier, noir, or

H 1420, Ø 380, Base: Ø 645



E27 1x 40W



9 002759 984588



94705



94698



**94698 BORGILLIO**

floor light; steel, black  
Stehleuchte; Stahl, schwarz  
lampadaire, acier, noir

L 380, H 1900, Base: Ø 340



E27



1x 60W



**94705 BORGILLIO**

floor light; steel, copper  
Stehleuchte; Stahl, kupfer  
lampadaire, acier, cuivre

L 380, H 1900, Base: Ø 340



E27



1x 60W



9 002759 946982

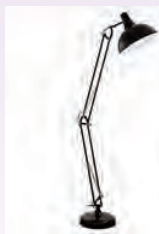

H 1900

Ø 340



9 002759 947057

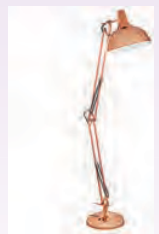

H 1900

Ø 340



**93917**

### 93917 UP 2

floor light; steel, nickel-nero / plastic, glass, white  
 Stehleuchte; Stahl, nickel-nero / Kunststoff, Glas, weiss  
 lampadaire; acier, nickel noir / plastique, verre, blanc

H 1765, Ø 275, Base: Ø 230

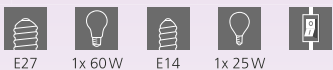

9 002759 939175



**82842**

### 82842 UP 2

floor light; steel, satin nickel / plastic, glass, white  
 Stehleuchte; Stahl, nickel-matt / Kunststoff, Glas, weiss  
 lampadaire; acier, nickel mat / plastique, verre, blanc

H 1765, Ø 275, Base: Ø 230



9 002759 828424



**82843**

### 82843 UP 2

floor light; steel, brass-matt / plastic, glass, white  
 Stehleuchte; Stahl, messing-matt / Kunststoff, Glas, weiss  
 lampadaire; acier, laiton mat / plastique, verre, blanc

H 1765, Ø 275, Base: Ø 230

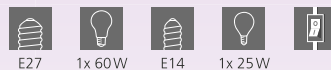

9 002759 828431



82844



DESIGN  
HIGHLIGHT  
DETAIL

### 82844 UP 2

floor light; steel, bronzed / plastic, glass, white  
Stehleuchte; Stahl, brüniert / Kunststoff, Glas, weiss  
lampadaire; acier, bruni / plastique, verre, blanc

H 1765, Ø 275, Base: Ø 230



E27



1x 60W



E14



1x 25W



9 002759 828448





99103

DESIGN  
HIGHLIGHT  
DETAIL



### 99103 VILLABATE 1

table light; steel, black / fabric, black, white  
Tischleuchte; Stahl, schwarz / Textil, schwarz, weiss  
luminaire de table; acier, noir / tissu, noir, blanc

L 185, B 160, H 175



E27



1x 40W



9 002759 991036



H 175

B 160



**99104**

### 99104 VILLABATE 1

table light; steel, satin nickel / fabric, taupe  
Tischleuchte; Stahl, nickel-matt / Textil, taupe  
luminaire de table; acier, nickel mat / tissu, taupe

L 185, B 160, H 175



E27 1x 40W



9 002759 991043

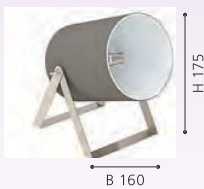

H 175

B 160



**95726**

### 95726 PASTERI

table light; steel, satin nickel / fabric, taupe  
Tischleuchte; Stahl, nickel-matt / Textil, taupe  
luminaire de table; acier, nickel mat / tissu, taupe

H 275, Ø 140, Base: Ø 120



E14 1x 40W



9 002759 957261



H 275

Ø 120



**95725**

### 95725 PASTERI

table light; steel, satin nickel / fabric, white  
Tischleuchte; Stahl, nickel-matt / Textil, weiss  
luminaire de table; acier, nickel mat / tissu, blanc

H 275, Ø 140, Base: Ø 120



E14 1x 40W



9 002759 957254



H 275

Ø 120



95185

### 95185 PEDREGAL 1

table light; steel, copper / fabric, black, copper  
Tischleuchte; Stahl, kupfer / Textil, schwarz, kupfer  
luminaire de table; acier, cuivre / tissu, noir, cuivre

H 645, Ø 350



E27



1x 60W







95789



95787



95788

### 95789 CARLTON 2

table light; steel, black / fabric, white  
Tischleuchte; Stahl, schwarz / Textil, weiss  
luminaire de table; acier, noir / tissu, blanc

H 305, Ø 165



E14 1x 60W



9 002759 957896

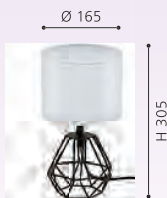

### 95787 CARLTON 2

table light; steel, copper / fabric, black, copper  
Tischleuchte; Stahl, kupfer / Textil, schwarz, kupfer  
luminaire de table; acier, cuivre / tissu, noir, cuivre

H 305, Ø 165



E14 1x 60W



9 002759 957872



### 95788 CARLTON 2

table light; steel, brass / fabric, black, gold  
Tischleuchte; Stahl, messing / Textil, schwarz, gold  
luminaire de table; acier, laiton / tissu, noir, or

H 305, Ø 165



E14 1x 60W



9 002759 957889





**97516**



**99289**

### 97516 CHIETINO 1

table light; wood, steel, natural, chrome / fabric, white  
Tischleuchte; Holz, Stahl, natur, chrom / Textil, weiss  
luminaire de table; bois, acier, nature, chrome / tissu, blanc

H 440, Ø 260, Base: B 235, T 235



E27 1x 60W

**99289**

Decoration not included  
in delivery.

Dekoration im Lieferumfang  
nicht enthalten.

Décoration non incluse  
dans la livraison.



9 002759 975166



### 99289 LIDSING

table light; steel, glass, chrome, clear / fabric, grey  
Tischleuchte; Stahl, Glas, chrom, klar / Textil, grau  
luminaire de table; acier, verre, chrome, clair / tissu, gris

H 480, Ø 240, Base: Ø 115



E27 1x 40W



9 002759 992897





99329



99331



95386

### 99329 MANALBA 1

table light; ceramic, silver / fabric, white, silver  
Tischleuchte; Keramik, silber / Textil, weiss, silber  
luminaire de table; céramique, argent / tissu, blanc, argent

H 300, Ø 200, Base: Ø 125



E14 1x 40W



9 002759 993290



### 99331 MANALBA 1

table light; ceramic, gold-coloured / fabric, black, gold  
Tischleuchte; Keramik, goldfarben / Textil, schwarz, gold  
luminaire de table; céramique, doré / tissu, noir, or

H 300, Ø 200, Base: Ø 125



E14 1x 40W



9 002759 993313



### 95386 MANALBA

table light; steel, gold / fabric, black, gold  
Tischleuchte; Stahl, gold / Textil, schwarz, gold  
luminaire de table; acier, or / tissu, noir, or

H 380, Ø 250



E27 1x 60W



9 002759 953867





**93046**



**99332**



**97773**

### 93046 TRONDIO

table light; ceramic, white / fabric, white  
Tischleuchte; Keramik, weiss / Textil, weiss  
luminaire de table; céramique, blanc / tissu, blanc

H 270, Ø 150, Base: Ø 120



E14 1x 40W



9 002759 930462



### 99332 BELLARIVA 3

table light; ceramic, white / fabric, linen, light brown  
Tischleuchte; Keramik, weiss / Textil, Leinen, hellbraun  
luminaire de table; céramique, blanc / tissu, lin, marron clair

H 360, Ø 200, Base: Ø 160

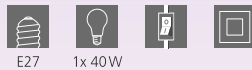

E27 1x 40W



9 002759 993320



### 97773 BELLARIVA

table light; ceramic, creme-white / fabric, white  
Tischleuchte; Keramik, creme-weiss / Textil, weiss  
luminaire de table; céramique, blanc crème / tissu, blanc

H 320, Ø 150, Base: Ø 120



E14 1x 40W



9 002759 977733





**97774**

### 97774 BELLARIVA

table light; ceramic, grey / fabric, white  
Tischleuchte; Keramik, grau / Textil, weiss  
luminaire de table; céramique, gris / tissu, blanc

H 320, Ø 150, Base: Ø 120



E14



1x 40W



9 002759 977740



DESIGN  
HIGHLIGHT  
DETAIL



99333



93044



99825

### 99333 MATARO 1

table light; ceramic, black / fabric, white  
Tischleuchte; Keramik, schwarz / Textil, weiss  
luminaire de table; céramique, noir / tissu, blanc

L 130, B 110, H 300, Base: B 105, T 85



E14 1x 40W



9 002759 993337



### 93044 MATARO

table light; ceramic, grey / fabric, white  
Tischleuchte; Keramik, grau / Textil, weiss  
luminaire de table; céramique, gris / tissu, blanc

L 130, B 130, H 300, Base: B 105, T 85



E14 1x 40W



9 002759 930448



### 99825 CAHUAMA

table light; ceramic, white, black / glass, grey matt  
Tischleuchte; Keramik, weiss, schwarz / Glas, grau matt  
luminaire de table; céramique, blanc, noir / verre, gris mat

H 300, Ø 275



E27 1x 40W



9 002759 998257





99824

### 99824 CAHUAMA

table light; ceramic, light brown / glass, white  
Tischleuchte; Keramik, hellbraun / Glas, weiss  
luminaire de table; céramique, marron clair / verre, blanc

H 300, Ø 275



E27



1x 40W



Ø 275



H 300



9 002759 998240



DESIGN  
HIGHLIGHT  
DETAIL



94513

LED



98278

### 99084 CERCAMAR

table light; glass, clear  
Tischleuchte; Glas, klar  
luminaire de table; verre, clair

H 120, Ø 110

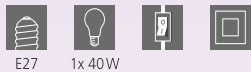

E27 1x 40W



9 002759 990848



Ø 110

H 120

### 94513 PETTO 1

table light; steel, white  
Tischleuchte; Stahl, weiss  
luminaire de table; acier, blanc

H 135, Ø 105, Base: Ø 90



GU10 1x 3W  
warm  
WHITE  
1x  
250lm



9 002759 945138

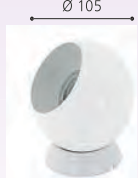

Ø 90

H 135

### 98278 MAMBLAS

table light; wood, steel, brown / plastic, white  
Tischleuchte; Holz, Stahl, braun / Kunststoff, weiss  
luminaire de table; bois, acier, marron / plastique, blanc

H 310, Ø 200, Base: Ø 105



E27 1x 60W



9 002759 982782

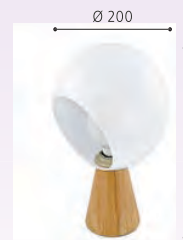

Ø 105

H 310





**98864**

### 98864 AMEZAGA

table light; steel, black, brass  
Tischleuchte; Stahl, schwarz, messing  
luminaire de table; acier, noir, laiton

L 355, B 160, H 575, Base: Ø 170



E27



1x 10W



9 002759 988647





98837

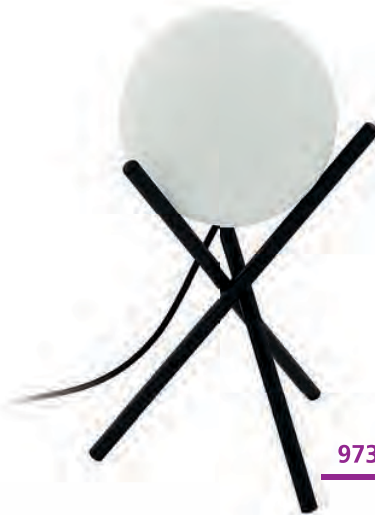

97333



EGLO  
RECOMMENDS  
11604

97333



EGLO  
RECOMMENDS  
11534

97209



DESIGN  
HIGHLIGHT  
DETAIL



97209

### 98837 ERMUA

table light; steel, wood, black, brown / plastic, white  
Tischleuchte; Stahl, Holz, schwarz, braun / Kunststoff, weiss  
luminaire de table; acier, bois, noir, marron / plastique, blanc

L 350, B 165, H 470, Base: B 240, T 160



4,5W 526lm



9 002759 988371



B 240

### 97333 CASTELLATO

table light; steel, black / glass opal-matt, white  
Tischleuchte; Stahl, schwarz / Glas opal-matt, weiss  
luminaire de table; acier, noir / verre opale mat, blanc

H 330, Ø 210



E14 1x 28W



9 002759 973339



Ø 210

### 97209 OLIVAL 1

table light; steel, black / smoked glass, black-transparent  
Tischleuchte; Stahl, schwarz / Rauchglas, schwarz-transparent  
luminaire de table; acier, noir / verre fumé, noir transparent

L 200, B 200, H 305



E27 1x 40W



9 002759 972097



L 200



**87254**



**87256**



**85104**

### 87254 SOLO 1

table light; steel, brass-matt / satin glass, white  
Tischleuchte; Stahl, messing-matt / Glas satiniert, weiss  
luminaire de table; acier, laiton mat / verre satiné, blanc

H 350, Ø 260, Base: Ø 130



E14 1x 40W



9 002759 872540



### 87256 SOLO 1

table light; steel, wood, bronzed, nut / satin glass, white  
Tischleuchte; Stahl, Holz, brüniert, Nuss / Glas satiniert, weiss  
luminaire de table; acier, bois, bruni, noisette / verre satiné, blanc

H 350, Ø 260, Base: Ø 130



E14 1x 40W



9 002759 872564



### 85104 SOLO 1

table light; steel, satin nickel / satin glass, white  
Tischleuchte; Stahl, nickel-matt / Glas satiniert, weiss  
luminaire de table; acier, nickel mat / verre satiné, blanc

H 350, Ø 260, Base: Ø 130



E14 1x 40W



9 002759 851040





95775 | 95776



95775



95776



98887

### 95775 DAMASCO 1

table light; steel, satin nickel / satin glass, white  
Tischleuchte; Stahl, nickel-matt / Glas satiniert, weiss  
luminaire de table; acier, nickel mat / verre satiné, blanc

H 215, Ø 100



E27 1x 60W



9 002759 957759



### 95776 DAMASCO 1

table light; steel, chrome / satin glass, white  
Tischleuchte; Stahl, chrom / Glas satiniert, weiss  
luminaire de table; acier, chrome / verre satiné, blanc

H 215, Ø 100

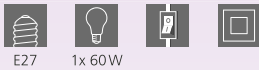

E27 1x 60W



9 002759 957766



### 98887 DAMASCO 1

table light; steel, black / glass vaporized, black-transparent  
Tischleuchte; Stahl, schwarz / Glas bedampft, schwarz-transparent  
luminaire de table; acier, noir / verre vaporisé, noir transparent

H 310, Ø 100



E27 1x 60W



9 002759 988876





99597

LED

# OFFICE TABLE & FLOOR LUMINAIRES

BÜRO TISCH- & STEHLEUCHTEN

LUMINAIRES DE TABLE & LAMPADAIRES À BUREAU

## WE LOVE LIGHT -

The range of office table and floor luminaires is made up of many different styles and convinces with its diverse uses.

## WIR STEHEN AUF LICHT -

Das Sortiment der Büro Tisch- und Stehleuchten setzt sich aus unterschiedlichen Stilen zusammen und überzeugt mit seinen vielseitigen Einsatzmöglichkeiten.



## NOUS NOUS TENONS EN PLEINE LUMIÈRE -

La gamme d'éclairages de table et sur pieds à bureau est formée de différents styles et persuade par ses multiples possibilités d'application.



99831

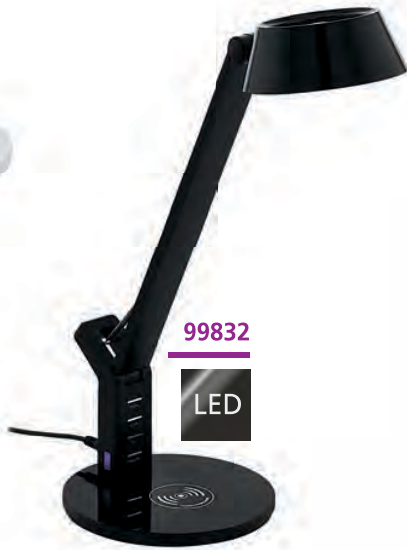

99832



93901

The touch buttons can be used to dim the luminaire and adjust the light colour.

Über die Berührungsschalter kann man die Leuchte dimmen und die Lichtfarbe einstellen.

Les boutons tactiles peuvent être utilisés pour dimmer et régler la couleur de la lumière.



93901



**99831 BANDERALO**

table light; plastic, white  
Tischleuchte; Kunststoff, weiss  
luminaire de table; plastique, blanc

L 295, B 170, H 405, Base: Ø 170



4,8W 700lm



9 002759 998318



**99832 BANDERALO**

table light; plastic, black  
Tischleuchte; Kunststoff, schwarz  
luminaire de table; plastique, noir

L 295, B 170, H 405, Base: Ø 170



4,8W 700lm



9 002759 998325



**93901 SELLANO**

table light; plastic, steel, white  
Tischleuchte; Kunststoff, Stahl, weiss  
luminaire de table; plastique, acier, blanc

H 430, Base: B 180, T 180

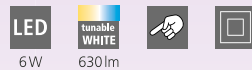

6W 630lm



9 002759 939014

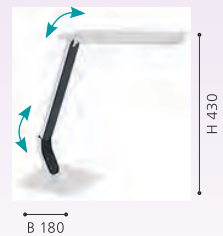

DESIGN  
HIGHLIGHT  
DETAIL



93966

LED



93965

LED



97915

LED

### 93966 CAUPO

table light; plastic, steel, black  
Tischleuchte; Kunststoff, Stahl, schwarz  
luminaire de table; plastique, acier, noir

L 260, H 320, Base: B 150, T 150



2,9W 280lm



9 002759 939663

### 93965 CAUPO

table light; plastic, steel, white  
Tischleuchte; Kunststoff, Stahl, weiss  
luminaire de table; plastique, acier, blanc

L 260, H 320, Base: B 150, T 150



2,9W 280lm



9 002759 939656

### 97915 COGNOLI

table light; plastic, white  
Tischleuchte; Kunststoff, weiss  
luminaire de table; plastique, blanc

L 70, B 100, H 510



3,2W 300lm



9 002759 979157





97914

LED

### 97914 COGNOLI

table light; plastic, black  
Tischleuchte; Kunststoff, schwarz  
luminaire de table; plastique, noir

L 70, B 100, H 510

LED

3,2W

neutral  
WHITE

300lm



L 70

H 510



9 002759 979140



DESIGN  
HIGHLIGHT  
DETAIL



96437

LED



96434

LED



96438

LED

### 96437 LAROA

clamp light; plastic, black  
Klemmleuchte; Kunststoff, schwarz  
luminaire à pince; plastique, noir

L 450, B 65, H 275



4,5W 550lm



9 002759 964375



### 96434 LAROA

clamp light; plastic, white  
Klemmleuchte; Kunststoff, weiss  
luminaire à pince; plastique, blanc

L 450, B 65, H 275



4,5W 550lm



9 002759 964344

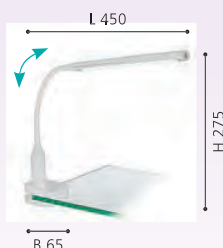

### 96438 LAROA

table light; plastic, black  
Tischleuchte; Kunststoff, schwarz  
luminaire de table; plastique, noir

L 480, B 120, H 325, Base: B 170, T 120



4,5W 550lm



9 002759 964382





96435

LED

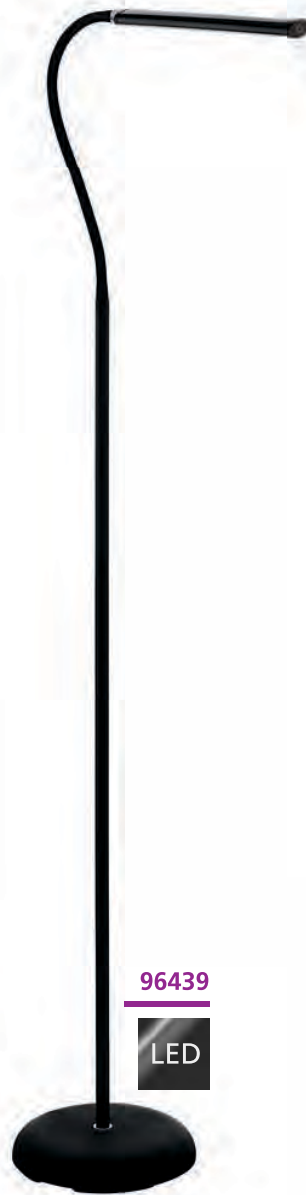

96439

LED



96436

LED

### 96435 LAROA

table light; plastic, white  
Tischleuchte; Kunststoff, weiss  
luminaire de table; plastique, blanc

L 480, B 120, H 325, Base: B 170, T 120



4,5W



550lm



9 002759 964351

### 96439 LAROA

floor light; plastic, black  
Stehleuchte; Kunststoff, schwarz  
lampadaire; plastique, noir

L 535, B 215, H 1300, Base: Ø 210



4,5W



550lm



9 002759 964399

### 96436 LAROA

floor light; plastic, white  
Stehleuchte; Kunststoff, weiss  
lampadaire; plastique, blanc

L 535, B 215, H 1300, Base: Ø 210



4,5W



550lm

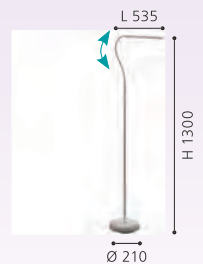

9 002759 964368



98855

LED



98856

LED

### 98855 CEPPINO

table light; steel, black, white  
Tischleuchte; Stahl, schwarz, weiss  
luminaire de table; acier, noir, blanc

H 380, Base: B 165, T 110

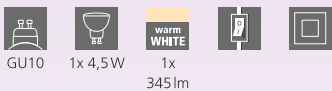

GU10 1x 4,5W 1x 345lm



9 002759 988555



B 165

### 98856 CEPPINO

table light; steel, white  
Tischleuchte; Stahl, weiss  
luminaire de table; acier, blanc

H 380, Base: B 165, T 110

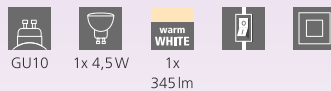

GU10 1x 4,5W 1x 345lm



9 002759 988562



B 165

### 98832 VERADAL

table light; wood, plastic, white, brown / steel, white  
Tischleuchte; Holz, Kunststoff, weiss, braun / Stahl, weiss  
luminaire de table; wood, plastic, blanc, marron / acier, blanc

B 125, H 420, Base: Ø 160



E27 1x 40W



9 002759 988326



Ø 160



98832



### 98831 VERADAL

table light; wood, plastic, black, brown / steel, black  
Tischleuchte; Holz, Kunststoff, schwarz, braun / Stahl, schwarz  
luminaire de table; wood, plastic, noir, marron / acier, noir

B 125, H 420, Base: Ø 160



E27



1x 40W



9 002759 988319



98831





93078

LED



94673

LED

### 93078 DURENGO

table light; plastic, steel, white, chrome  
Tischleuchte; Kunststoff, Stahl, weiss, chrom  
luminaire de table; plastique, acier, blanc, chrome

H 380, Ø 160, Base: Ø 160



3W 230lm



9 002759 930783



### 94673 DAMBERA

table light; plastic, black  
Tischleuchte; Kunststoff, schwarz  
luminaire de table; plastique, noir

H 375, Base: Ø 170



4,5W 520lm



9 002759 946739



### 94677 SNAPORA

table light; plastic, aluminium, black  
Tischleuchte; Kunststoff, Alu, schwarz  
luminaire de table; plastique, aluminium, noir

H 485, Base: Ø 110



3,5W 330lm



9 002759 946777





95696

LED

### 95694 CAJERO

table light; plastic, silver  
Tischleuchte; Kunststoff, silber  
luminaire de table; plastique, argent

L 150, B 100, H 500

LED

4,5W

neutral  
WHITE

550lm

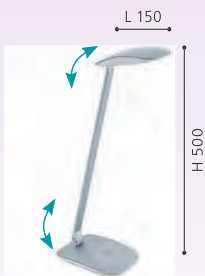

9 002759 956943



95694

LED



DESIGN  
HIGHLIGHT  
DETAIL



99019

### 99019 TABILLANO 1

table light; steel, black  
Tischleuchte; Stahl, schwarz  
luminaire de table; acier, noir

L 560, B 180, H 475, Base: Ø 180

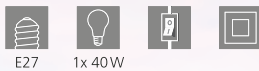

E27 1x 40W



9 002759 990190



### 96957 TORONA 1

table light; steel, white / wood, natural  
Tischleuchte; Stahl, weiss / Holz, natur  
luminaire de table; acier, blanc / bois, nature

L 445, B 180, H 605, Base: Ø 180



E14 1x 28W



9 002759 969578

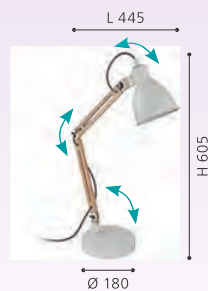





96957



**94699**



**94702**

### 94699 BORGILLIO

table light; steel, white  
Tischleuchte; Stahl, weiss  
luminaire de table; acier, blanc

### 94702 BORGILLIO

table light; steel, chrome  
Tischleuchte; Stahl, chrom  
luminaire de table; acier, chrome

### 94697 BORGILLIO

table light; steel, black  
Tischleuchte; Stahl, schwarz  
luminaire de table; acier, noir

L 400, B 190, H 710, Base: Ø 190



E27 1x 40W

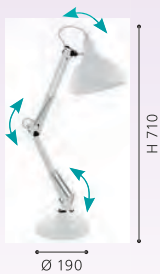

9 002759 946999

L 400, B 190, H 710, Base: Ø 190

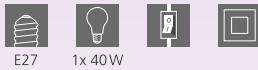

E27 1x 40W



9 002759 947026

L 400, B 190, H 710, Base: Ø 190



E27 1x 40W



9 002759 946975



94697



94704

### 94704 BORGILLIO

table light; steel, copper  
Tischleuchte; Stahl, kupfer  
luminaire de table; acier, cuivre

L 400, B 190, H 710, Base: Ø 190



E27



1x 40W

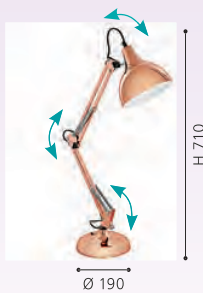



90967



90967

### 90967 BANKER

table light; steel, brass / glass painted, green  
Tischleuchte; Stahl, messing / Glas lackiert, grün  
luminaire de table; acier, laiton / verre laqué, vert

L 275, H 390



E27



1x 60W



9 002759 909673





86429



86955



92872

LED

### 86429 PRINCE 1

table light; steel, satin nickel / glass alabaster, white  
Tischleuchte; Stahl, nickel-matt / Glas alabaster, weiss  
luminaire de table; acier, nickel mat / verre albâtre, blanc

H 370, Base: Ø 125



E14 1x 25W



9 002759 864293



H 370

Ø 125

### 86955 FOX 1

table light; steel, satin nickel, chrome  
Tischleuchte; Stahl, nickel-matt, chrom  
luminaire de table; acier, nickel mat, chrome

H 330, Base: Ø 123

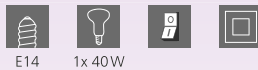

E14 1x 40W



9 002759 869557



H 330

Ø 123

### 92872 FOX

table light; steel, white, chrome  
Tischleuchte; Stahl, weiss, chrom  
luminaire de table; acier, blanc, chrome

H 320, Base: Ø 125



GU10 1x 3W  
warm  
WHITE  
1x  
240lm



9 002759 928728



H 320

Ø 125

# CHILDREN LUMINAIRES

KINDERLEUCHTEN

LUMINAIRES POUR ENFANTS

## PLAY OF COLOUR -

The nursery luminaires are characterised by their playful and child-friendly designs. The lovely motives light up in many different colours and turn the nursery into a very special location.

## FARBENSPIEL -

Die Kinderzimmerleuchten zeichnen sich durch ihr verspieltes und kindgerechtes Design aus. Die liebevollen Motive erleuchten in unterschiedlichsten Farben und machen das Kinderzimmer zu einem besonderen Ort.

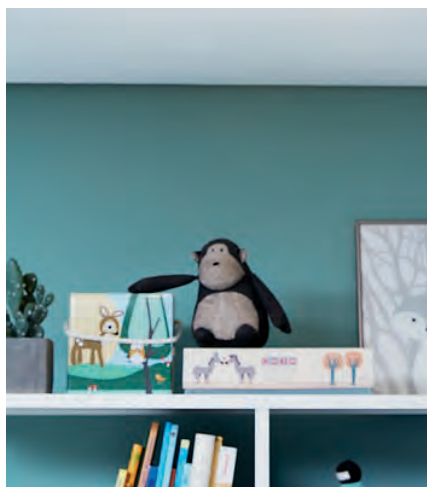

## JEU DE COULEUR -

Les éclairages de chambres d'enfants se distinguent de leur design joueur et adapté aux enfants. Les sujets formés avec amour sont illuminés dans des couleurs les plus variées et font de la chambre d'enfant un endroit spécial.





**97408**

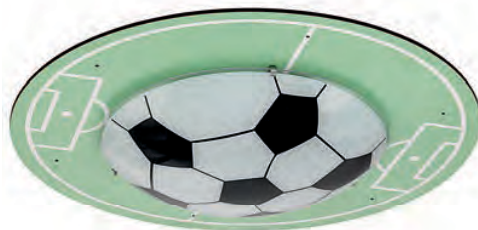

**97667**



**87284**



### 97408 SAN CARLO

ceiling light; wood, steel, coloured  
Deckenleuchte; Holz, Stahl, bunt  
plafonnier; bois, acier, coloré

L 425, B 435, H 80



E27 3x 40W

### 97667 TABARA

ceiling light; wood, steel, green, white / satin glass, design "soccer"  
Deckenleuchte; Holz, Stahl, grün, weiss / Glas satiniert, Motiv Fussball  
plafonnier; bois, acier, vert, blanc / verre satiné, motif «football»

H 80, Ø 400



E27 1x 60W

### 87284 JUNIOR 1

wall / ceiling light; steel, white / satin glass, design "soccer"  
Wand- / Deckenleuchte; Stahl, weiss / Glas satiniert, Motiv Fussball  
applique / plafonnier; acier, blanc / verre satiné, motif «football»

Ø 245



E27 1x 60W



9 002759 974084



L 425

B 435



9 002759 976675



Ø 400



9 002759 872847



Ø 245





97575



97575

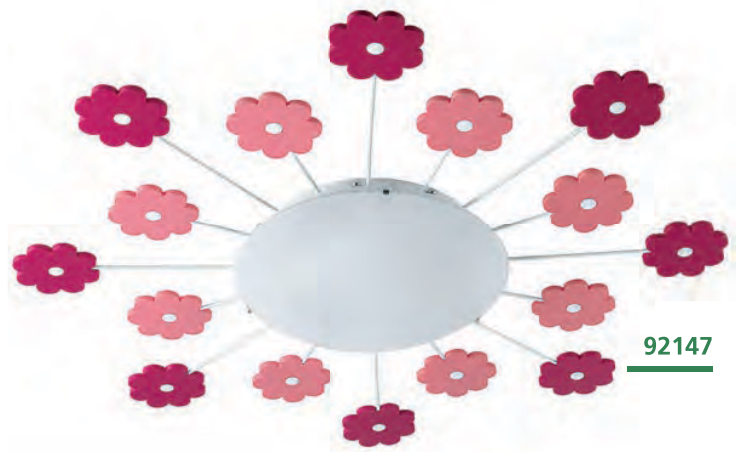

92147



92146

### 97575 RUFFO

ceiling light; steel, white / fabric, coloured  
Deckenleuchte; Stahl, weiss / Textil, bunt  
plafonnier; acier, blanc / tissu, coloré

H 110, Ø 380



### 92146 VIKI 1

wall / ceiling light; steel, blue / satin glass, white  
Wand- / Deckenleuchte; Stahl, blau / Glas satiniert, weiss  
applique / plafonnier; acier, bleu / verre satiné, blanc

Ø 630, A 80



### 92147 VIKI 1

wall / ceiling light; steel, pink / satin glass, white  
Wand- / Deckenleuchte; Stahl, pink / Glas satiniert, weiss  
applique / plafonnier; acier, rose / verre satiné, blanc

Ø 615, A 80



9 002759 975753

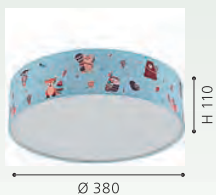

9 002759 921460

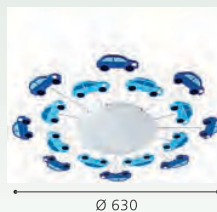

9 002759 921477

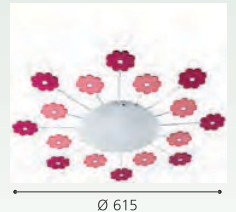

# EGLO WORLDWIDE

EGLO WELTWEIT

EGLO DANS LE MONDE



 **HEADQUARTERS**  
EGLO LEUCHTEN GMBH  
Heiligkreuz 22  
A-6136 PILL  
T: +43 5242 6996 0 | F: +43 5242 6996 972  
E: info-austria@eglo.com

 **CHILE - SANTIAGO**  
EGLO CHILE ILUMINACION LTDA.  
Av. Américo Vespucio 1930  
Conchali - SANTIAGO DE CHILE  
T: +562 2 595 2222  
E: info-chile@eglo.com

 **DENMARK**  
EGLO DANMARK A/S  
Agerbakken 20  
DK-8362 Hørring  
T: +45 70 22 55 11 | F: +45 70 22 55 21  
E: info-denmark@eglo.com

 **AUSTRALIA**  
EGLO LIGHTING AUSTRALIA  
5/339 Archerfield Road  
Richlands | Queensland 4077  
T: +61 7 3375 1413 | F: +61 7 3375 1412  
E: info-australia@eglo.com

 **CHINA**  
DONGGUAN EGLO CHINA LIGHTING CO., LTD.  
No.1 | Shangqiao Industrial Road | Shangqiao,  
Dongcheng District  
DONGGUAN CITY, GUANZHOU PROVINCE | CHINA  
T: +86 769 2203 3866 | F: +86 769 2203 6866  
E: info-china@eglo.com

 **ESTONIA**  
MOODNE VALGUSTUS AS  
Rävala pst. 7  
EE-10143 TALLINN  
T: +372 667 6670 | F: +372 631 3195  
E: info-global@eglo.com

 **BELGIUM**  
EGLO BELGIUM B.V.B.A.  
Antwerpsesteenweg 247 | B-2950 Kapellen  
Visit Adress: Innovatiepark 20 |  
4906 AA OOSTERHOUT (NL)  
T: +32 3 250 60 80 | F: +32 3 219 80 67  
E: info-belgium@eglo.com

 **COLOMBIA**  
EGLO COLOMBIA ILUMINACION SAS  
AUTOPISTA NORTE KM 19 COSTADO LOTE 30  
BOGOTÁ - CHIA  
T: +57 (1) 744 2339  
E: info-global@eglo.com

 **FINLAND**  
EGLO FINLAND OY  
Malmniraitti 17A  
00700 Helsinki  
T: +358 20 7649 820 | F: +358 20 7649 821  
E: info-finland@eglo.com

 **BOSNIA-HERZEGOVINA**  
EGLO RASVJETA BH D.O.O.  
Ormanica bb  
BIH-76250 GRADACAC  
T: +387 35 86 85 00 | F: +387 35 82 44 41  
E: Info-Bosnia-Herzegovina@eglo.com

 **COSTA RICA**  
EGLO Costa Rica, Centro Comercial Calle Real local #8  
Guachipilín de Escazú de la sucursal del BAC  
San Jose 800 metros al norte San Jose Costa Rica.  
T: +506-2289-4690, +506-2100-6384  
E: Info-CostaRica@eglo.com

 **FRANCE**  
EGLO FRANCE LUMINAIRE SARL  
Z.A. Jeune Bois | 2 Rue de la Martinique  
F-68274 WITTENHEIM  
T: +33 389 6250 30 | F: +33 389 6250 49  
E: info-france@eglo.com

 **BULGARIA**  
EGLO BULGARIA EOOD  
Main Road Burgas-Sofia, 5th kilometer,  
Building KACHIKA, 8000 BOURGAS, Bulgaria  
T: +359 56 960 403 | F: +359 56 53 05 95  
E: info-bulgaria@eglo.com

 **CROATIA**  
EGLO RASVJETA D.O.O.  
Josipa Loncara 3  
HR-10000 ZAGREB  
T: +385 1 379 40 62 | F: +385 1 379 41 04  
E: info-croatia@eglo.com

 **GERMANY**  
EGLO LEUCHTEN HANDELS GMBH  
Kleinbahnstr. 35  
D-59759 ARNSBERG  
T: +49 2932 6269 0 | F: +49 2932 6269 39  
E: info-germany@eglo.com

 **CANADA**  
EGLO CANADA INC.  
20700 Route Transcanadienne  
Baie-D'Urfé, Québec | H9X 4B7  
T: +1 514 457 5483 | F: +1 514 457 5487  
E: info-canada@eglo.com

 **CZECH REPUBLIC**  
EGLO CZ+SK s.r.o.  
Náchodská 2479/63  
CZ-193 00 PRAHA 9 Horní Počernice  
T: +420 281 924 163 | F: +420 281 925 205  
E: info-czechrepublic@eglo.com

 **GREECE**  
EGLO HELLAS A.E.  
Sykias 2 and parodos dekeleias  
ACHARNAI, GR-13679  
T: +30 210 240 77 10 | F: +30 210 240 07 29  
E: info-greece@eglo.com



**GREAT BRITAIN**  
EGLO UK LTD.  
Unit 12 Cirrus Park, Lower Farm Road, Moulton Park  
Industrial Estate, NORTHAMPTON NN3 6UR  
T: +44 1604 790 986 | F: +44 1604 670 282  
E: info-greatbritain@eglo.com



**MOROCCO**  
EGLO AFRICA  
219 Bd Med Zerkouni. Suite: 67  
20330 CASABLANCA | Morocco  
T: +212 522 98 80 25 / 05  
E: info-global@eglo.com / info.africa@eglo.com



**SPAIN**  
EGLO ESPANA ILUMINACION S.L.  
Avda. de Castilla 1 (Edf. Best Point) 2º-16A  
San Fernando de Henares, E-28830 MADRID  
T: +34 91 677 9044 | F: +34 91 677 0304  
E: info-spain@eglo.com



**HUNGARY - PRODUCTION & LOGISTICS**  
EGLO MAGYARORSZAG KFT.  
Fő út. 155  
H-3060 PASZTO  
T: + 36 32 560 050 | F: +36 32 560 040  
E: info-hungary@eglo.com



**THE NETHERLANDS**  
EGLO VERLICHTING NEDERLAND B.V.  
Innovatiepark 20  
4906 AA OOSTERHOUT (NBR)  
T: +31 162 48 28 30 | F: +31 162 48 28 40  
E: Info-Netherlands@eglo.com



**SWEDEN**  
EGLO SVERIGE AB  
Star Street 1  
SE-512 50 SVENLJUNGA  
T: +46 340 623 505 | F: +46 340 623 605  
E: info-sweden@eglo.com



**INDIA**  
EGLO INDIA PRIVATE LIMITED  
A-307 Ansal Chamber-1, 3 Bhikaji Cama Place,  
New Delhi-110066  
T: +91 852 794 4288 | T: +91 971 122 0209  
E: info-india@eglo.com



**NORWAY**  
MS Belysning AS  
Heiaveien 4  
NO-1900 FETSUND  
T: +47 63 888500 | F: +47 63 888501  
E: info-norway@eglo.com



**SWITZERLAND**  
EGLO SCHWEIZ AG  
Seetalstraße 142  
CH-6032 EMMEN  
T: +41 41 268 69 59 | F: +41 41 268 69 58  
E: info-switzerland@eglo.com



**ITALY**  
EGLO ITALIANA S.R.L.  
Via Giotto, 4  
I-31021 MOGLIANO VENETO (TV)  
T: +39 041 45 66 232/245/251 | F: +39 041 45 74 066/071  
E: info-italy@eglo.com



**PERU**  
EGLO PERU S.A.C  
Avda. Santa Cruz No. 458 Distrito de San Isidro  
Provincia y Departamento Lima, San Isidro - Lima  
T: +51 1 4212 158  
E: info-peru@eglo.com



**TURKEY**  
Eglo Aydınlatma İthalat İhracat Ltd. Şti.  
Eyüp Sultan Mah. Sekmen Cad. No:18/2  
34855 SAMANDIRA, SANCaktepe / İSTANBUL  
T: +90 216 311 09 -02 / -03 / -04 | F: +90 216 311 09 -05  
E: info-turkey@eglo.com



**KAZAKHSTAN**  
EGLO KAZAKHSTAN LLP  
Office 72, 14<sup>th</sup> floor, Block 4A, Nurlı-Tau Business Centre,  
Al-Farabi Avenue 7, 050059 Almaty, Kazakhstan  
T: +7 727 293 25 20 | M: +7 701 031 00 00  
E: info-kazakhstan@eglo.com



**POLAND**  
EGLO POLSKA SP. Z.O.O.  
Ul. Pulawska 479  
02-844 WARSZAWA  
T: +48 22 644 57 55 | F: +48 22 644 89 82  
E: info-poland@eglo.com



**USA**  
EGLO USA, INC.  
3640 Royal South Parkway  
ATLANTA, GEORGIA 30349  
T: +1 404 477 5601 | F: +1 404 393 7053  
E: info-usa@eglo.com



**KOSOVO**  
EGLO KOSOVA LLC  
Lugisht e qytetit pn  
20000 PRIZREN-KOSOVO  
T: +377 44 2166 87 | Shop: +381 29 2442 84  
E: info-kosovo@eglo.com



**PORTUGAL**  
EGLO PORTUGAL ILUMINAÇÃO, LDA  
Rua Fonte Parada, 125  
PT-4595-434 SEROA-PAÇOS DE FERREIRA  
T: +351 255 890 000 | F: +351 255 892 346  
E: info-portugal@eglo.com



**UKRAINE**  
EGLO UKRAINE LTD  
bulv. Vatslav Havel 6/7A  
UA-03680 KIEV  
T: +38 044 463 98 41 | F: +38 044 468 84 67  
E: info-ukraine@eglo.com



**LITHUANIA**  
MOODNE VALGUSTUS AS  
Rāvāla pst. 7  
EE-10143 TALLINN  
T: +370 652 49923 | T: +372 667 6670  
E: info-lithuania@eglo.com



**ROMANIA**  
EGLO ROMANIA PRODEXIM SRL.  
Str. Atomistilor nr. 1D  
R-077125 MAGURELE - ILFOV - ROMANIA  
T: +40 314 250 902 | F: +40 314 250 899  
E: info-romania@eglo.com



**MAGYARORSZÁG – ÉRTÉKESÍTÉS**  
EGLO LUX KFT.  
Fő út. 143/A  
H-2120 DUNAKESZI  
T: +36 27 341 353 | F: +36 27 341 409  
E: info-hungary@eglo.com



**RUSSIA**  
EGLO LIGHTING LLC  
Varshavskoe shosse 35 | Building 1  
RU-117105 | MOSCOW  
T: +7495 789 4311 | F: +7495 789 4312  
E: info-russia@eglo.com



**MALAYSIA**  
EGLO ASIA SDN BHD  
No. 13, Jalan Pelukis U1/46B, Temasya 18, Glenmarie,  
40150 Shah Alam, Selangor Darul Ehsan, Malaysia  
T: +6011 1050 2336 | F: +603 5567 9415  
E: info-malaysia@eglo.com



**SERBIA**  
EGLO RASVETA DOO  
Stefana Prvovenčanog 28  
11000 BEOGRAD | SRBIJA  
T: +381 11 3981 366 | F: +381 11 3981 389  
E: info-serbia@eglo.com



**MEXICO**  
EGLO MÉXICO ILUMINACIÓN S DE RL DE CV  
Prolongación Avenida López Mateos Sur N°3561,  
Fraccionamiento Los Gavilanes.  
C.P. 45645, Tlajomulco de Zúñiga, Jalisco, México  
T: +52 33 3687 20 95 | E: info-mexico@eglo.com



**SLOVAKIA**  
EGLO CZ+SK s.r.o  
Náchodská 2479/63  
CZ-193 00 PRAHA 9 Horní Počernice  
T: +421 313 211 551 | F: +421 313 211 556  
E: info-slovakia@eglo.com



**MIDDLE EAST**  
EGLO LIGHTING MIDDLE EAST FZE  
P.O. BOX 262073, LOB 6, OFFICE G18  
JEBEL ALI, DUBAI, UAE  
T: +97 148810080 | F: +97 148810081  
E: info.me@eglo.com



**SLOVENIA**  
EGLO RASVJETA D.O.O.  
Josipa Lončara 3  
HR-10000 ZAGREB  
T: +386 158 093 18  
E: info-slovenia@eglo.com



EGLO Leuchten GmbH  
Heiligkreuz 22  
A-6136 Pill  
Austria  
Tel. +43 (0) 5242 6996  
Fax +43 (0) 5242 6996-972  
info@eglo.com  
www.eglo.com

my light | my style

KAT-21