

TISVA®

FEEL THE WARMTH. SEE THE LIGHT.

An initiative of USHA INTERNATIONAL LTD.

ARCHITECTURAL



TISVA, inspired by the concepts of TVISA (light) and TATTVA (essence), brings alive the essence of light.

TISVA brings you a collection of aesthetic luminaires to indulge your emotions and play with light. Be it a designer corner at your home or your kids' room.

Choose light just as you like it. Modulate the brightness, adjust the colour and hue, from pure white to warm yellow, and for the adventurous, your choice of a vibrant spectrum of coloured light*.

Our designer home lights can be allied with your choice of lamp technology from our advanced LED LITESTIK range.

Designed with the highest quality, efficiency and concern for the environment, TISVA brings you the best in lighting.

INDEX

The Tisva Architectural Range is engineered for higher intensity, greater uniformity of light and seamless functionality. The range brings alive both the aesthetic and the functional aspect of architecture; interiors as well as exteriors. Technologically superior, these lights are long lasting and extremely reliable.

Ideal for accentuating elements, these high efficiency lights can be used in offices, hospitals, hotel lobbies and banks.

THE GAME CHANGERS!

LED COB DOWNLIGHTERS LOW UGR ORAIN VEROS PRO LEGEND PLUS GUO GALAXY PRO JENO LINOS VENZA SERIES RIO SF	Pg. 2
RINGS & LED MODULE IVEK COB RINGS IVEK PRO COB RINGS IVEK TRIMLESS COB RINGS EAGLE COB RINGS GIMBAL COB RINGS IVEK PRIME LED MODULE EAGLE LED MODULE EAGLE PRO LED MODULE	Pg. 28
TRACK LIGHTING SYSTEM CALANTE PRO AXIOS	Pg. 42
LED PANELS VITO VIURE EZIO RECESSED EZIO SURFACE VERTOS 2 X 2 PANEL	Pg. 54
LED STRIPS LUME SERIES - INDOOR LUME SERIES - OUTDOOR LUME SERIES - RGBWW LUME SERIES - ROPE LIGHT	Pg. 66
LANDSCAPE WALL LIGHTS BOLLARDS POST TOP GATE LIGHT	Pg. 70



LED COB DOWNLIGHTERS

LOWUGR | ORRIN | LEGENDPLUS | VEROSPRO | GVO | GALAXYPRO | JENO | LINOS | VENZASERIES | RIOSF

LOW UGR

- UGR <10
- DIE CAST ALUMINIUM HOUSING
- SLEEK DESIGN
-

13W



7.5W

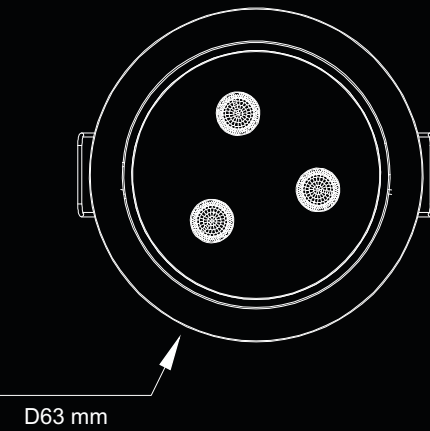
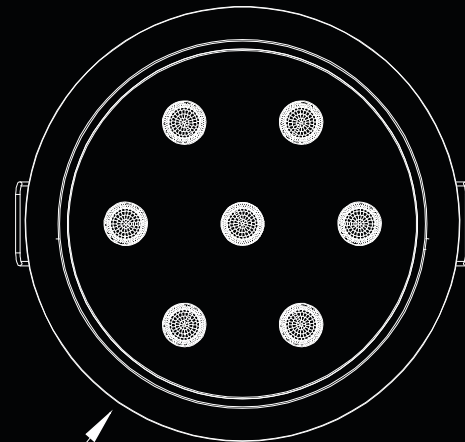
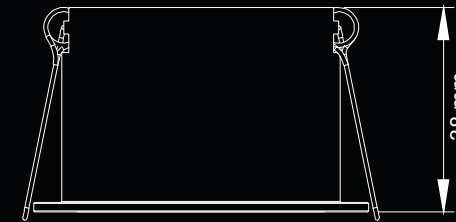

D82 mm

D63 mm

DOWNLIGHTER SIGNATURE SERIES

LOW UGR

DESCRIPTION

Recessed downlighter with superior eye comfort through better glare control. Compact, aesthetic and sleek design. Easy to mount on P.O.P ceilings

MATERIAL OF CONSTRUCTION

Die-cast aluminum housing with SS mounting clips

TECHNICAL INFORMATION

- Wattage:** 7.5W & 13W
- UGR:** ≤10, Ensures Practically No Glare.
- CRI:** ≥80, For Better Light Quality
- SDCM:** ≤3, Ensures Better Colour Consistency
- Input Voltage:** 220 V AC - 240 V AC
- Surge Protection:** ≤2.5KV
- IP Rating:** IP20,
- Life:** ≥30,000 Burning Hours
- Dimmability:** On Request. Please get in touch with Tisva Team for Dimming Options

Available In Body Color Options Of Black And White.

APPLICATION AREA

Residences | Hotels | Modern Work Spaces | Showrooms

LUMINOUS INTENSITY DISTRIBUTION CURVE

13W

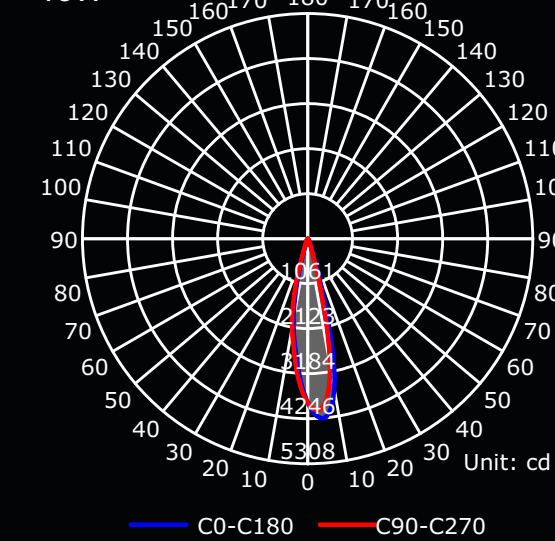

7.5W

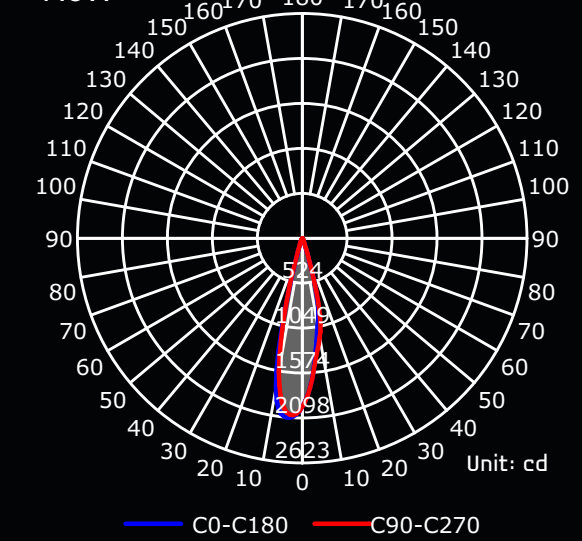

AVERAGE ILLUMINANCE AT A DISTANCE

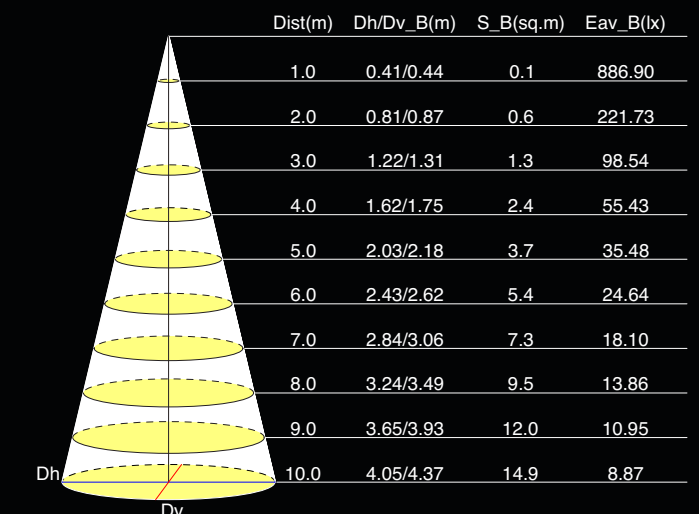
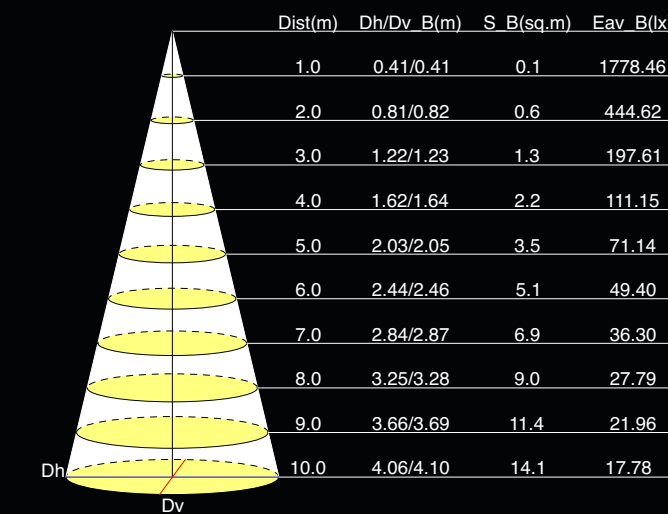

ITEM CODE	WATTAGE	CCT	DIMENSIONS (in cms)	LUMENS	CRI	IP RATING	SURGE RATING (KV)	INPUT VOLTAGE (AC)	Beam Angle
DL08W3K12R	7.5W	3000K	A - Ø6.3 C - 3.8 B - 5.8	350	≥80	20	≥2.5	220-240V	32°
DL08W4K12R	7.5W	4000K	A - Ø6.3 C - 3.8 B - 5.8	365	≥80	20	≥2.5	220-240V	32°
DL13W3K12R	13W	3000K	A - Ø8.2 C - 3.8 B - 7.5	755	≥80	20	≥2.5	220-240V	32°
DL13W4K12R	13W	4000K	A - Ø5.0 C - 3.8 B - 7.5	790	≥80	20	≥2.5	220-240V	32°

ORRIN

- DIE CAST ALUMINIUM
- WIDE WATTAGE RANGE 3W TO 20W
- DEEP RECESSED
- DIMMABLE/TUNABLE VERSION in 7.5 W
- TUNABLE VERSION in 13W



3W

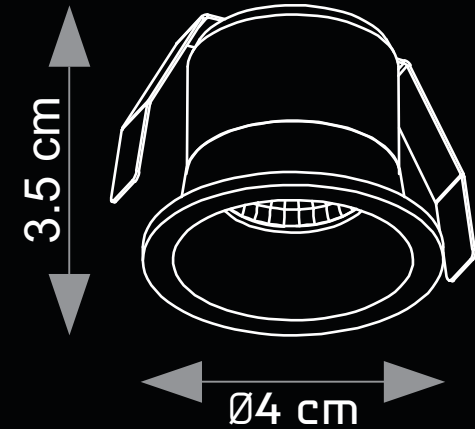

7.5W

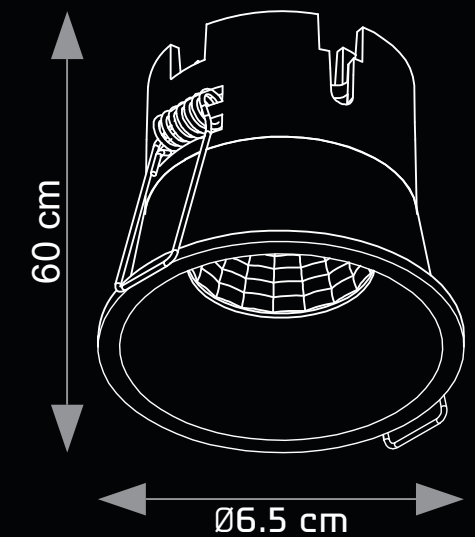

ORRIN

DESCRIPTION

Deep recessed Downlighter with perfect balance of optimal light output and low glare.

Available in wide range of wattages to suit variety of applications

Dimmable and Tunable versions available for select models

Optimized heat sink design for better heat dissipation and performance

MATERIAL OF CONSTRUCTION

Die-cast powder coated aluminum Housing with ss mounting clips

TECHNICAL INFORMATION

Wattage: 3W, 7.5W, 13W & 20W

CRI: ≥80, For Better Light Quality

SDCM: ≤5, Ensures Colour Consistency

Input Voltage: 220 V AC - 240 V AC

Surge Protection: ≤2.5KV

IP Rating: IP 20

Life: ≥30,000 Burning Hours

Dimmability: Dimmable Versions Available For 7.5W. Please get in touch with Tisva Team for other Dimming Options

APPLICATION AREA

Offices | Conference Halls | Hotels Showrooms | Residences

LED COB DOWNLIGHTERS

LUMINOUS INTENSITY DISTRIBUTION CURVE

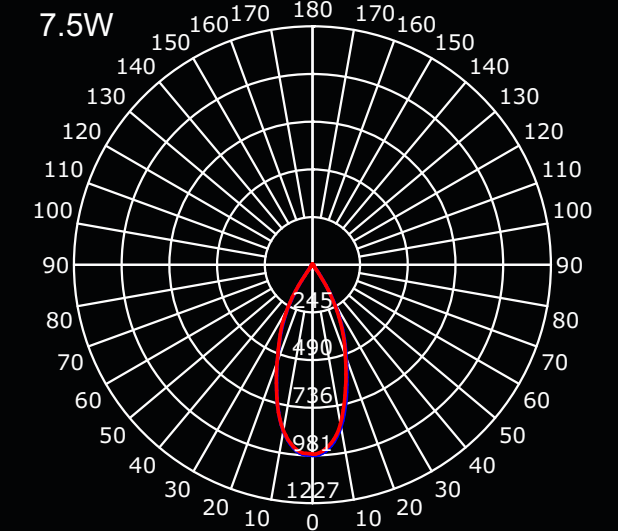
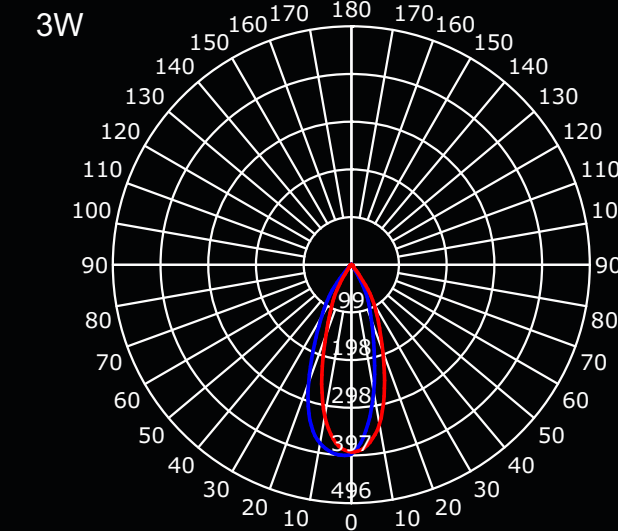

AVERAGE ILLUMINANCE AT A DISTANCE

Dist(m)	Dh/Dv_B(m)	S_B(sq.m)	Eav_B(lx)
1.0	0.69/0.67	0.4	163.99
2.0	1.37/1.35	1.5	41.00
3.0	2.06/2.02	3.4	18.22
4.0	2.75/2.69	6.0	10.25
5.0	3.43/3.37	9.4	6.56
6.0	4.12/4.04	13.5	4.56
7.0	4.81/4.71	18.4	3.35
8.0	5.50/5.38	24.0	2.56
9.0	6.18/6.06	30.4	2.02
10.0	6.87/6.73	37.5	1.64

Dist(m)	Dh/Dv_B(m)	S_B(sq.m)	Eav_B(lx)
1.0	0.76/0.76	0.5	397.75
2.0	1.53/1.53	1.8	99.44
3.0	2.29/2.29	4.1	44.19
4.0	3.05/3.05	7.3	24.86
5.0	3.82/3.82	11.5	15.91
6.0	4.58/4.58	16.5	11.05
7.0	5.35/5.35	22.5	8.12
8.0	6.11/6.11	29.3	6.21
9.0	6.87/6.87	37.1	4.91
10.0	7.64/7.64	45.8	3.98

ITEM CODE	WATTAGE	CCT	COLOUR	DIMENSIONS (in cms)	LUMENS	DIMMABLE	TUNABLE	BEAM ANGLE
DL0321101	3 W	3000 K	WHITE	A - Ø4.0 B - Ø3.5 C - 3.5	250	NO	NO	34°
DL3436D11	3 W	4000 K	WHITE	A - Ø4.0 B - Ø3.5 C - 3.5	365	NO	NO	34°
DL03210902	3 W	3000 K	BLACK	A - Ø6.5 B - Ø6.0 C - 6.0	250	NO	NO	34°
DL7521106	7.5 W	3000 K	WHITE	A - Ø6.5 B - Ø6.0 C - 6.0	600	NO	NO	38°
DL75231106	7.5 W	4000 K	WHITE	A - Ø6.5 B - Ø6.0 C - 6.0	630	NO	NO	38°
DL7336D09	7.5 W	3000 K	BLACK	A - Ø6.5 B - Ø6.0 C - 6.0	600	NO	NO	38°
DL7436D09	7.5 W	4000 K	BLACK	A - Ø6.5 B - Ø6.0 C - 6.0	630	NO	NO	38°
DL7521108	7.5 W	3000 K	WHITE	A - Ø6.5 B - Ø6.0 C - 6.0	600	YES	NO	38°
DL75231108	7.5 W	4000 K	WHITE	A - Ø6.5 B - Ø6.0 C - 6.0	630	YES	NO	38°
DL081911	7.5 W	2700 K / 4000K / 6000K	WHITE	A - Ø6.5 B - Ø6.0 C - 6.0	570/ 630/ 670	NO	YES	38°

Dimensions: A- LHW/Diameter | B- Cut Out Size | C- Height

ORRIN

LED COB DOWNLIGHTERS

13W



20W



LUMINOUS INTENSITY DISTRIBUTION CURVE

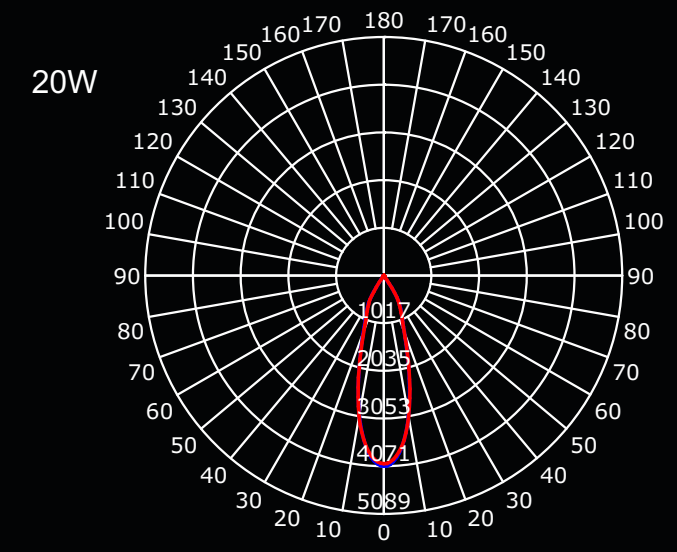
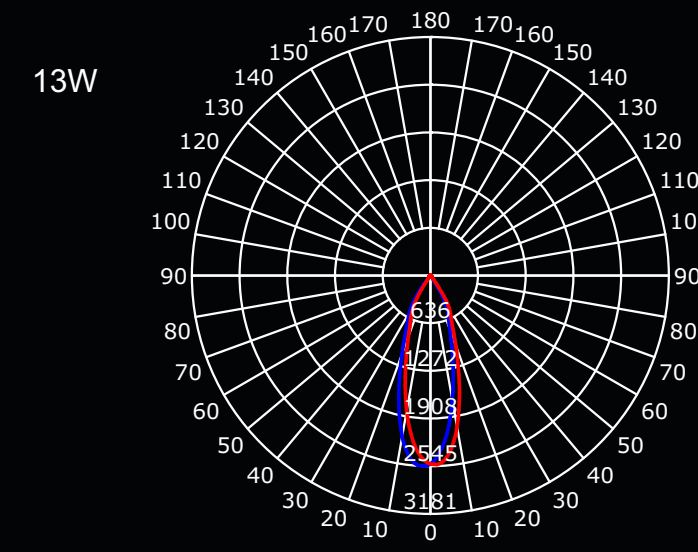

AVERAGE ILLUMINANCE AT A DISTANCE

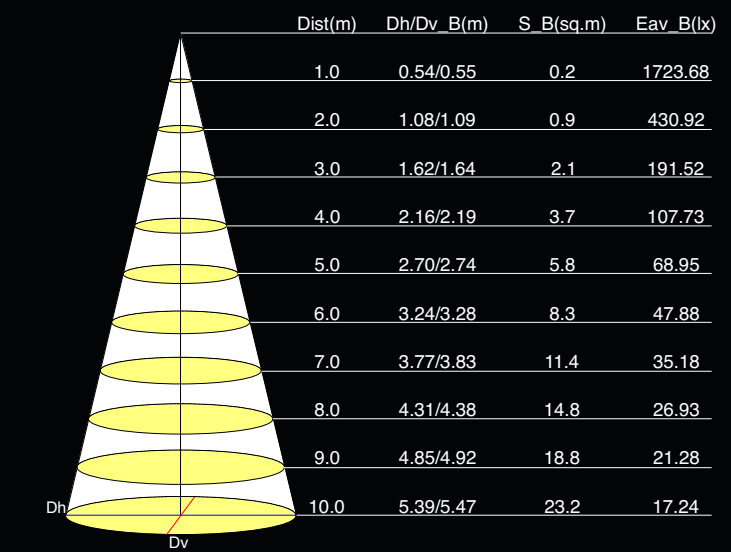
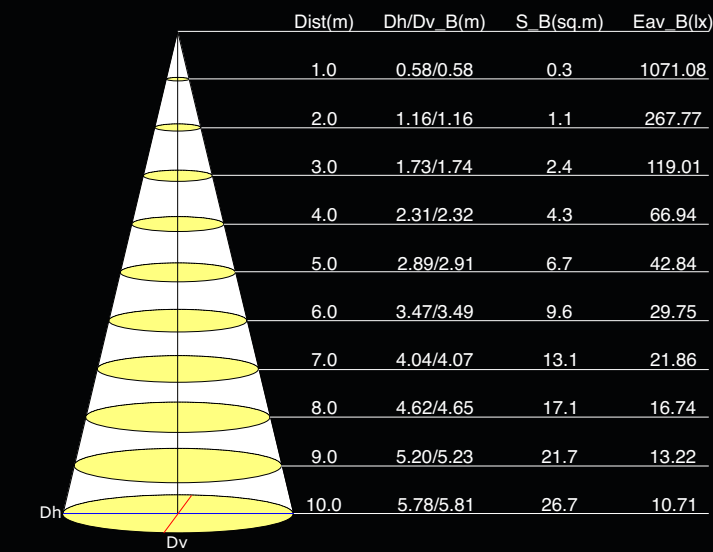

ITEM CODE	WATTAGE	CCT	COLOUR	DIMENSIONS (in cms)	LUMENS	DIMMABLE	TUNABLE	BEAM ANGLE
DL1321113	13 W	3000 K	WHITE	A - Ø8.5 B - Ø8 C - 8	1050	NO	NO	38°
DL1323113	13 W	4000 K	WHITE	A - Ø8.5 B - Ø8 C - 8	1120	NO	NO	38°
DL1333609	13 W	3000 K	BLACK	A - Ø8.5 B - Ø8 C - 8	1050	NO	NO	38°
DL1343609	13 W	4000 K	BLACK	A - Ø8.5 B - Ø8 C - 8	1120	NO	NO	38°
DL2021122	20 W	3000 K	WHITE	A - Ø9.5 B - Ø9 C - 9.6	1600	NO	NO	38°
DL2023122	20 W	4000 K	WHITE	A - Ø9.5 B - Ø9 C - 9.6	1680	NO	NO	38°
DL131911	13 W	2700 K 4000 K 6000 K	WHITE	A - Ø8.5 B - Ø8 C - 8	-	NO	YES	38° 38° 38°

LEGEND PLUS

- DIMMABLE VERSION
- LOW GLARE FOR BETTER EYE COMFORT
- SDCM₃ FOR BETTER COLOUR CONSISTENCY
- HIGH LIGHT OUTPUT
- UBER MODERN & SLEEK DESIGN



30 W

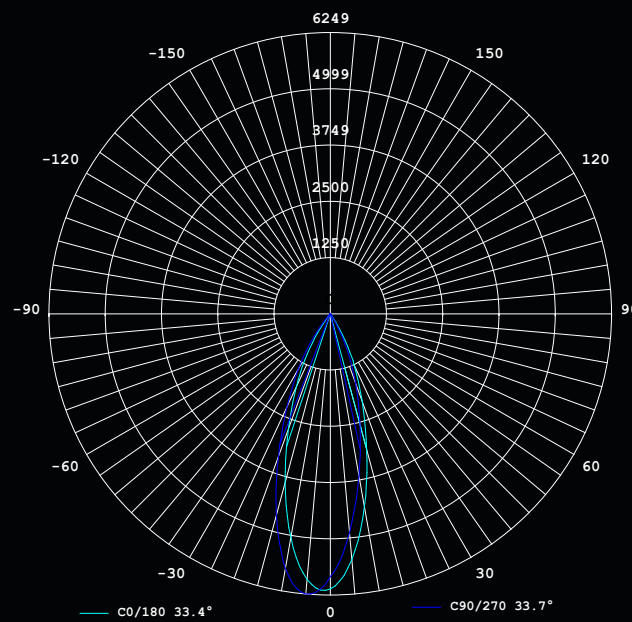
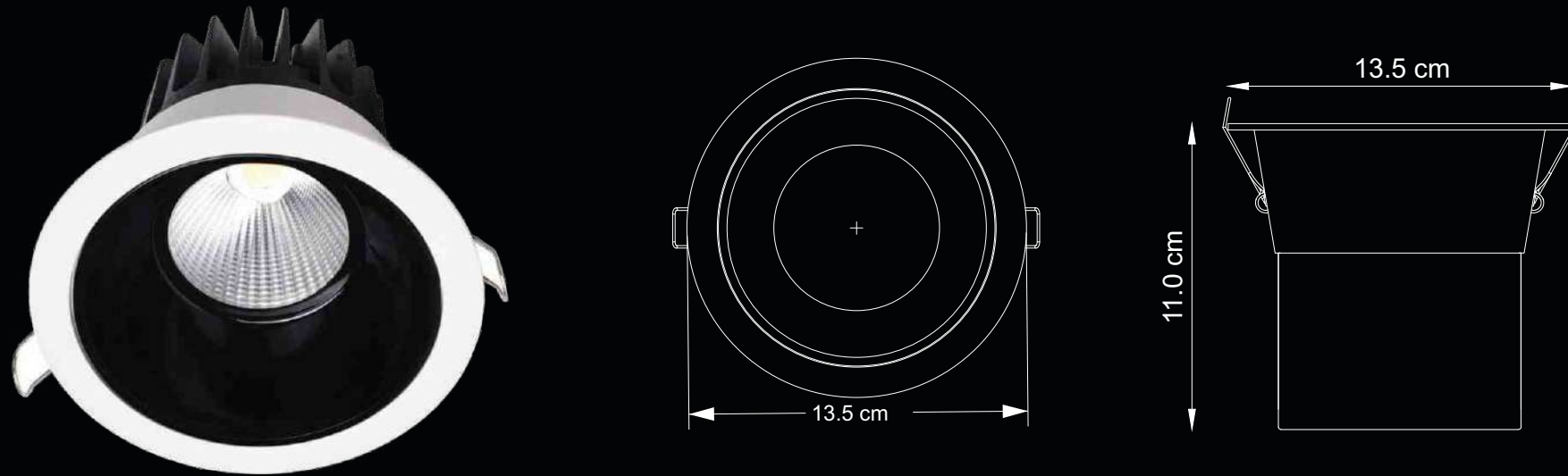

Height	AVR E	CENTER E	Diameter
1.50m	1822.71lx	2715.62lx	90.79cm
2.00m	1025.27lx	1527.54lx	
4.00m	256.32lx	381.88lx	242.11cm
4.50m	202.52lx	301.74lx	272.37cm
6.00m	113.92lx	169.73lx	363.16cm

Angle: 33.7deg

ITEM CODE	WATTAGE	CCT	DIMENSIONS (in cms)	LUMENS	CRI	IP RATING	SURGE RATING (KV)	INPUT VOLTAGE (AC)	BEAM ANGLE
DL3014208	30W	3000K	A - Ø13.5 B : Ø12.5 C - 11.0	2400	>80	20	≥2.5	220 V AC - 240 V AC	40°
DL3034209	30W	4000K	A - Ø13.5 B : Ø12.5 C - 11.0	2520	>80	20	≥2.5	220 V AC - 240 V AC	40°

Dimensions: A- LHW/Diameter | B- Cut Out Size | C- Height

LED COB DOWNLIGHTERS

DESCRIPTION

High performance deep recessed COB downlighters with aluminium housing.

Optimally designed heat sink for better heat dissipation and thus longer life and better light output.

Specially designed diffuser ensure soft light output for better eye comfort

MATERIAL OF CONSTRUCTION

Die Cast Aluminium with SS mounting clips

TECHNICAL INFORMATION

WATTAGE

Legend Plus: 30W
Veros Pro: 10W

CRI: ≥80, for better light quality

SDCM: ≤4, Superb colour consistency

IP RATING

Legend Plus: IP20,
Veros Pro: IP65,

Input Voltage: 220 V AC-240 V AC

Surge protection: <2.5KV

LIFE: ≥30,000 burning hours

Dimming option: Dimmable

APPLICATION AREA

Residences | Art Galleries | Retail | Museums | Modern Offices

VEROS PRO DIMMABLE

10 W

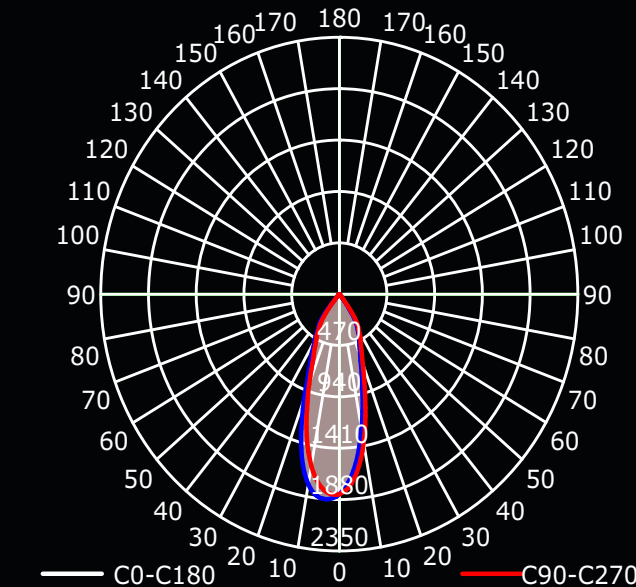
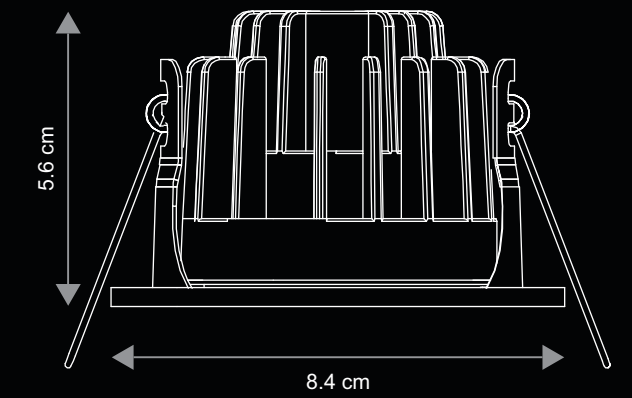

Dist(m)	Dh/Dv B(m)	S B(sq.m)	Eav B(lx)
1.0	0.63/0.64	0.3	776.65
2.0	1.26/1.28	1.3	194.16
3.0	1.89/1.91	2.9	86.29
4.0	2.52/2.55	5.2	48.54
5.0	3.15/3.19	8.1	31.07
6.0	3.78/3.83	11.7	21.57
7.0	4.41/4.46	15.9	15.85
8.0	5.04/5.10	20.8	12.14
9.0	5.68/5.74	26.3	9.59
10.0	6.31/6.38	32.5	7.77

ITEM CODE	WATTAGE	CCT	DIMENSIONS (in cms)	LUMENS	CRI	IP RATING	SURGE RATING (KV)	INPUT VOLTAGE (AC)	BEAM ANGLE
DL1011201	10W	3000K	A - Ø8.2 B - Ø7.5 C - 5	900	≥ 80	IP 65	≥2.5KV	220 V AC - 240 V AC	24°
DL1011301	10W	4000K	A - Ø8.2 B - Ø7.5 C - 5	960	≥ 80	IP 65	≥2.5KV	220 V AC - 240 V AC	24°
DL0931202	9W	4000K	A - Ø9.5 B - Ø8.2 C - 8.7	960	≥ 80	IP 65	≥2.5KV	220 V AC - 240 V AC	24°

Dimensions: A- LHW/Diameter | B- Cut Out Size | C- Height

GALAXY PRO

- DIMMABLE VERSION GVO 12 W
- LOW GLARE FOR BETTER EYE COMFORT
- HIGH LIGHT OUTPUT
- UBER MODERN & SLEEK DESIGN



7 W

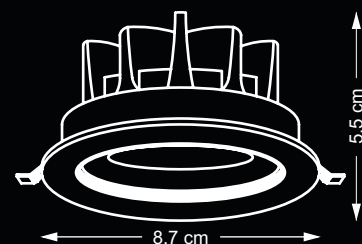

12 W

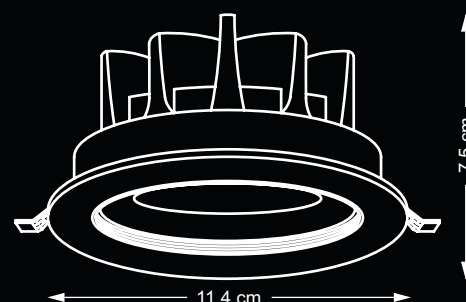

18 W & 25 W

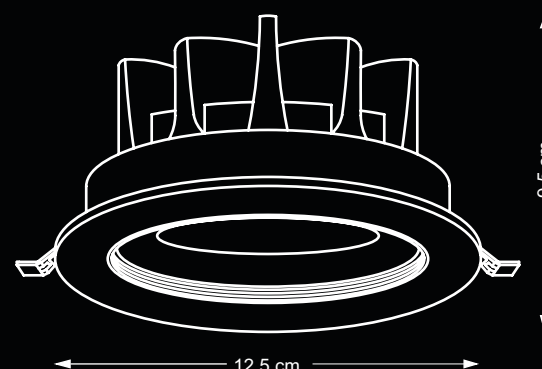

ITEM CODE	WATTAGE	CCT	DIMENSIONS (in cms)	LUMENS	CRI	IP RATING	SURGE RATING (KV)	INPUT VOLTAGE (AC)	BEAM ANGLE
DL072381V	7W	3000K	A- Ø8.7 B- Ø7.5 C- 5.5	550	80	20	≥2.5	220 V AC - 240 V AC	30°
DL073381V	7W	4000K	A- Ø8.7 B- Ø7.5 C- 5.5	575	80	20	≥2.5	220 V AC - 240 V AC	30°
DL122381V	12W	3000K	A- Ø11.4 B- Ø9.5 C- 7.5	960	80	20	≥2.5	220 V AC - 240 V AC	30°
DL123381V	12W	4000K	A- Ø11.4 B- Ø9.5 C- 7.5	1080	80	20	≥2.5	220 V AC - 240 V AC	30°
DL182381V	18W	3000K	A- Ø12.5 B- Ø12.0 C- 9.5	1440	80	20	≥2.5	220 V AC - 240 V AC	30°
DL183381V	18W	4000K	A- Ø12.5 B- Ø12.0 C- 9.5	1620	80	20	≥2.5	220 V AC - 240 V AC	30°
DL252381V	25W	3000K	A- Ø12.5 B- Ø12.0 C- 9.5	2000	80	20	≥2.5	220 V AC - 240 V AC	30°
DL253381V	25W	4000K	A- Ø12.5 B- Ø12.0 C- 9.5	2125	80	20	≥2.5	220 V AC - 240 V AC	30°

Dimensions: A- LHW/Diameter | B- Cut Out Size | C- Height

LED COB DOWNLIGHTERS

DESCRIPTION

Recessed Mounted Round Downlighters. Unique combination of high output and low glare. Precisely designed heat sink ensures faster heat dissipation and thus better life and improved performance

Slim design gels perfectly with clean ceiling to get a sophisticated and contemporary look.

Excellent colour consistency throughout the installation

MATERIAL OF CONSTRUCTION

Aluminium

TECHNICAL INFORMATION

Wattage:
Galaxy pro- 7W, 12W, 18W & 25W
GVO- 6W & 12W

CRI: ≥80, for better light quality

SDCM:
Galaxy pro- ≤7
GVO- ≤3

Input Voltage: 220 V AC - 240 V AC

Surge Protection: ≥2.5KV

IP Rating: IP20

Life: ≥30,000 burning hours

Dimmability: Standard Dimmable in GVO 12W. Please get in touch with Tisva Team for other Dimming Options

APPLICATION AREA

Residences | Art Galleries | Retail | Museums | Modern Offices

GVO

LED COB DOWNLIGHTERS

6 W

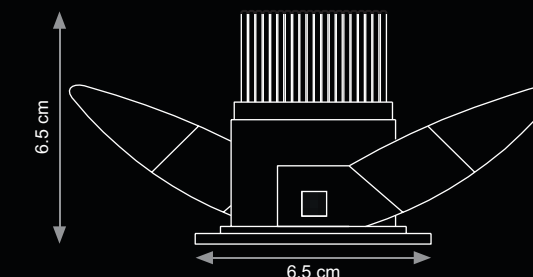
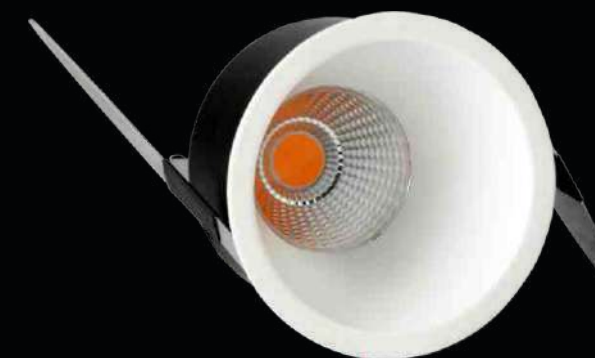

12 W

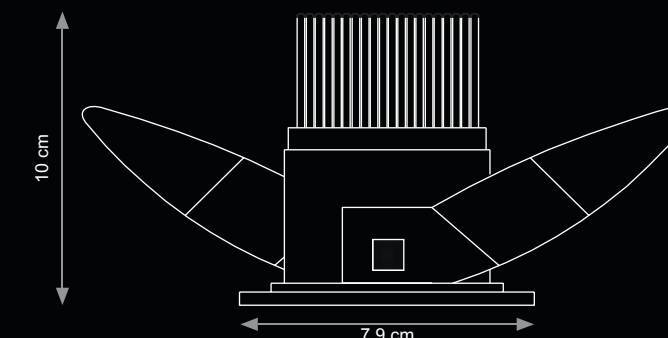
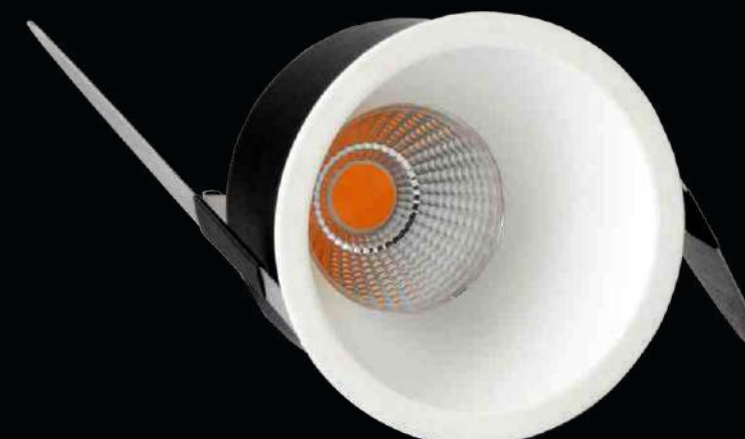

ITEM CODE	WATTAGE	CCT	DIMENSIONS (in cms)	LUMENS	CRI	IP RATING	SURGE RATING (KV)	INPUT VOLTAGE (AC)	BEAM ANGLE
DL6W40D3KN	6 W	3000 K	A - 6.4 B - 6.5	550	>80	20	≥2.5kV	220 V AC - 240 V AC	40°
DL6W40D4KN	6 W	4000 K	A - 6.4 B - 6.5	570	>80	20	≥2.5kV	220 V AC - 240 V AC	40°
DL12W38D3K	12 W	3000 K	A - 7.9 B - 10.0	950	>80	20	≥2.5kV	220 V AC - 240 V AC	38°
DL12W38D4K	12 W	4000 K	A - 7.9 B - 10.0	980	>80	20	≥2.5kV	220 V AC - 240 V AC	38°

Dimensions: A- LHW/Diameter | B- Cut Out Size | C- Height

JENO

LOW GLARE
FOR BETTER
EYE COMFORT

SDCM<4
FOR BETTER
COLOUR
CONSISTENCY

HIGH LIGHT
OUTPUT

UBER MODERN
&
SLEEK DESIGN

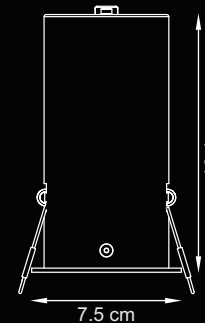
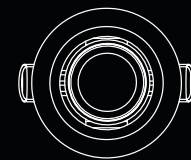
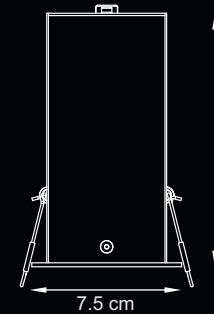
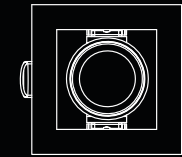

ITEM CODE	WATTAGE	CCT	DIMENSIONS (in cms)	LUMENS	CRI	IP RATING	SURGE RATING (kV)	INPUT VOLTAGE (AC)	BEAM ANGLE
DLB20905	7.5 W	3000 K	A - 7.5 H 7.5 B - 13.1 C - 6.5 H 6.5	450	≥ 80	20	≥ 2.5	220 V AC - 240 V AC	24°
DLB20904	7.5 W	3000 K	A - Ø7.2 B - Ø12.8 C - Ø6.5	450	≥ 80	20	≥ 2.5	220 V AC - 240 V AC	24°

Dimensions: A- LHW/Diameter | B- Cut Out Size | C- Height

LED COB
DOWNLIGHTERS

DESCRIPTION

Recessed Mounted Downlighters.
Unique combination of high output and
very low glare.

Slim design gels perfectly with clean
ceiling to get a sophisticated and
contemporary look.

Jeno offers 360 degree rotational
ability to focus on artworks, features etc.

MATERIAL OF CONSTRUCTION

Aluminium

TECHNICAL INFORMATION

Wattage:

JENO - 7.5W
LINOS - 3W

CRI:

≥80, For Better Light
Quality

SDCM:

≤4, Ensures Better
Colour Consistency

Input Voltage: 220 V AC - 240 V AC

Surge

Protection: ≤2.5kv

IP Rating:

IP20

Life:

≥30,000 Burning Hours

Dimmability:

On Request. Please get
in touch with Tisva Team
for Dimming Options

APPLICATION AREA

Residences | Art Galleries | Retail |
Museums | Modern Offices

LED COB
DOWNLIGHTERS

LINOS

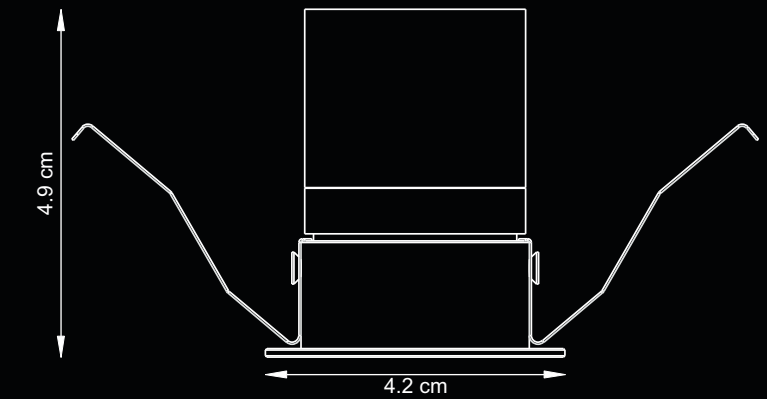

ITEM CODE	WATTAGE	CCT	DIMENSIONS (in cms)	LUMENS	CRI	IP RATING	SURGE RATING (kV)	INPUT VOLTAGE (AC)	BEAM ANGLE
DL320905	3 W	3000 K	A - Ø4.2 B - Ø3.8 C - 4.9	180	≥ 80	20	≥ 2.5	220 V AC - 240 V AC	15°

Dimensions: A- LHW/Diameter | B- Cut Out Size | C- Height

UENZA PRO

DIE CAST ALUMINIUM HOUSING

WIDE WATTAGE RANGE

LINEAR COB FIXTURE

LOW GLARE

SLEEK DESIGN FOR CLEAN CEILINGS



3W

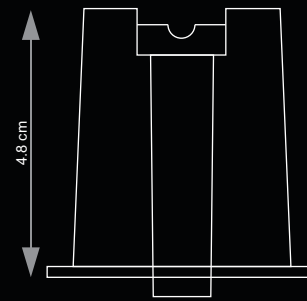
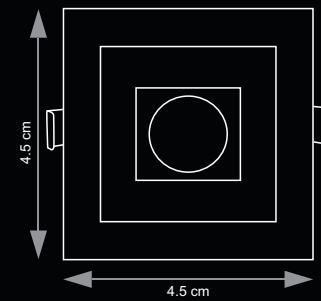

5W

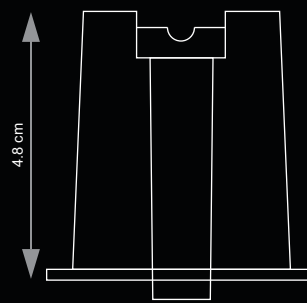
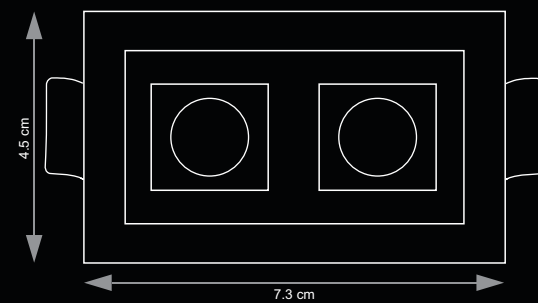

UENZA PRO

DESCRIPTION

The Linear Cob LED is a sophisticated low ceiling product. Clean and minimal, they are the perfect solution for areas that require clean ceilings.

Highly efficient and with low UGR ensures a superior eye comfort

Available in various configuration of modules and wattage

MATERIAL OF CONSTRUCTION

Die Cast Powder Coated Aluminum housing with SS Mounting Clips

TECHNICAL INFORMATION

- Wattage:** 3W, 5W
- CRI:** ≥80, For Better Light Quality
- SDCM:** ≤4, ensures better colour consistency
- Input Voltage:** 220 V AC - 240 V AC
- Surge Protection:** ≤2.5KV
- IP Rating:** IP 20,
- Life:** ≥30,000 burning hours
- Dimmability:** On Request. Please get in touch with Tisva Team for Dimming Options

APPLICATION AREA

Offices | Conference Halls | Hotels | Showrooms | Residences

LINEAR COB DOWNLIGHTERS

LUMINOUS INTENSITY DISTRIBUTION CURVE

3W

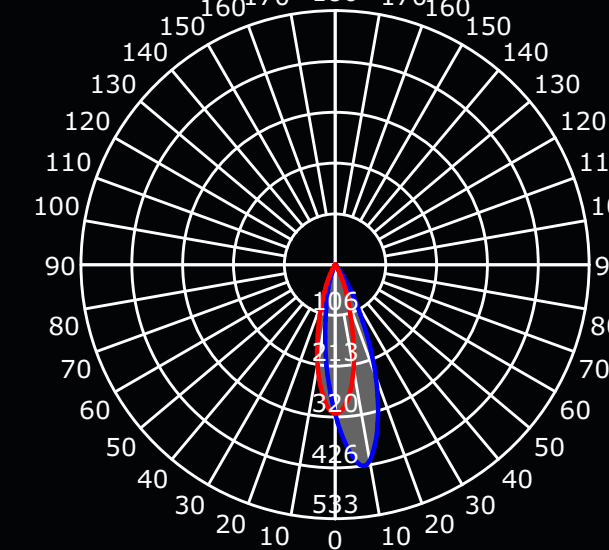

5W

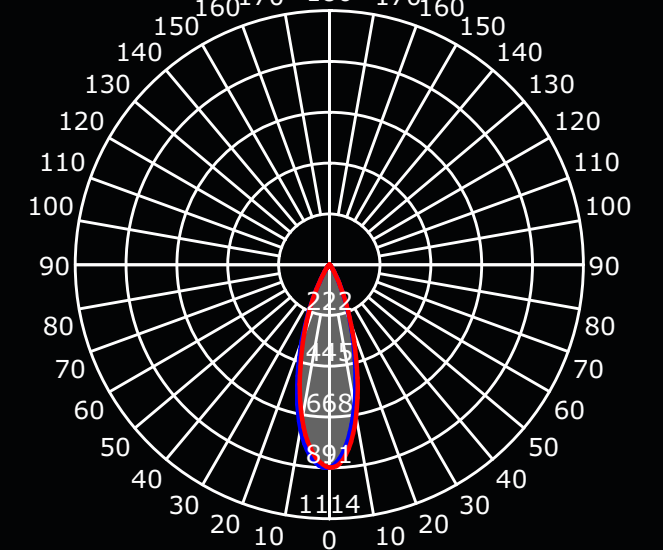

AVERAGE ILLUMINANCE AT A DISTANCE

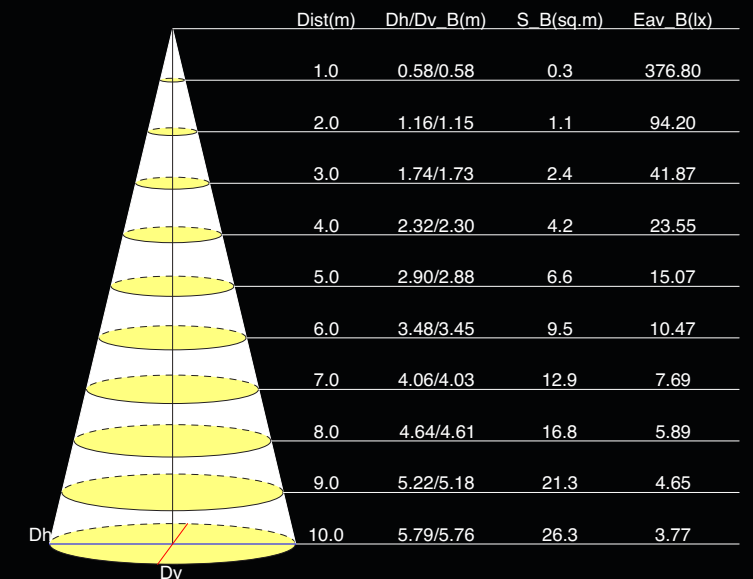
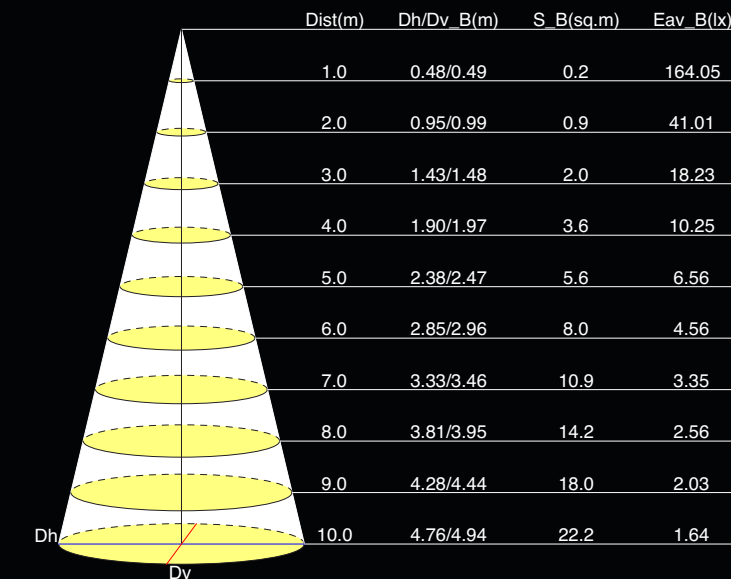

ITEM CODE	WATTAGE	CCT	DIMENSIONS (in cms)	LUMEN	BEAM ANGLE
DL3257012	3 W	3000 K	A - 4.5L H 4.5W B - 3.8L H 3.8W C - 4.8	150	32°
DL3357013	3 W	4000 K	A - 4.5L H 4.5W B - 3.8L H 3.8W C - 4.8	155	32°
DL5257022	5 W	3000 K	A - 7.3L H 4.5W B - 6.6L H 3.8W C - 4.8	300	28°
DL5357023	5 W	4000 K	A - 7.3L H 4.5W B - 6.6L H 3.8W C - 4.8	310	28°

Dimensions: A- LHW/Diameter | B- Cut Out Size | C- Height

UENZA PRO

- DIE CAST ALUMINIUM HOUSING
- WIDE WATTAGE RANGE
- LINEAR COB FIHTURE
- LOW GLARE
- SLEEK DESIGN FOR CLEAN CEILINGS



UENZA PRO

DESCRIPTION

The Linear Cob LED is a sophisticated low ceiling product. Clean and minimal, they are the perfect solution for areas that require clean ceilings.

Highly efficient and with low glare ensures a superior eye comfort

Available in various configuration of modules and wattage

MATERIAL OF CONSTRUCTION

Die Cast Powder Coated Aluminum housing with SS Mounting Clips

TECHNICAL INFORMATION

- Wattage:** 13W & 30W
- CRI:** ≥80, For Better Light Quality
- SDCM:** ≤4, ensures superb colour consistency
- Input Voltage:** 220 V AC - 240 V AC
- Surge Protection:** ≤2.5KV
- IP Rating:** IP 20,
- Life:** ≥30,000 burning hours
- Dimmability:** On Request. Please get in touch with Tisva Team for Dimming Options

APPLICATION AREA

Offices | Conference Halls | Hotels | Showrooms | Residences

13W

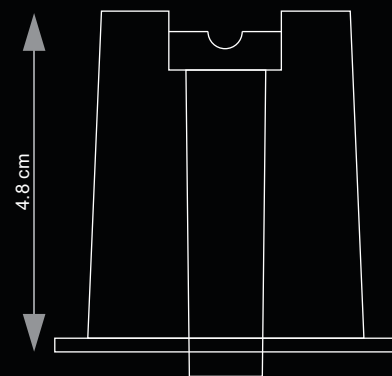
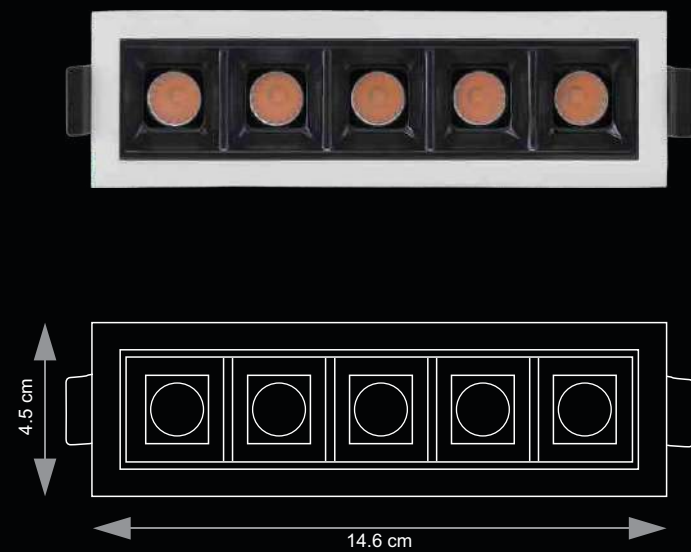

30W

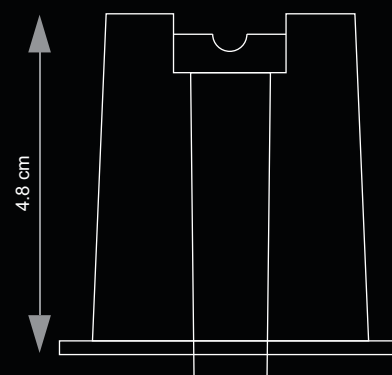

LINEAR COB DOWNLIGHTERS

LUMINOUS INTENSITY DISTRIBUTION CURVE

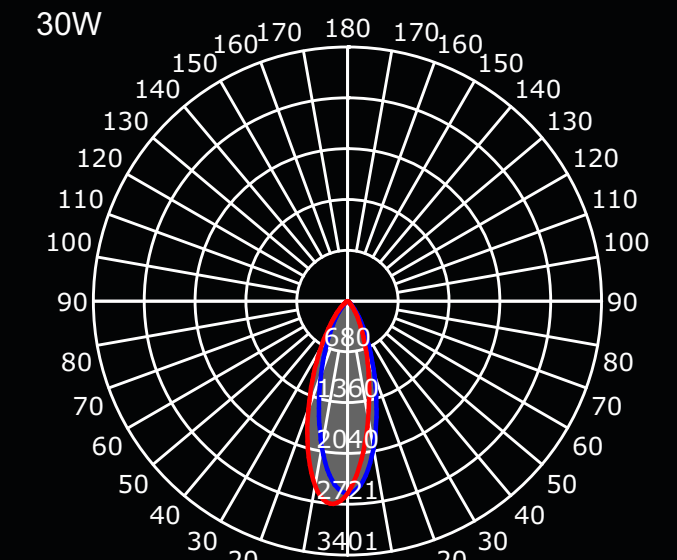
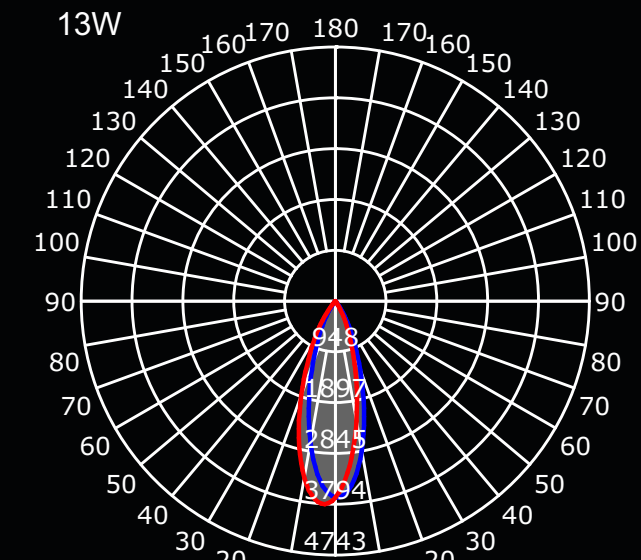

AVERAGE ILLUMINANCE AT A DISTANCE

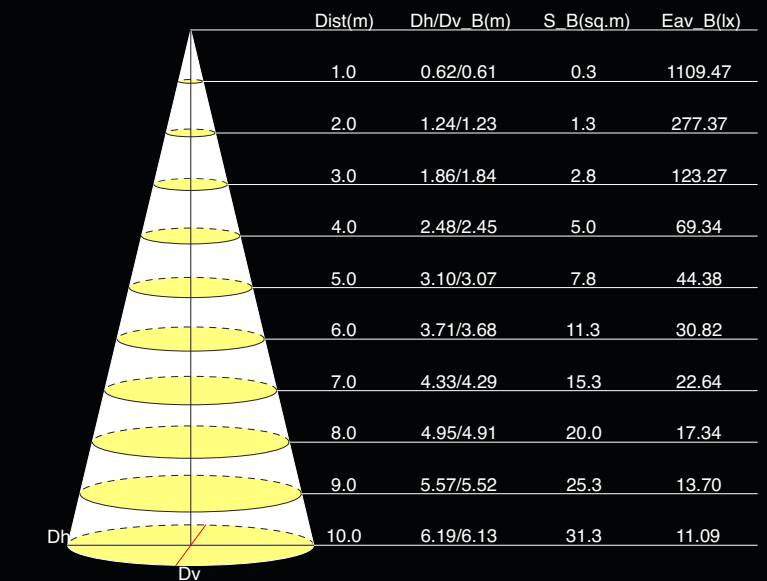
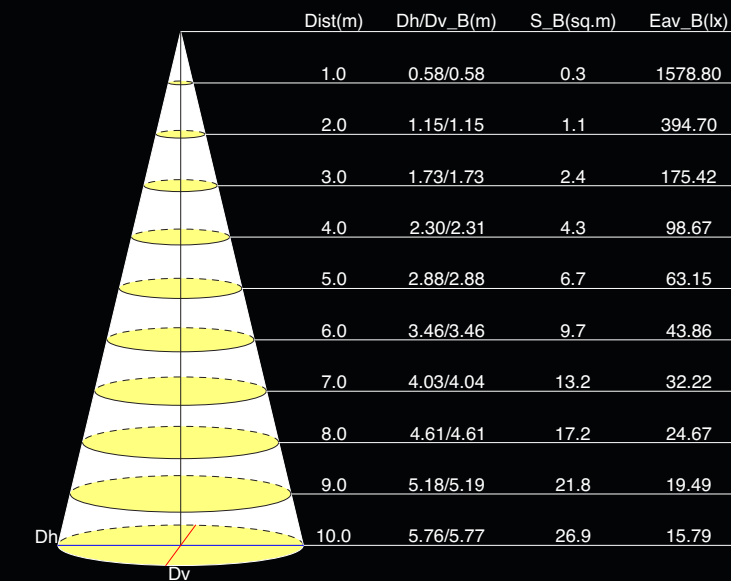

ITEM CODE	WATTAGE	CCT	DIMENSIONS (in cms)	LUMEN	BEAM ANGLE
DL1325705	13 W	3000 K	A - 14.6L H 4.5W B - 14L H 3.8W C - 4.8	750	32°
DL1335705	13 W	4000 K	A - 14.6L H 4.5W B - 14L H 3.8W C - 4.8	780	32°
DL3025710	30 W	3000 K	A - 28.0L H 4.5W B - 27.0L H 3.8W C - 4.8	1650	32°
DL3035710	30 W	4000 K	A - 28.0L H 4.5W B - 27.0L H 3.8W C - 4.8	1720	32°

UENZA 180

- DIE CAST ALUMINIUM HOUSING
- LINEAR COB WALL WASHER
- ZERO LEVEL WALL WASH
- UNIFORM WALL WASH
- SLEEK DESIGN FOR CLEAN CEILINGS

13W

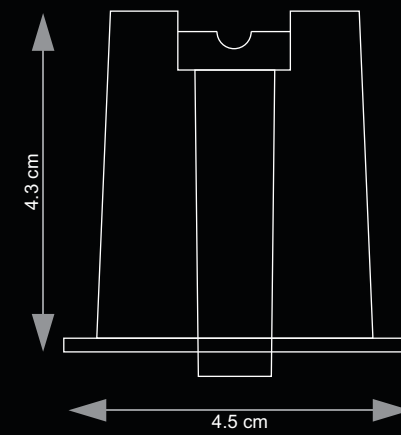
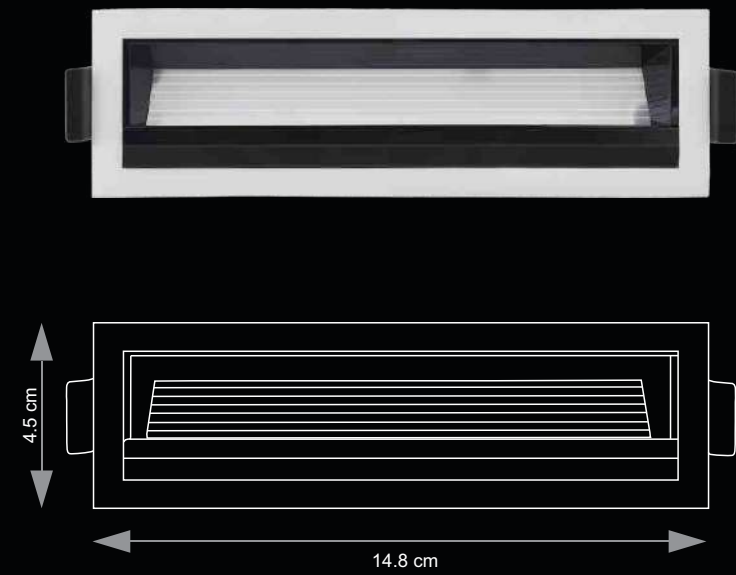

25W

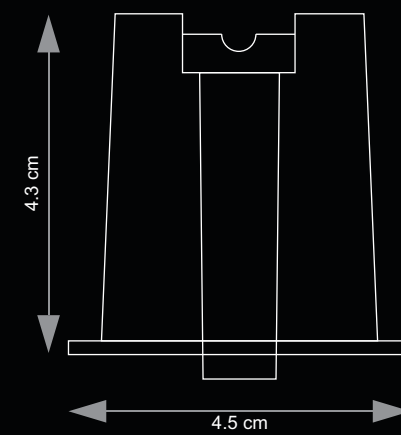
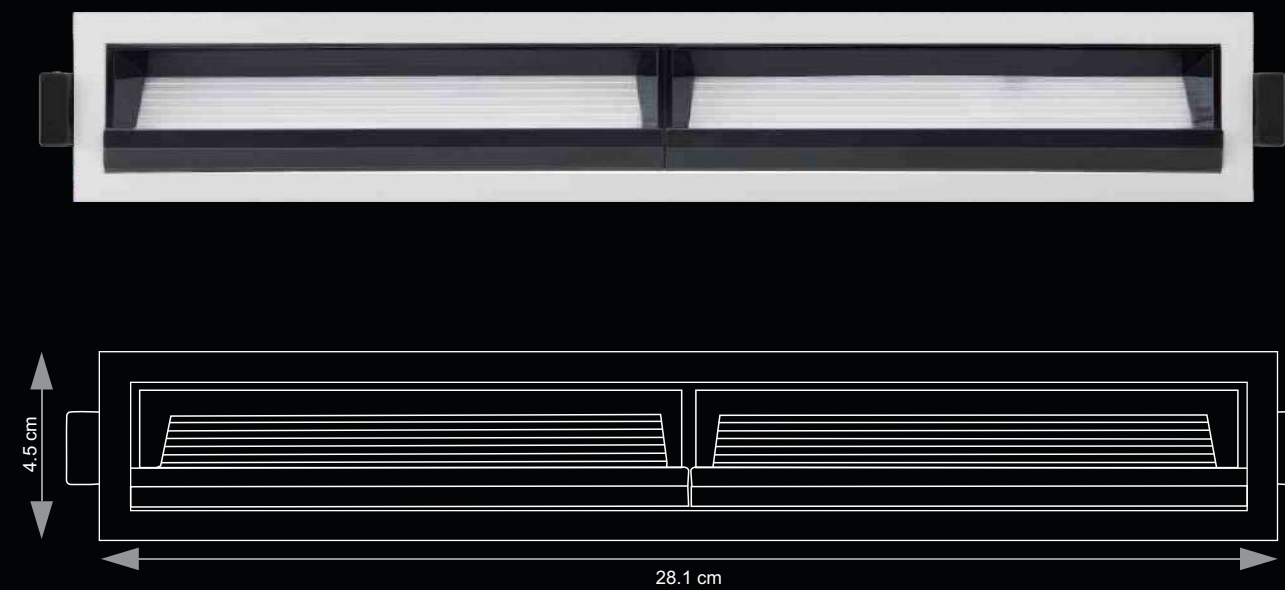

UENZA 180

DESCRIPTION

The Linear Cob Wall Washer provides uniform and zero level wall wash, that is ideal for accentuating paintings, works of art or feature walls.

Clean and minimal, they are perfect for achieving clean ceilings.

MATERIAL OF CONSTRUCTION

Die Cast Powder Coated Aluminum housing with SS Mounting Clips

TECHNICAL INFORMATION

- Wattage:** 13W & 30W
- CRI:** ≥80, For Better Light Quality
- SDCM:** ≤3, ensures better colour consistency
- Input Voltage:** 220 V AC - 240 V AC
- Surge Protection:** ≤2.5KV
- IP Rating:** IP 20,
- Life:** ≥30,000 burning hours
- Dimmability:** On Request. Please get in touch with Tisva Team for Dimming Options

APPLICATION AREA

Wall Washing applications like highlighting feature walls, paintings, works of art, etc.

LINEAR COB WALL WASHER

LUMINOUS INTENSITY DISTRIBUTION CURVE

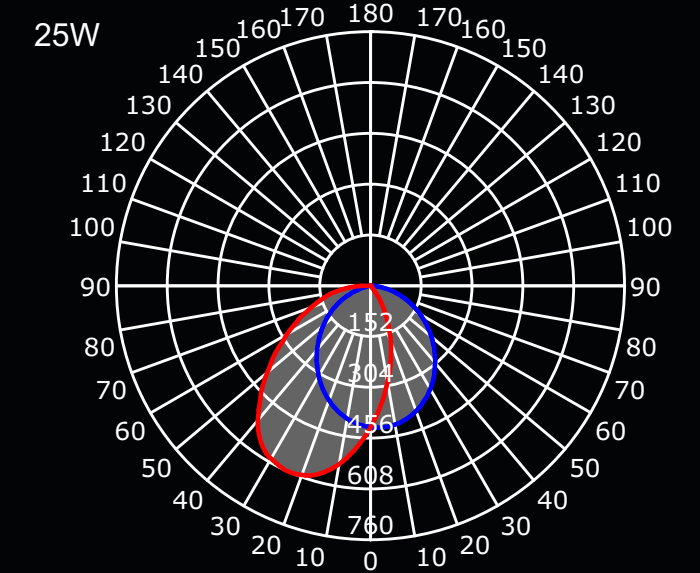
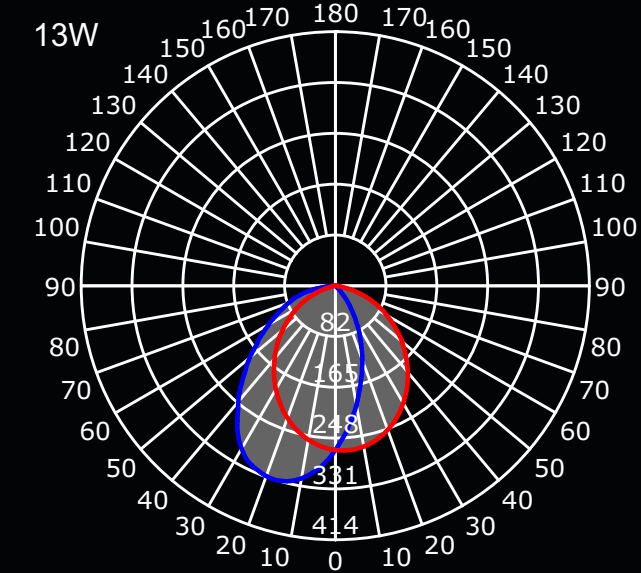

AVERAGE ILLUMINANCE AT A DISTANCE

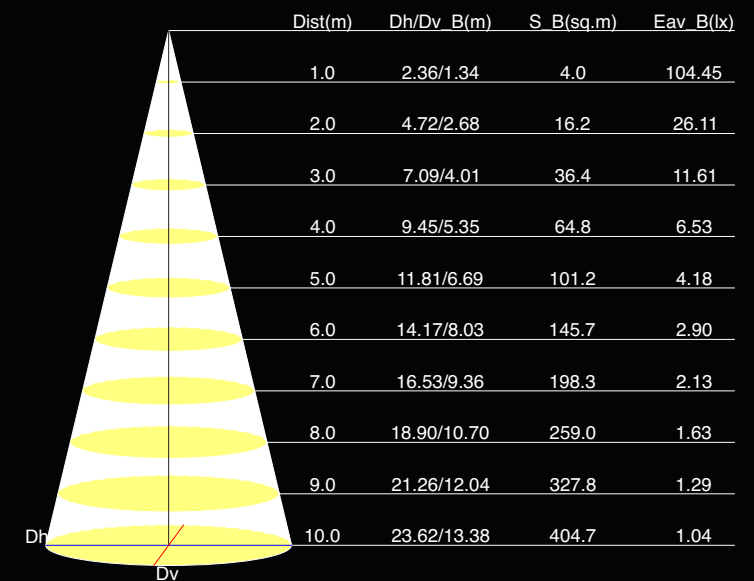
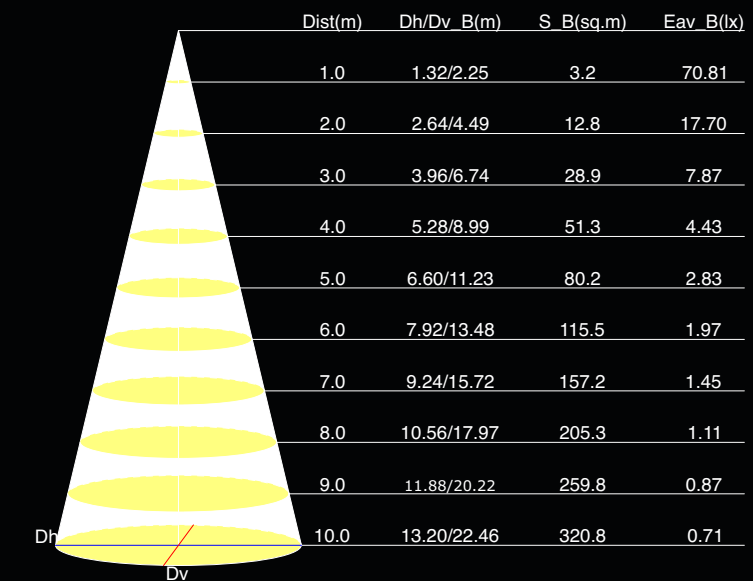

ITEM CODE	WATTAGE	CCT	DIMENSIONS (in cms)	LUMEN	BEAM ANGLE
DL13W3K02R	13 W	3000 K	A - 14.8L H 4.5W B - 14L H 3.7W C - 4.3	715	100°
DL13W4K02R	13 W	4000 K	A - 14.8L H 4.5W B - 14L H 3.7W C - 4.3	750	100°
DL25W3K02R	25 W	3000 K	A - 28.1L H 4.5W B - 27.5L H 3.7W C - 4.3	1370	100°
DL25W4K02R	25 W	4000 K	A - 28.1L H 4.5W B - 27.5L H 3.7W C - 4.3	1430	100°

Dimensions: A- LHW/Diameter | B- Cut Out Size | C- Height

VENZA ULTRA SLIM

DIE CAST ALUMINIUM HOUSING

CRI>=90

SUPER SLIM DESIGN

UGR<13

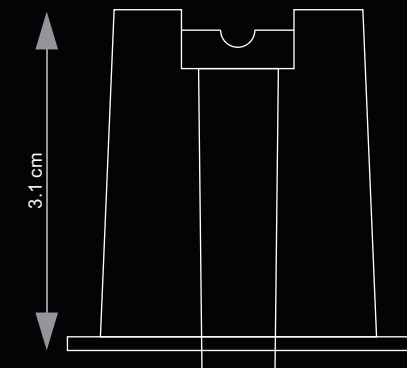
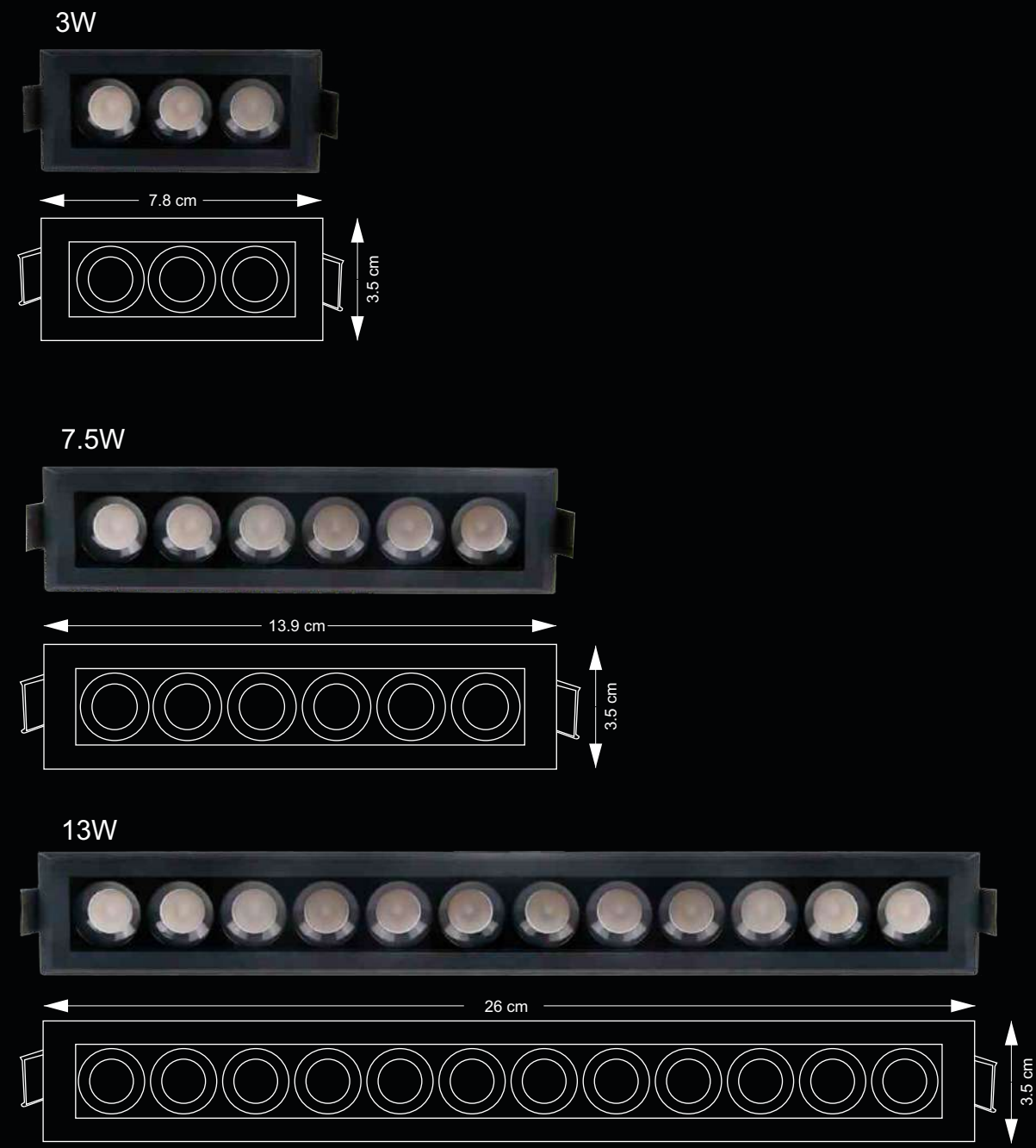

ITEM CODE	WATTAGE	CCT	DIMENSIONS (in cms)	LUMEN	BEAM ANGLE
DLO333U509	3 W	3000 K	A - 7.8L H 3.5W B - 7L H 2.8W C - 3.1	175	32°
DLO334U509	3 W	4000 K	A - 7.8L H 3.5W B - 7L H 2.8W C - 3.1	185	30°
DLO833U509	7.5 W	3000 K	A - 13.9L H 3.5W B - 13.1L H 2.8W C - 3.1	523	30°
DLO834U509	7.5 W	4000 K	A - 13.9L H 3.5W B - 13.1L H 2.8W C - 3.1	550	30°
DL1333U509	13 W	3000 K	A - 26L H 3.5W B - 25.1L H 2.8W C - 3.1	975	30°
DL1334U509	13 W	4000 K	A - 26L H 3.5W B - 25.1L H 2.8W C - 3.1	1020	30°

VENZA ULTRA SLIM SIGNATURE SERIES

DESCRIPTION

Ultra slim linear COB downlighter. Superb quality of Light with best in class colour rendering properties coupled with excellent colour consistency. A very Low UGR makes this state of the art product ideal for any contemporary space, be it residence or office.

MATERIAL OF CONSTRUCTION

Die Cast Powder Coated Aluminum housing with SS Mounting Clips

TECHNICAL INFORMATION

- Wattage:** 13W, 7,5W & 13W
- CRI:** ≥90, For Better Light Quality
- SDCM:** ≤3, ensures better colour consistency
- Input Voltage:** 220 V AC - 240 V AC
- Surge Protection:** ≤2.5KV
- IP Rating:** IP 20,
- Life:** ≥50,000 burning hours
- Dimmability:** On Request. Please get in touch with Tisva Team for Dimming Options

APPLICATION AREA

Offices | Conference Halls | Hotels | Showrooms | Residences

SLIM LINEAR COB DOWNLIGHTER

LUMINOUS INTENSITY DISTRIBUTION CURVE

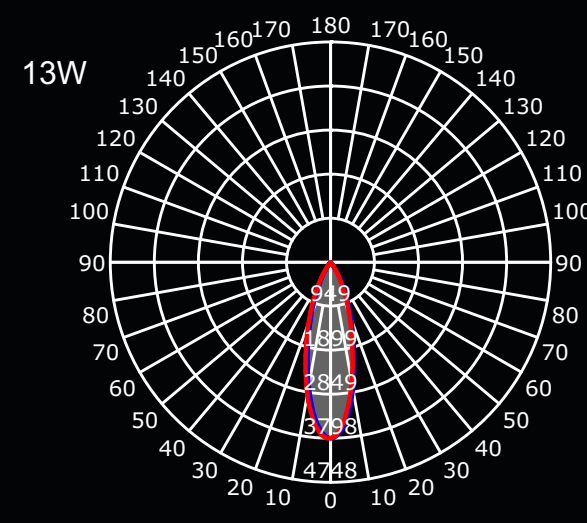
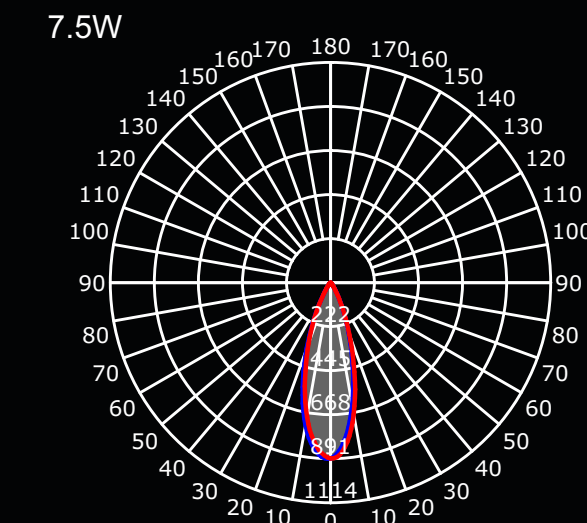
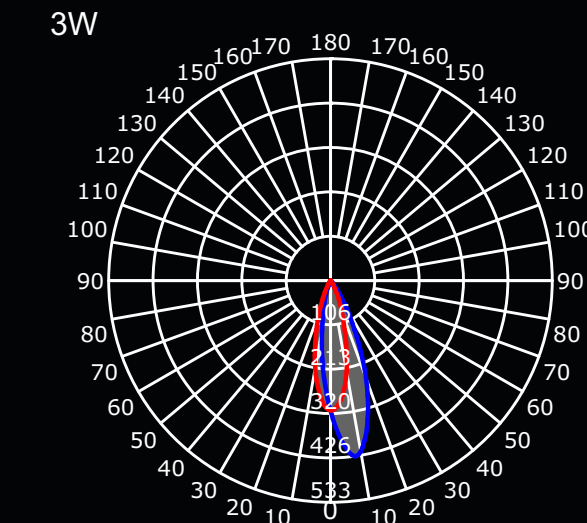

AVERAGE ILLUMINANCE AT A DISTANCE

Dist(m)	Dh/Dv B(m)	S_B(sq.m)	Eav_B(lx)
1.0	0.48/0.49	0.2	164.05
2.0	0.95/0.99	0.9	41.01
3.0	1.43/1.48	2.0	18.23
4.0	1.90/1.97	3.6	10.25
5.0	2.38/2.47	5.6	6.56
6.0	2.85/2.96	8.0	4.56
7.0	3.33/3.46	10.9	3.35
8.0	3.81/3.95	14.2	2.56
9.0	4.28/4.44	18.0	2.03
10.0	4.76/4.94	22.2	1.64

Dist(m)	Dh/Dv B(m)	S_B(sq.m)	Eav_B(lx)
1.0	0.58/0.58	0.3	376.80
2.0	1.16/1.15	1.1	94.20
3.0	1.74/1.73	2.4	41.87
4.0	2.32/2.30	4.2	23.55
5.0	2.90/2.88	6.6	15.07
6.0	3.48/3.45	9.5	10.47
7.0	4.06/4.03	12.9	7.69
8.0	4.64/4.61	16.8	5.89
9.0	5.22/5.18	21.3	4.65
10.0	5.79/5.76	26.3	3.77

Dist(m)	Dh/Dv B(m)	S_B(sq.m)	Eav_B(lx)
1.0	0.54/0.55	0.2	1616.16
2.0	1.09/1.10	0.9	404.04
3.0	1.63/1.65	2.1	179.57
4.0	2.18/2.20	3.8	101.01
5.0	2.72/2.74	5.9	64.65
6.0	3.27/3.29	8.5	44.89
7.0	3.81/3.84	11.5	32.98
8.0	4.35/4.39	15.0	25.25
9.0	4.90/4.94	19.0	19.95
10.0	5.44/5.49	23.5	16.16

Dimensions: A- LHW/Diameter | B- Cut Out Size | C- Height

RIO SF SHORT HEIGHT

- LOW GLARE FOR BETTER EYE COMFORT
- SDCM≤ 3 FOR BETTER COLOUR CONSISTENCY
- HIGH LIGHT OUTPUT
- UBER MODERN & SLEEK DESIGN

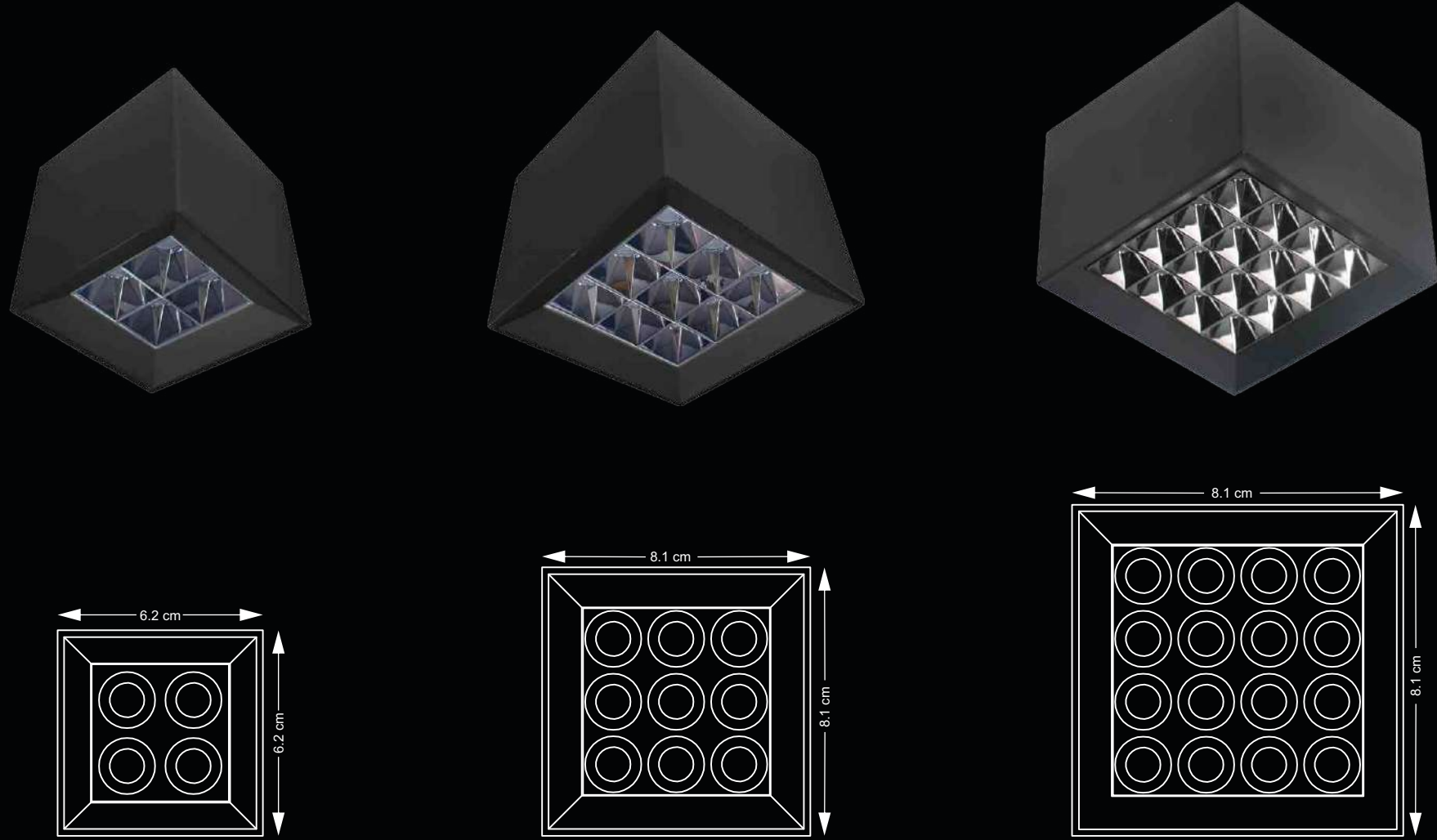
ITEM CODE	WATTAGE	CCT	DIMENSIONS (in cms)	LUMENS	CRI	IP RATING	INPUT VOLTAGE	BEAM ANGLE
DL0635HSQ	6 W	3000K	L - 6.2 W - 6.2 H - 6.2	420 LM	≥ 80	20	220 V AC - 240 V AC	40°
DL0645HSQ	6 W	4000K	L - 6.2 W - 6.2 H - 6.2	440 LM	≥ 80	20	220 V AC - 240 V AC	40°
DL1235HSQ	12 W	3000K	L - 8.1 W - 8.1 H - 8.1	940 LM	≥ 80	20	220 V AC - 240 V AC	40°
DL1245HSQ	12 W	4000K	L - 8.1 W - 8.1 H - 8.1	980 LM	≥ 80	20	220 V AC - 240 V AC	40°
DL1835HSQ	18 W	3000K	L - 10 W - 10 H - 7	1440 LM	≥ 80	20	220 V AC - 240 V AC	40°
DL1845HSQ	18 W	4000K	L - 10 W - 10 H - 7	1500 LM	≥ 80	20	220 V AC - 240 V AC	40°

Dimensions: D- Diameter | W - Width

RIO SF SIGNATURE SERIES

DESCRIPTION

Surface Mounted square Downlighters. Unique combination of high output and very low glare.

Slim design gels perfectly with clean ceiling to get a sophisticated and contemporary look.

Excellent colour consistency throughout the installation

MATERIAL OF CONSTRUCTION

Aluminium

TECHNICAL INFORMATION

- Wattage:** 6W, 12W & 18W
- CRI:** ≥ 80 , For Better Light Quality
- SDCM:** ≤ 3 , ensures better colour consistency
- Input Voltage:** 220 V AC - 240 V AC
- Surge Protection:** $\leq 2.5KV$
- IP Rating:** IP 20,
- Life:** $\geq 30,000$ burning hours
- Dimmability:** On Request. Please get in touch with Tisva Team for Dimming Options

APPLICATION AREA

Residences | Art Galleries | Retail | Museums | Modern Offices

SURFACE MOUNTED SQUARE DOWNLIGHTER

LUMINOUS INTENSITY DISTRIBUTION CURVE

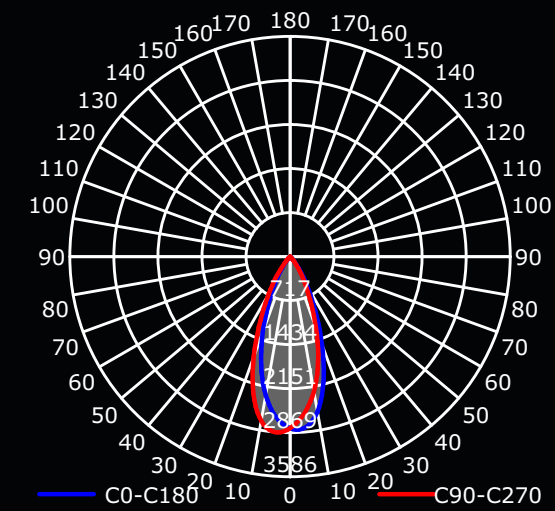
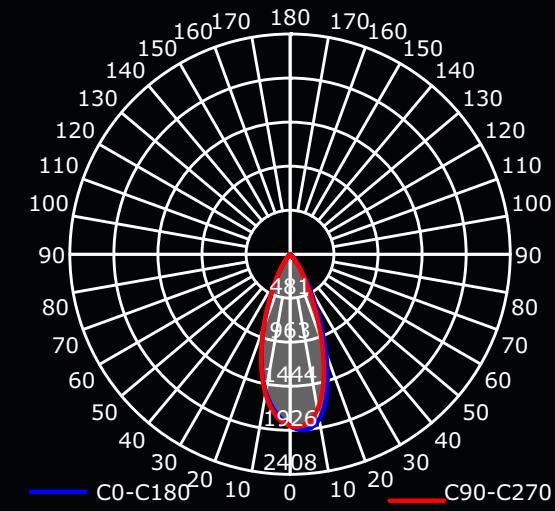
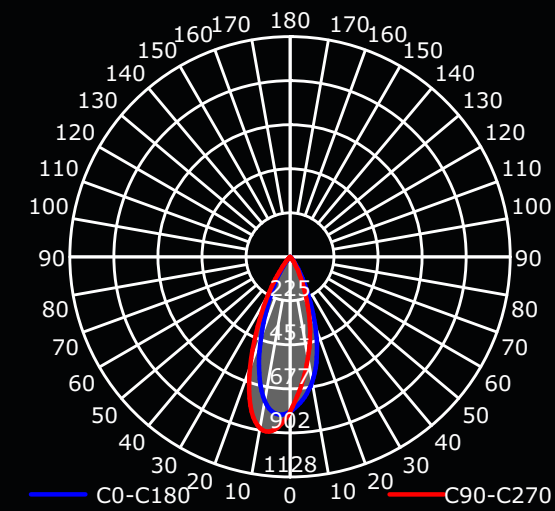

AVERAGE ILLUMINANCE AT A DISTANCE

Dist(m)	Dh/Dv, B(m)	S, B(sq.m)	Eav, B(lx)
1.0	0.73/0.66	0.4	344.38
2.0	1.45/1.32	1.6	86.09
3.0	2.18/1.98	3.7	38.26
4.0	2.91/2.64	6.6	21.52
5.0	3.64/3.30	10.3	13.78
6.0	4.36/3.96	14.8	9.57
7.0	5.09/4.61	20.1	7.03
8.0	5.82/5.27	26.3	5.38
9.0	6.55/5.93	33.3	4.25
10.0	7.27/6.59	41.1	3.44

Dist(m)	Dh/Dv, B(m)	S, B(sq.m)	Eav, B(lx)
1.0	0.74/0.72	0.4	776.54
2.0	1.48/1.44	1.7	194.14
3.0	2.22/2.16	3.8	86.28
4.0	2.96/2.88	6.8	48.53
5.0	3.70/3.60	10.6	31.06
6.0	4.44/4.31	15.3	21.57
7.0	5.18/5.03	20.8	15.85
8.0	5.92/5.75	27.1	12.13
9.0	6.65/6.47	34.3	9.59
10.0	7.39/7.19	42.4	7.77

Dist(m)	Dh/Dv, B(m)	S, B(sq.m)	Eav, B(lx)
1.0	0.73/0.74	0.4	1155.86
2.0	1.45/1.48	1.7	288.97
3.0	2.18/2.22	3.9	128.43
4.0	2.91/2.96	6.9	72.24
5.0	3.63/3.70	10.8	46.23
6.0	4.36/4.44	15.5	32.11
7.0	5.09/5.19	21.1	23.59
8.0	5.81/5.93	27.6	18.06
9.0	6.54/6.67	34.9	14.27
10.0	7.27/7.41	43.1	11.56

Dimensions: A- LHW/Diameter | B- Cut Out Size | C- Height

RIO SF ROUND

- LOW GLARE FOR BETTER EYE COMFORT
- SDCM<3 FOR BETTER COLOUR CONSISTENCY
- HIGH LIGHT OUTPUT
- UBER MODERN & SLEEK DESIGN



ITEM CODE	WATTAGE	CCT	DIMENSIONS (in cms)	COLOUR	LUMENS	CRI	IP RATING	INPUT VOLTAGE	BEAM ANGLE
DL061101	6 W	3000K	D -5.5 H - 8.6	WHITE	500 LM	≥80	20	220 V AC - 240 V AC	30°
DL063101	6 W	4000K	D -5.5 H - 8.6	WHITE	525 LM	≥80	20	220 V AC - 240 V AC	30°
DL0610901	6 W	3000K	D -5.5 H - 8.6	BLACK	500 LM	≥80	20	220 V AC - 240 V AC	30°
DL0630901	6 W	4000K	D -5.5 H - 8.6	BLACK	525 LM	≥80	20	220 V AC - 240 V AC	30°
DL121102	12 W	3000K	D -7.5 H - 11.0	WHITE	900 LM	≥80	20	220 V AC - 240 V AC	30°
DL123102	12 W	4000K	D -7.5 H - 11.0	WHITE	945 LM	≥80	20	220 V AC - 240 V AC	30°
DL1210901	12 W	3000K	D -7.5 H - 11.0	BLACK	900 LM	≥80	20	220 V AC - 240 V AC	30°
DL1230901	12 W	4000K	D -7.5 H - 11.0	BLACK	945 LM	≥80	20	220 V AC - 240 V AC	30°
DL1810901	18 W	3000K	D -9.5 H - 13.0	WHITE	1350 LM	≥80	20	220 V AC - 240 V AC	30°
DL1830901	18 W	4000K	D -9.5 H - 13.0	WHITE	1410 LM	≥80	20	220 V AC - 240 V AC	30°
DL181103	18 W	3000K	D -9.5 H - 13.0	BLACK	1350 LM	≥80	20	220 V AC - 240 V AC	30°
DL183103	18 W	4000K	D -9.5 H - 13.0	BLACK	1410 LM	≥80	20	220 V AC - 240 V AC	30°

Dimensions: D- Diameter | H - Height

RIO SF

RIO SF SQUARE

SURFACE MOUNTED SQUARE DOWNLIGHTER

DESCRIPTION

Surface Mounted Square & Round Downlighters.

Choice of Black, Golden, Chrome Reflector to match with the interiors.

Smooth, Clean Cut design for a sophisticated and contemporary look.

Unique combination of high output and low glare.

Wide range of wattages to choose from.

Excellent colour consistency throughout the installation with superior SDCM Rating

MATERIAL OF CONSTRUCTION

Extruded / Pressure Die Cast Powder Coated Aluminium

TECHNICAL INFORMATION

Wattage: 6W, 12W & 18W

CRI: ≥80, For Better Light Quality

SDCM: ≤3, ensures better colour consistency

Input Voltage: 220 V AC - 240 V AC

Surge Protection: ≤2.5KV

IP Rating: IP 20,

Life: ≥30,000 burning hours

Dimmability: On Request. Please get in touch with Tisva Team for Dimming Options

APPLICATION AREA

Residences | Art Galleries | Retail | Museums | Modern Offices

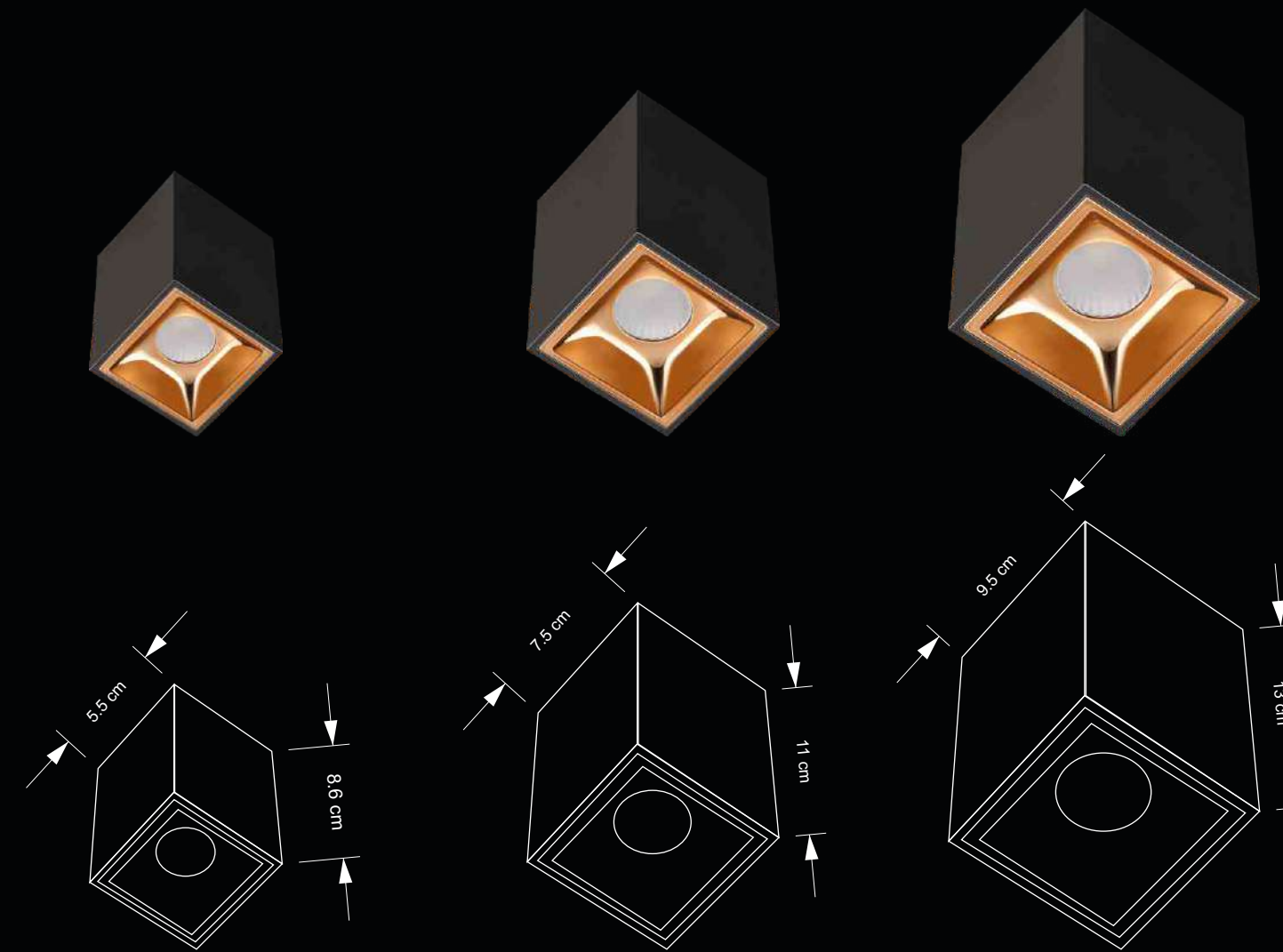

ITEM CODE	WATTAGE	CCT	DIMENSIONS (in cms)	COLOUR	LUMENS	CRI	IP RATING	INPUT VOLTAGE	BEAM ANGLE
DL06291	6 W	3000K	D -5.5 H - 8.6	BLACK	500 LM	≥80	20	220 V AC - 240 V AC	30°
DL06391	6 W	4000K	D -5.5 H - 8.6	BLACK	525 LM	≥80	20	220 V AC - 240 V AC	30°
DL06221	6 W	3000K	D -5.5 H - 8.6	BLACK-GOLD	500 LM	≥80	20	220 V AC - 240 V AC	30°
DL06321	6 W	4000K	D -5.5 H - 8.6	BLACK-GOLD	525 LM	≥80	20	220 V AC - 240 V AC	30°
DL12291	12 W	3000K	D -7.5 H - 11.0	BLACK	900 LM	≥80	20	220 V AC - 240 V AC	30°
DL12391	12 W	4000K	D -7.5 H - 11.0	BLACK	945 LM	≥80	20	220 V AC - 240 V AC	30°
DL12221	12 W	3000K	D -7.5 H - 11.0	BLACK-GOLD	900 LM	≥80	20	220 V AC - 240 V AC	30°
DL12321	12 W	4000K	D -7.5 H - 11.0	BLACK-GOLD	945 LM	≥80	20	220 V AC - 240 V AC	30°
DL18291	18 W	3000K	D -9.5 H - 13.0	BLACK	1424 LM	≥80	20	220 V AC - 240 V AC	30°
DL18391	18 W	4000K	D -9.5 H - 13.0	BLACK	1495 LM	≥80	20	220 V AC - 240 V AC	30°
DL18221	18 W	3000K	D -9.5 H - 13.0	BLACK-GOLD	1424 LM	≥80	20	220 V AC - 240 V AC	30°
DL18321	18 W	4000K	D -9.5 H - 13.0	BLACK-GOLD	1495 LM	≥80	20	220 V AC - 240 V AC	30°

Dimensions: D- Diameter | H - Height



RINGS & LED MODULE

- IVEXCOBRINGS | IVEXPROCOBRINGS | IVEXTRIMLESSCOBRINGS | EAGLECOBRINGS | GIMBALCOBRINGS
- IVEXPRIMELEDMODULE | EAGLELEDMODULE | EAGLEPRO LEDMODULE

Ivex Prime

- DIE CAST ALUMINIUM HOUSING
- SEMI MODULAR DESIGN
- CHOICE OF "RINGS"
-

15W



10W

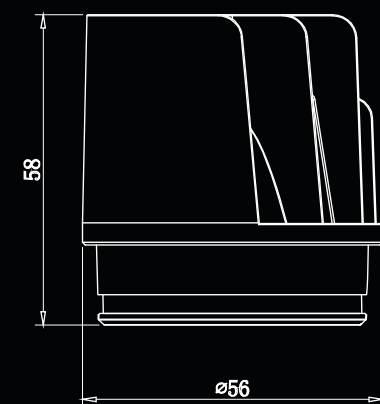
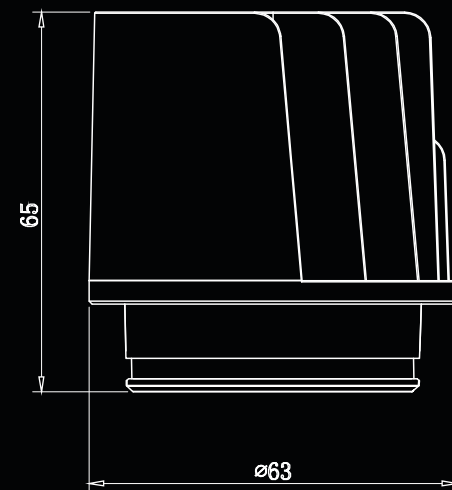
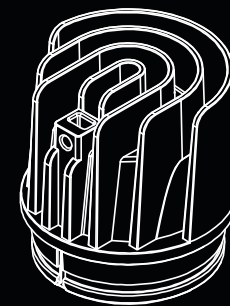
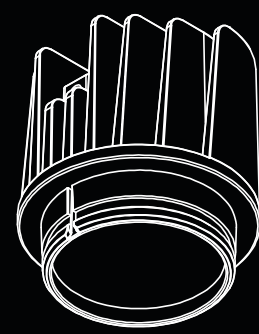
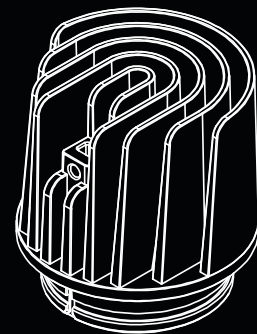

LED MODULE

Ivex Prime

DESCRIPTION

Downlighter Module, Ivex prime is to be used in combination with a suitable Ivex Ring.

Large variety of application specific "Rings" are available with options in Fixed, Adjustable(Tiltable), Wall washer applications.

Choose from a wide colour range of rings to match your interiors

MATERIAL OF CONSTRUCTION

Aluminium Die Cast Housing for better heat dissipation and sturdiness.

TECHNICAL INFORMATION

- Wattage:** 10W & 15W
- CRI:** ≥80, For Better Light Quality
- SDCM:** ≤3, ensures better colour consistency
- Input Voltage:** 220 V AC - 240 V AC
- Surge Protection:** ≤2KV
- IP Rating:** IP 20,
- Life:** ≥30,000 burning hours
- Dimmability:** On Request. Please get in touch with Tisva Team for Dimming Options

APPLICATION AREA

Residences | Modern Work Spaces | Executive Cabins | Hotels | Showrooms

LUMINOUS INTENSITY DISTRIBUTION CURVE

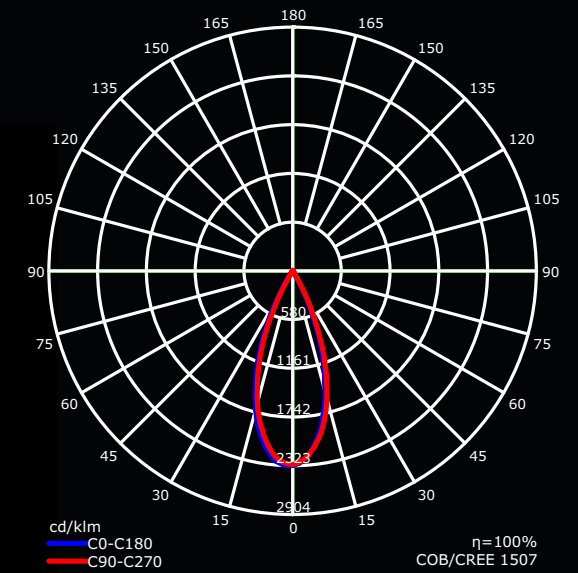
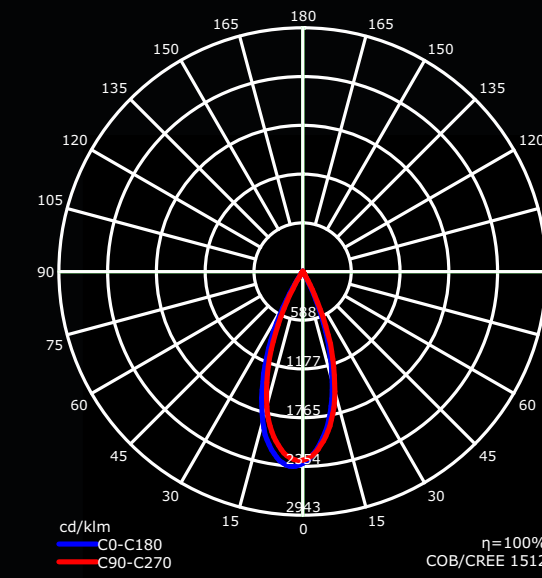

AVERAGE ILLUMINANCE AT A DISTANCE

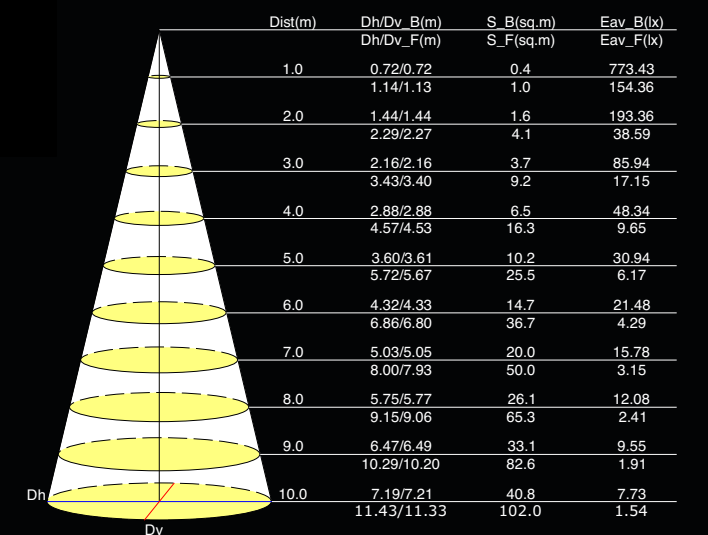
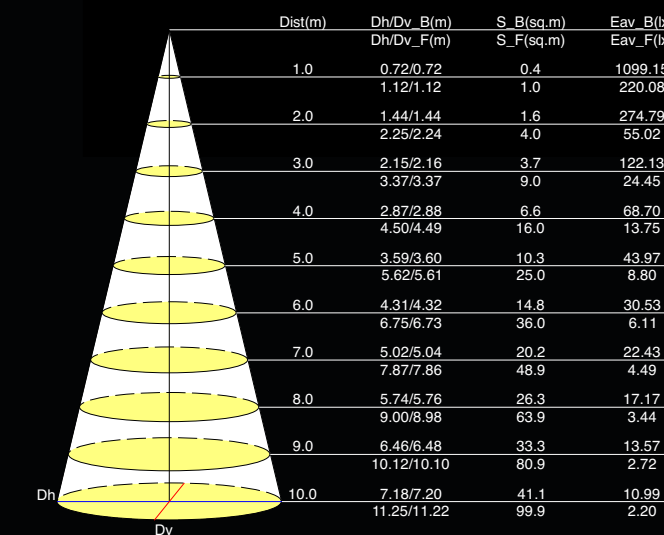

ITEM CODE	WATTAGE	CCT	DIMENSIONS (in cms)	LUMENS	CRI	DIMMABLE	IP RATING	SURGE RATING (KV)	INPUT VOLTAGE (AC)	BEAM ANGLE
DL1011211A	10W	2700K	A - Ø5.6 C - 5.8	820	≥ 80	Yes	20	≤2.0	220 V AC- 240 V AC	38°
DL1031211A	10W	4000K	A - Ø5.6 C - 5.8	860	≥ 80	Yes	20	≤2.0	220 V AC- 240 V AC	38°
DL1011211N	10W	2700K	A - Ø5.6 C - 5.8	820	≥ 80	No	20	≤2.0	220 V AC- 240 V AC	38°
DL1031211N	10W	4000K	A - Ø5.6 C - 5.8	860	≥ 80	No	20	≤2.0	220 V AC- 240 V AC	38°
DL1511211A	15W	2700K	A - Ø6.3 C - 6.5	1250	≥ 80	Yes	20	≤2.0	220 V AC- 240 V AC	38°
DL1531211A	15W	4000K	A - Ø6.3 C - 6.5	1310	≥ 80	Yes	20	≤2.0	220 V AC- 240 V AC	38°
DL1511211N	15W	2700K	A - Ø6.3 C - 6.5	1250	≥ 80	No	20	≤2.0	220 V AC- 240 V AC	38°
DL1531211N	15W	4000K	A - Ø6.3 C - 6.5	1310	≥ 80	No	20	≤2.0	220 V AC- 240 V AC	38°

IVEX COB RINGS

- DIE CAST ALUMINIUM
- APPLICATION SPECIFIC DESIGNS
- MULTIPLE COLOUR COMBINATIONS
- SUITABLE FOR IVEX & EAGLE MODULES
- TRIMLESS VERSION AVAILABLE

RECESSED TILTABLE

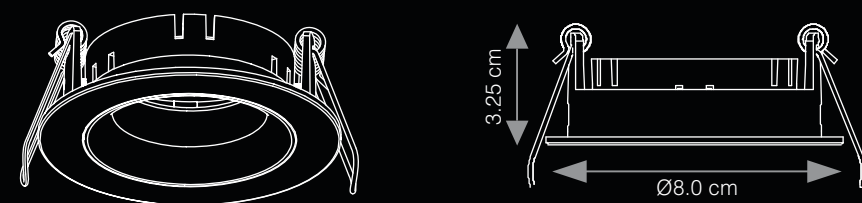

ITEM CODE	COLOR
T-HB463635WC	TRIM : WHITE REFLECTOR : CHROME
T-HB463635WG	TRIM : WHITE REFLECTOR : GOLD
T-HB463635WS	TRIM : WHITE REFLECTOR : SILVER
T-HB463635W	TRIM : WHITE REFLECTOR : WHITE
T-HB463635B	TRIM : BLACK REFLECTOR : BLACK
T-HB463635BG	TRIM : BLACK REFLECTOR : GOLD
T-HB463635WB	TRIM : WHITE REFLECTOR : BLACK

DEEP RECESSED FIXED

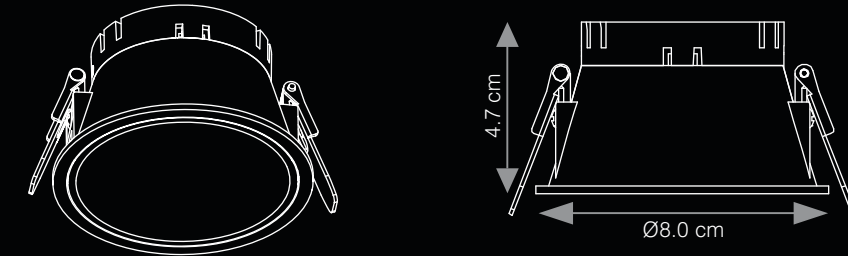

ITEM CODE	COLOR
T-HB46366WC	TRIM : WHITE REFLECTOR : CHROME
T-HB46366WG	TRIM : WHITE REFLECTOR : GOLD
T-HB46366WS	TRIM : WHITE REFLECTOR : SILVER
T-HB46366W	TRIM : WHITE REFLECTOR : WHITE
T-HB46366B	TRIM : BLACK REFLECTOR : BLACK
T-HB46366BG	TRIM : BLACK REFLECTOR : GOLD
T-HB46366WB	TRIM : WHITE REFLECTOR : BLACK

IVEX COB RINGS

DESCRIPTION

Ivox Rings are a combination of Trim and reflector with a variety of Designs

Flexibility of use with different wattage LED modules as per requirement. Suitable for Ivox and Eagle Modules

Choice of Fixed, tiltable, deep recessed & wall washer version

Wide range of colour options of *Trim* and *Reflector* to choose from, to match your interiors

Trimless version available for a cleaner and smoother look

Square version available for select options

MATERIAL OF CONSTRUCTION

Die cast aluminium body with SS mounting clips for ease of mounting & durability

APPLICATION AREA

Residences | Modern Work Spaces | Executive Cabins | Hotels | Showrooms

COB RINGS

WALL WASHER DEEP RECESSED

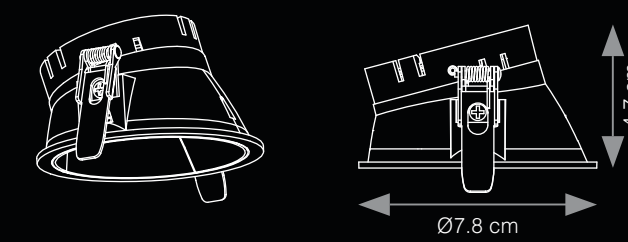

ITEM CODE	COLOR
T-HB46365WC	TRIM : WHITE REFLECTOR : CHROME
T-HB46365WG	TRIM : WHITE REFLECTOR : GOLD
T-HB46365WS	TRIM : WHITE REFLECTOR : SILVER
T-HB46365W	TRIM : WHITE REFLECTOR : WHITE
T-HB46365B	TRIM : BLACK REFLECTOR : BLACK
T-HB46365BG	TRIM : BLACK REFLECTOR : GOLD
T-HB46365WB	TRIM : WHITE REFLECTOR : BLACK

WALL WASHER

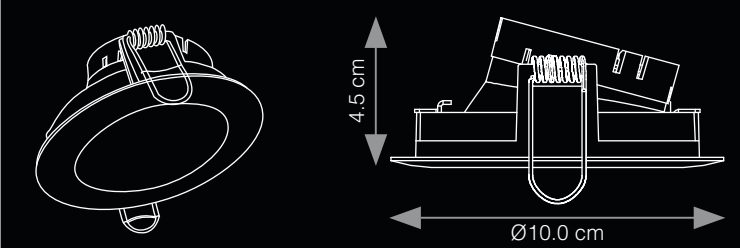





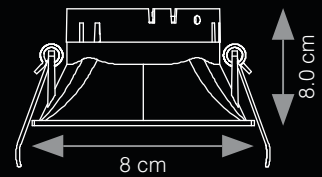
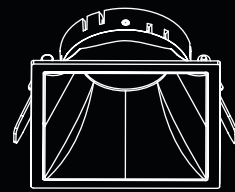

ITEM CODE	COLOR
T-HB46365WC	TRIM : WHITE REFLECTOR : CHROME
T-HB46365WG	TRIM : WHITE REFLECTOR : GOLD
T-HB46365WS	TRIM : WHITE REFLECTOR : SILVER
T-HB46365W	TRIM : WHITE REFLECTOR : WHITE
T-HB46365B	TRIM : BLACK REFLECTOR : BLACK
T-HB46365BG	TRIM : BLACK REFLECTOR : GOLD

IVEX COB RINGS

RECESSED SQUARE



ITEM CODE	COLOR
 T-HB46367WC	TRIM: WHITE REFLECTOR: CHROME
 T-HB46367WG	TRIM: WHITE REFLECTOR: GOLD
 T-HB46367WS	TRIM: WHITE REFLECTOR: SILVER
 T-HB46367W	TRIM: WHITE REFLECTOR: WHITE
 T-HB46367B	TRIM: BLACK REFLECTOR: BLACK
 T-HB46367BG	TRIM: BLACK REFLECTOR: GOLD

TRIM LESS

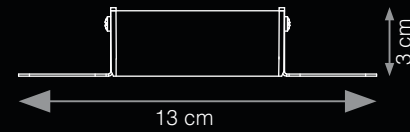
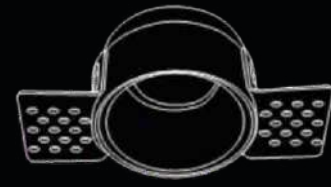

ITEM CODE	COLOR
 ER112WRC	WHITE - RED COPPER
 ER119WBC	WHITE - BLACK
 ER092BRC	BLACK - RED COPPER
 ER111WJW	WHITE - WHITE

IVEX PRO COB RINGS

DESCRIPTION

Ivex Pro Rings are a combination of Trim and reflector with a variety of Designs

Flexibility of use with different wattage LED modules as per requirement.

Wide range of colour options of *Trim* and *Reflector* to choose from, to match your interiors

Trimless version available for a cleaner and smoother look

MATERIAL OF CONSTRUCTION

Die cast aluminium body with SS mounting clips for ease of mounting & durability

APPLICATION AREA

Residences | hotels | Conference halls | Showrooms

COB RINGS

DIE CAST ALUMINIUM

APPLICATION SPECIFIC DESIGNS

MULTIPLE COLOUR COMBINATIONS

SUITABLE FOR IVEX MODULES

TRIMLESS VERSION AVAILABLE

RECESSED ROUND

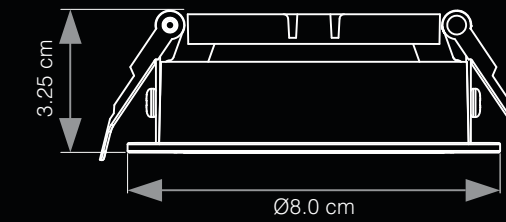

ITEM CODE	COLOR
 IPAR0092	WHITE
 IPAR0093	WHITE - BLACK
 IPAR0083	WHITE
 IPAR0095	WHITE - BLACK
 IPAR0085	WHITE - BLACK

TRIMLESS ROUND

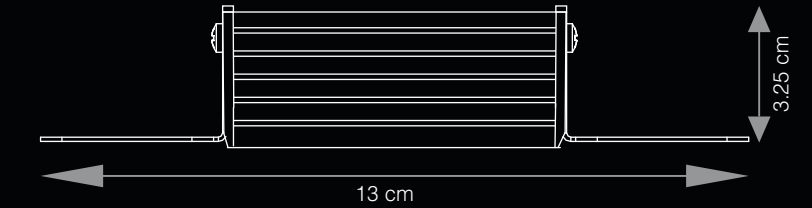

ITEM CODE	COLOR
 IPAR0102	FRAME : WHITE REFLECTOR : CHROME GOLD
 IPAR0103	FRAME : WHITE REFLECTOR : WHITE
 IPAR0104	FRAME : WHITE REFLECTOR : MATT GOLD
 IPAR0105	FRAME : WHITE REFLECTOR : BLACK CHROME
 IPAR0107	FRAME : BLACK REFLECTOR : CHROME

GIMBAL RINGS RECESSED SQUARE

- DIE CAST ALUMINIUM
- APPLICATION SPECIFIC DESIGNS
- MULTIPLE COLOUR COMBINATIONS
- SUITABLE FOR IVEK & EAGLE MODULES
- TRIMLESS VERSION AVAILABLE

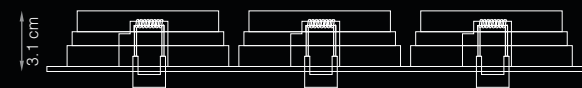
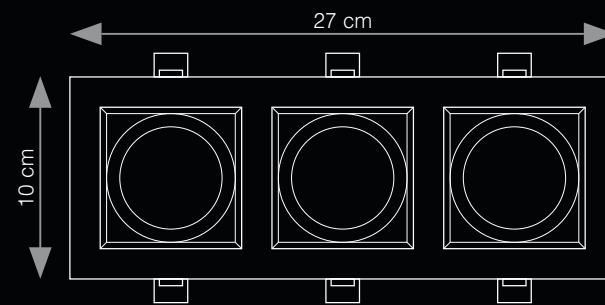
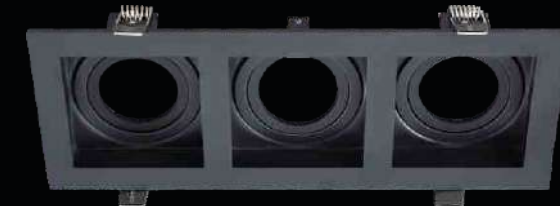
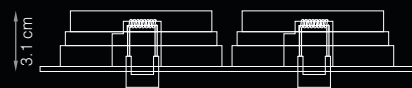
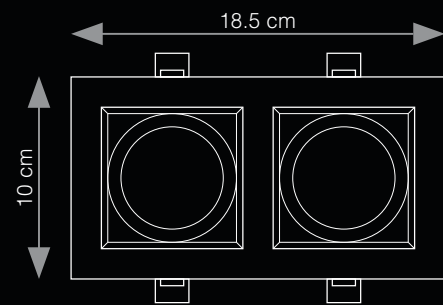
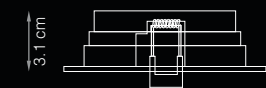
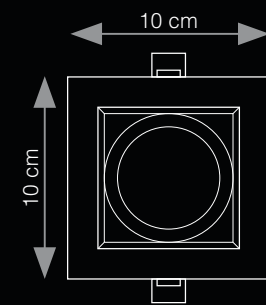

ITEM CODE GART241

COLOR BLACK

GART242

BLACK

GART243

BLACK

GIMBAL & EAGLE COB RINGS

DESCRIPTION

EAGLE COB RINGS

A combination of Trim and reflector with variety of Designs

Flexibility of use with different wattage LED modules as per requirement

Wide range of colour options of *Trim* and *Reflector* to choose from, to match your interiors

Suitable for Eagle COB LED Module

GIMBAL RINGS

Die Cast Aluminium Frame / Housing with SS Mounting Clips

Especially suitable for Retail, Museum application to highlight objects/artefacts

Tiltable to enable accentuating as per the requirement

Can be used with Ivex and Eagle modules.

Available in 1M, 2M and 3M configuration

MATERIAL OF CONSTRUCTION

Die cast aluminium body with SS mounting clips for ease of mounting & durability

APPLICATION AREA

Residences | hotels | Conference halls | Showrooms

EAGLE COB RINGS RECESSED ROUND

COB RINGS

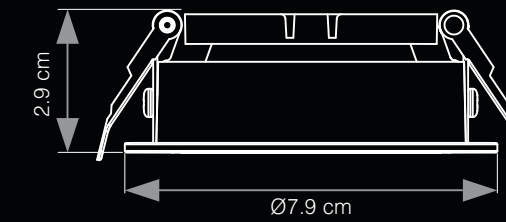

	ITEM CODE	COLOR
	EA7929WRC	TRIM: WHITE REFLECTOR: RED COPPER
	EA7929BB	TRIM: BLACK REFLECTOR: BLACK
	EA7929WB	TRIM: WHITE REFLECTOR: BLACK
	EA7929WS	TRIM: WHITE REFLECTOR: SILVER
	EA7929BRC	TRIM: BLACK REFLECTOR: RED COPPER
	EA7929WW	TRIM: WHITE REFLECTOR: WHITE
	EA7929WBC	TRIM: WHITE REFLECTOR: BLACK CHROME
	EA7929BBC	TRIM: BLACK REFLECTOR: BLACK CHROME

EAGLE MODULE

- DIE CAST ALUMINIUM
- OPTIMUM HEAT SINK DESIGN
- MULTIPLE OUTER RING OPTIONS
- MODULAR DESIGN

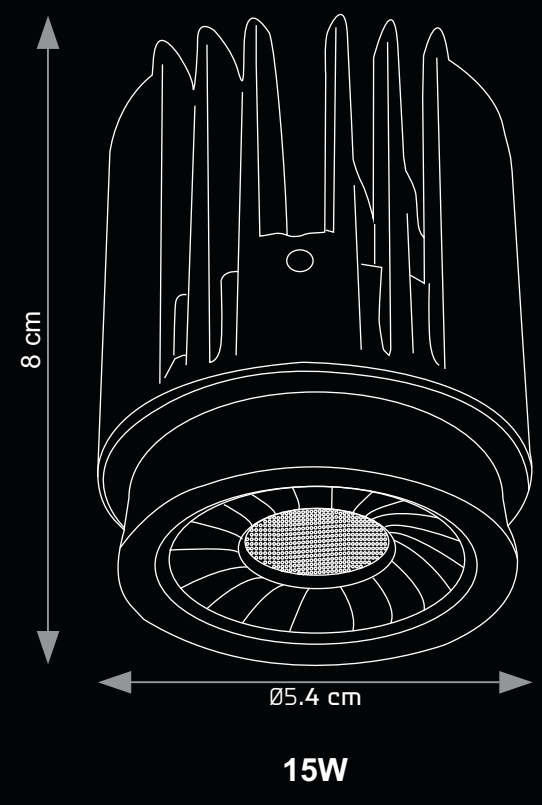
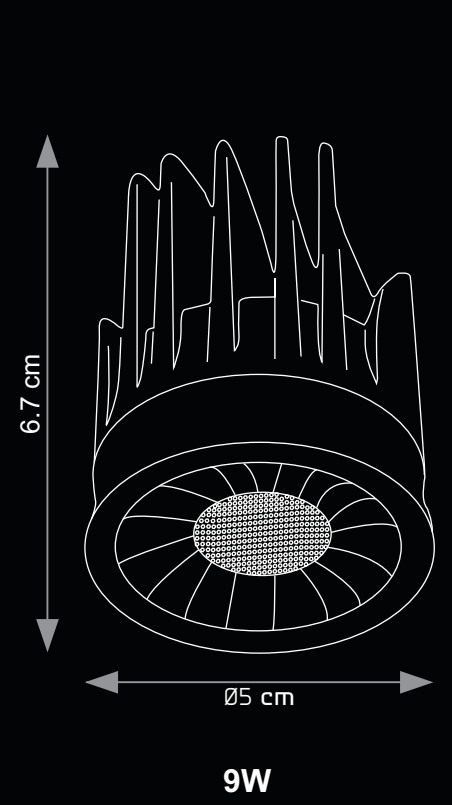

EAGLE LED MODULE

DESCRIPTION

Recessed LED Module: To be used along With Ivex / Eagle rings

Modular design, option for Fixed, tiltable and trim or Trimless application

Compact, aesthetic and sleek design

Easy to mount on P.O.P Ceilings

MATERIAL OF CONSTRUCTION

Die Cast aluminum housing.

TECHNICAL INFORMATION

- Wattage:** 9W & 15W
- CRI:** ≥80, For Better Light Quality
- SDCM:** ≤5, ensures better colour consistency
- Input Voltage:** 220 V AC - 240 V AC
- Surge Protection:** ≤2.5KV
- IP Rating:** IP 20,
- Life:** ≥30,000 burning hours
- Dimmability:** On Request. Please get in touch with Tisva Team for Dimming Options

APPLICATION AREA

Residences | Hotels |
Modern Work Spaces | Showrooms

LED MODULE

LUMINOUS INTENSITY DISTRIBUTION CURVE

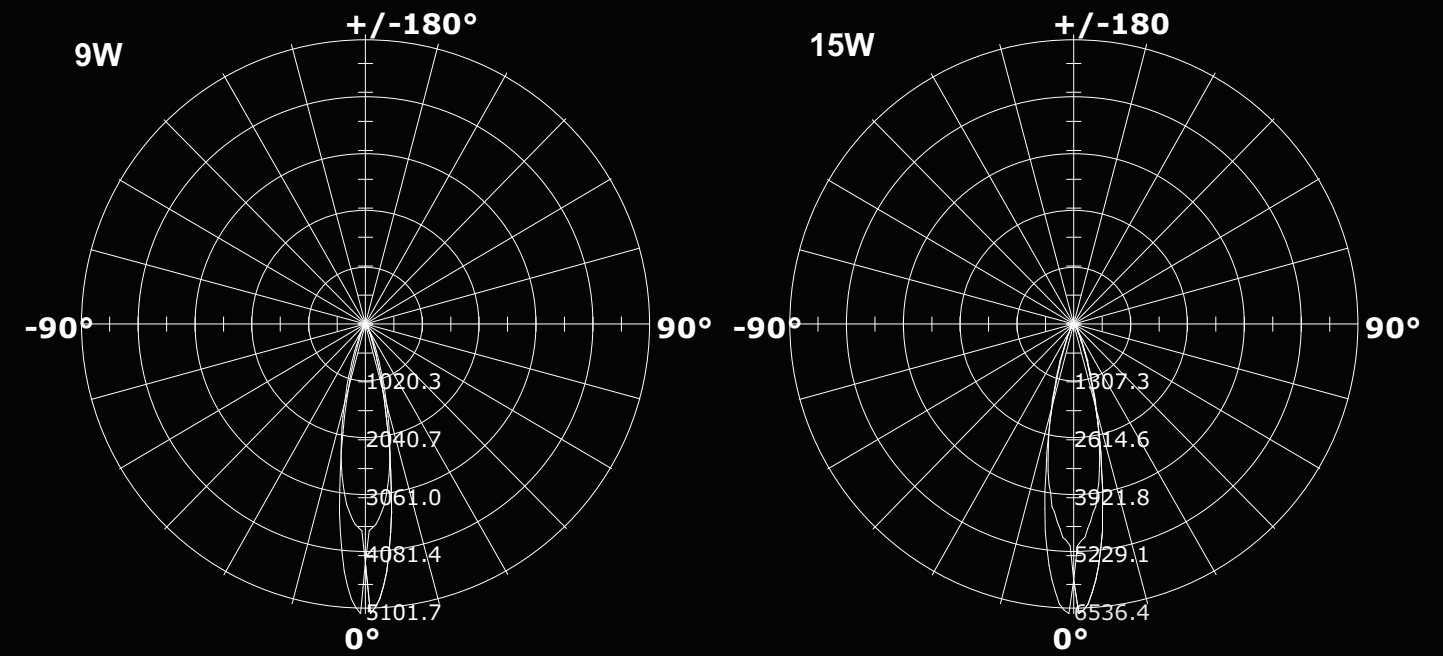

AVERAGE ILLUMINANCE AT A DISTANCE

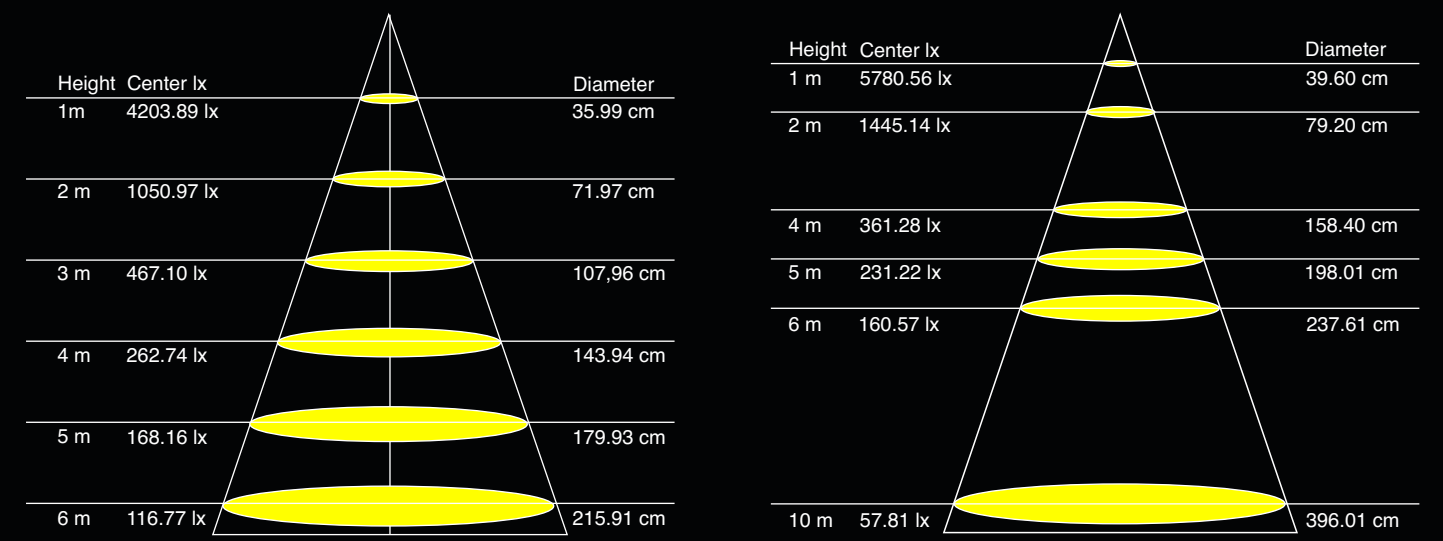

ITEM CODE	WATTAGE	CCT	DIMENSIONS (in cms)	LUMENS	INPUT VOLTAGE (AC)	BEAM ANGLE
DL09112116	9W	3000K	A - Ø5.0 C - 6.7	900	220 U AC- 240 U AC	40°
DL09312116	9W	4000K	A - Ø5.0 C - 6.7	940	220 U AC- 240 U AC	40°
DL09612116	9W	6500K	A - Ø5.0 C - 6.7	980	220 U AC- 240 U AC	40°
DL15112116	15W	3000K	A - Ø5.4 C - 8.0	1500	220 U AC- 240 U AC	40°
DL15312116	15W	4000K	A - Ø5.4 C - 8.0	1570	220 U AC- 240 U AC	40°
DL15612116	15W	6500K	A - Ø5.4 C - 8.0	1620	220 U AC- 240 U AC	40°

Dimensions: A- LHW/Diameter | C- Height

EAGLE PRO

- DIE CAST ALUMINIUM
- OPTIMUM HEAT SINK DESIGN
- MULTIPLE OUTER RING OPTIONS
- MODULAR DESIGN

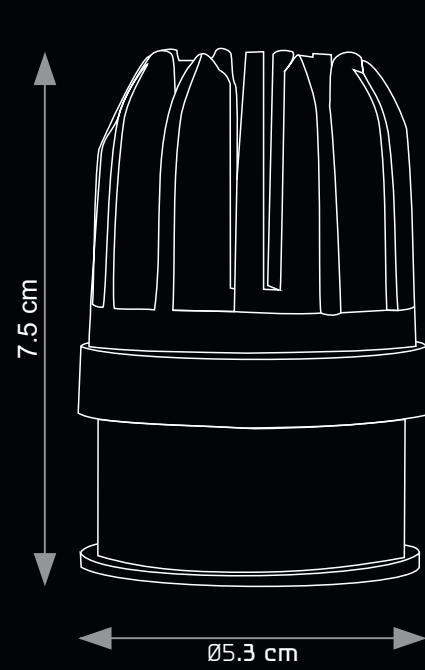

9W

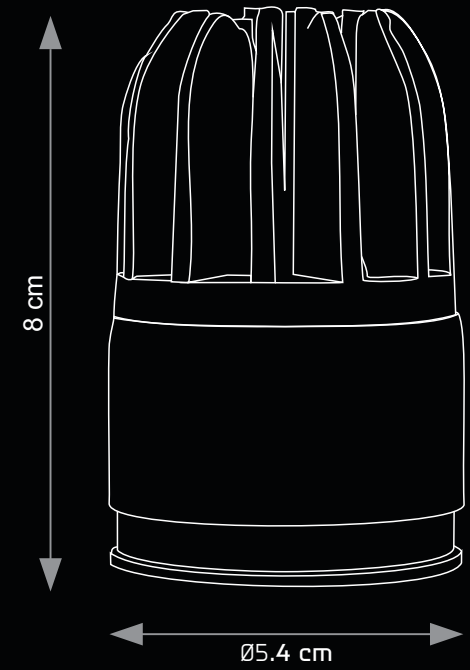

15W

EAGLE PRO

DESCRIPTION

Recessed downlighter LED module, To be used with ivex / eagle rings

Modular design, option for Fixed, tiltable and variety of Colour combination of trim and Trimless application

Compact, aesthetic and sleek design

Easy to mount on p.o.p Ceilings

MATERIAL OF CONSTRUCTION

Die Cast aluminum housing.

TECHNICAL INFORMATION

- Wattage:** 9W & 15W
- CRI:** ≥80, For Better Light Quality
- SDCM:** ≤3, ensures better colour consistency
- Input Voltage:** 220 V AC - 240 V AC
- Surge Protection:** ≤2.5KV
- IP Rating:** IP 20,
- Life:** ≥30,000 burning hours
- Dimmability:** On Request. Please get in touch with Tisva Team for Dimming Options

APPLICATION AREA

Residences | Hotels | Modern Work Spaces | Showrooms

LED MODULE

LUMINOUS INTENSITY DISTRIBUTION CURVE

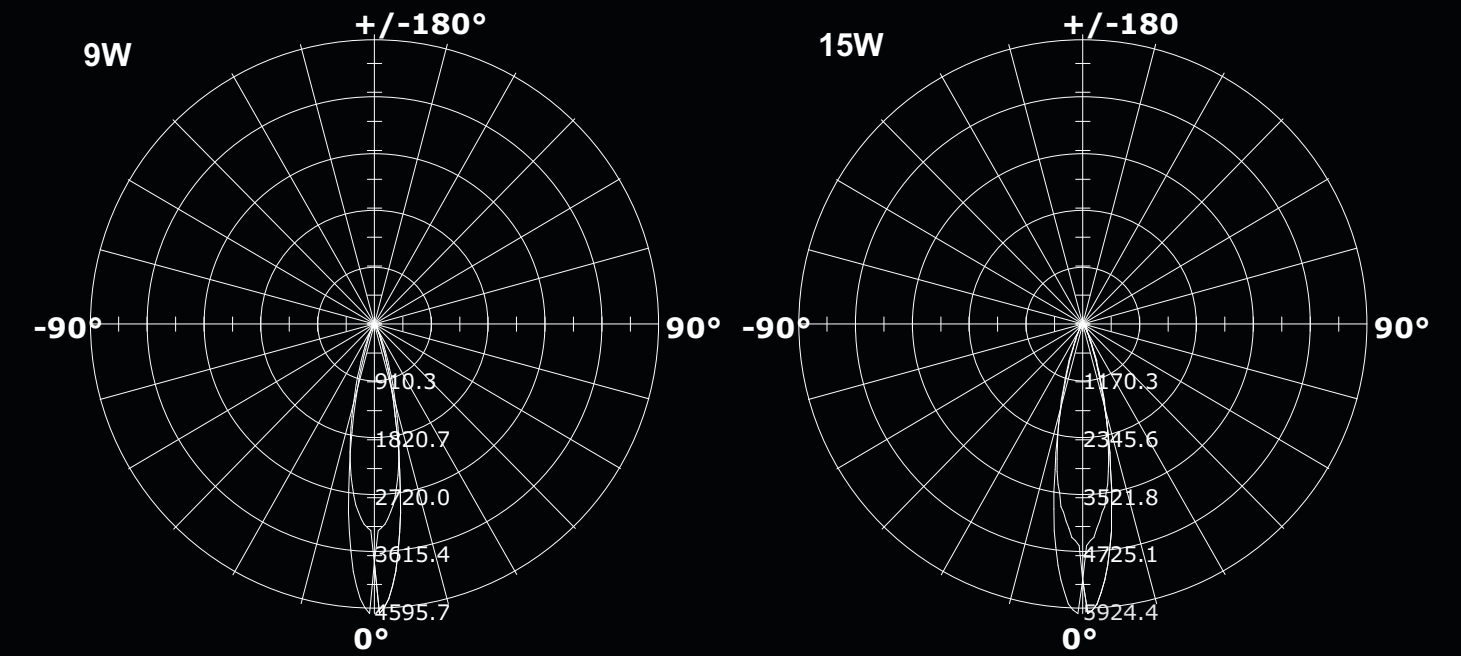

AVERAGE ILLUMINANCE AT A DISTANCE

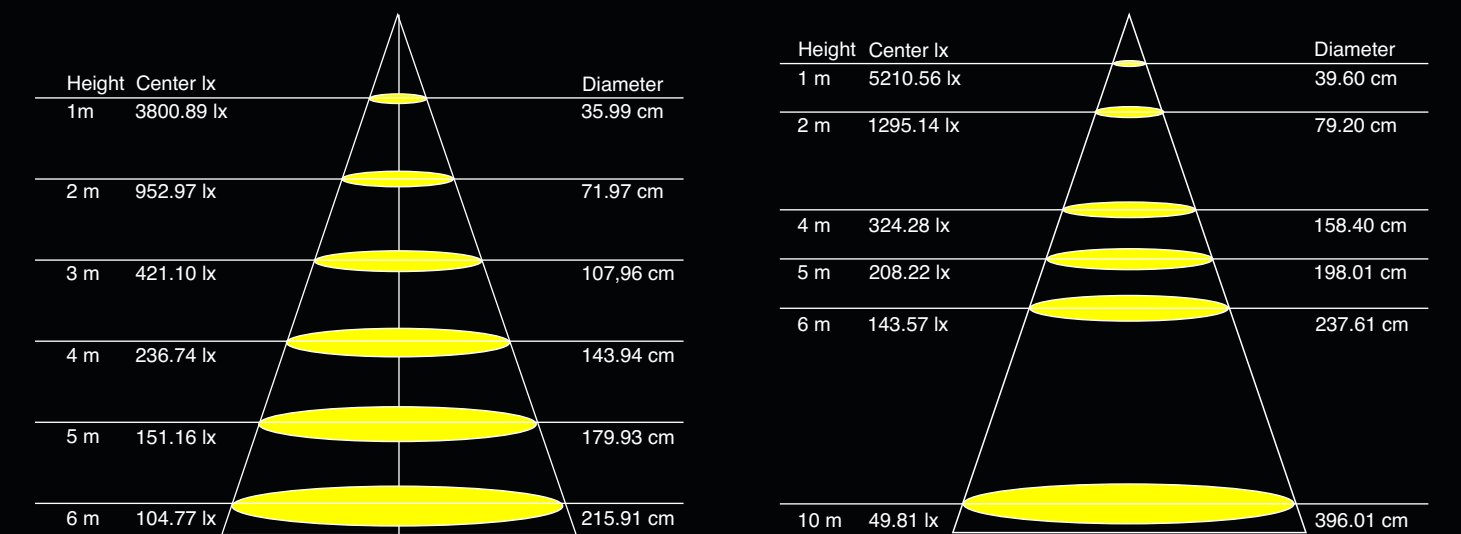

ITEM CODE	WATTAGE	CCT	DIMENSIONS (in cms)	LUMENS	INPUT VOLTAGE (AC)	BEAM ANGLE
DL9W38D3KN	9W	3000K	A - Ø5.3 C - 7.5	800 lm	220 U AC- 240 U AC	38°
DL9W38D4KN	9W	4000K	A - Ø5.3 C - 7.5	840 lm	220 U AC- 240 U AC	38°
DL15W383KN	15W	3000K	A - Ø5.3 C - 7.5	1350 lm	220 U AC- 240 U AC	38°
DL15W384KN	15W	4000K	A - Ø5.3 C - 7.5	1410 lm	220 U AC- 240 U AC	38°



TRACK LIGHTING SYSTEM

CALANTEPROSYSTEM | AXIOSYSTEM

CALANTE PRO LINEAR-FROSTED

- MAGNETIC TRACK MOUNTED
- DIE CAST / EXTRUDED ALUMINIUM
- SNAP FIT
- UBER MODERN & SLEEK DESIGN
-



LUMINOUS INTENSITY DISTRIBUTION CURVE

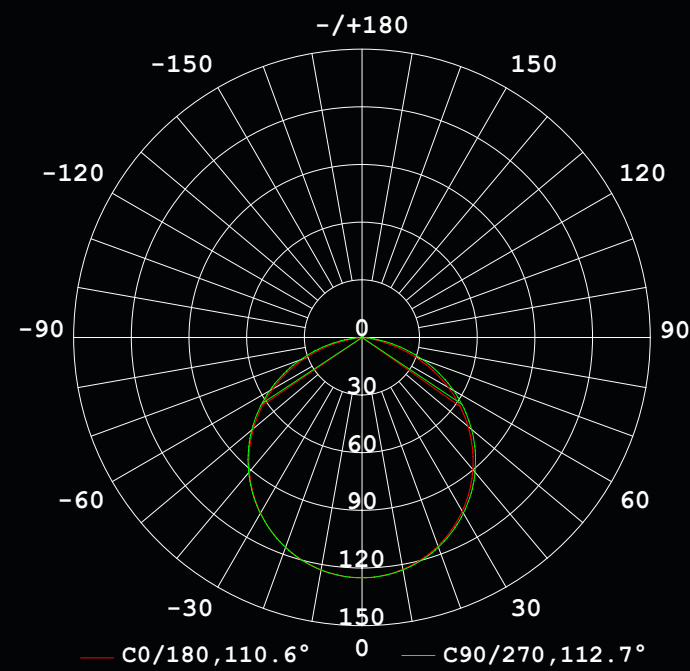

AVERAGE ILLUMINANCE AT A DISTANCE

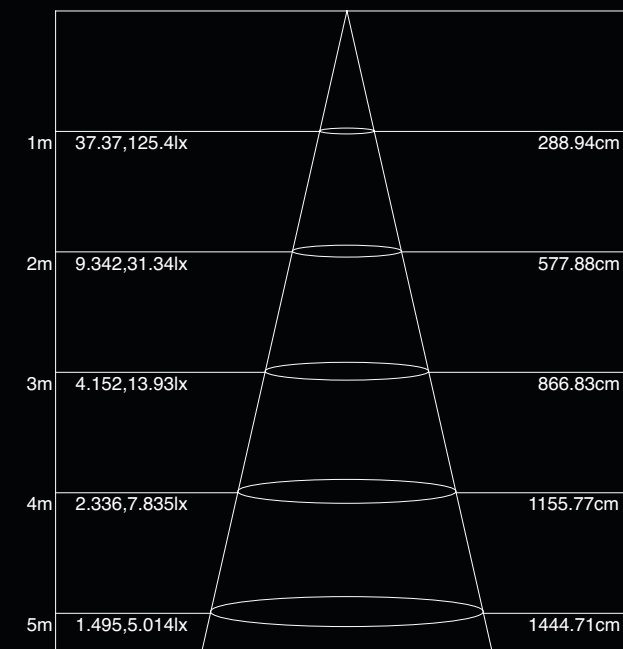

ITEM CODE	WATTAGE	CCT	DIMENSIONS (in cms)	LUMENS	CRI	IP RATING	INPUT VOLTAGE	BEAM ANGLE
TKL1029	10W	3000K	L - 32 W - 3.4 H - 5.6	400	≥80	20	24 V DC	110°
TKL1039	10W	4000K	L - 32 W - 3.4 H - 5.6	445	≥80	20	24 V DC	110°

Dimensions: L - Length | W - Width | H - Height

CALANTE PRO

DESCRIPTION

Magnetic Track System. Ideal to create that sleek and contemporary look.

Linear fixtures with options of frosted linear and Linear COB to match your taste and application.

Achieve the desired uber modern interiors with combination of fixtures from the *Calante Pro*.

MATERIAL OF CONSTRUCTION

Powder Coated Mild Steel

TECHNICAL INFORMATION

Wattage:
Linear Frosted-10W
Linear COB- 6W

CRI: ≥80, For Better Light Quality

SDCM: ≤4, ensures better colour consistency

Input Voltage: 24 V DC

Surge Protection: ≤2.5KV

IP Rating: IP 20,

Life: ≥30,000 burning hours

Dimmability: On Request. Please get in touch with Tisva Team for Dimming Options

APPLICATION AREA

Residences | Art Galleries | Retail | Museums | Modern Offices

LINEAR-COB

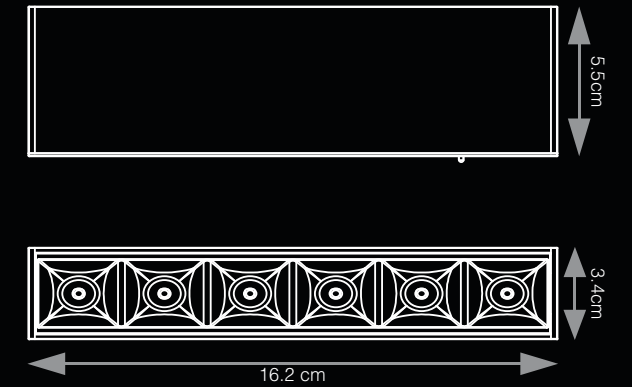

LUMINOUS INTENSITY DISTRIBUTION CURVE

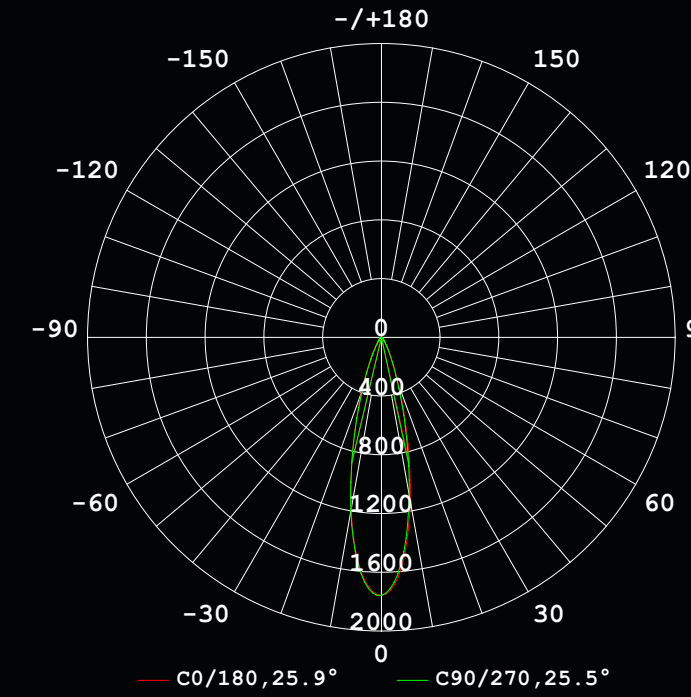

AVERAGE ILLUMINANCE AT A DISTANCE

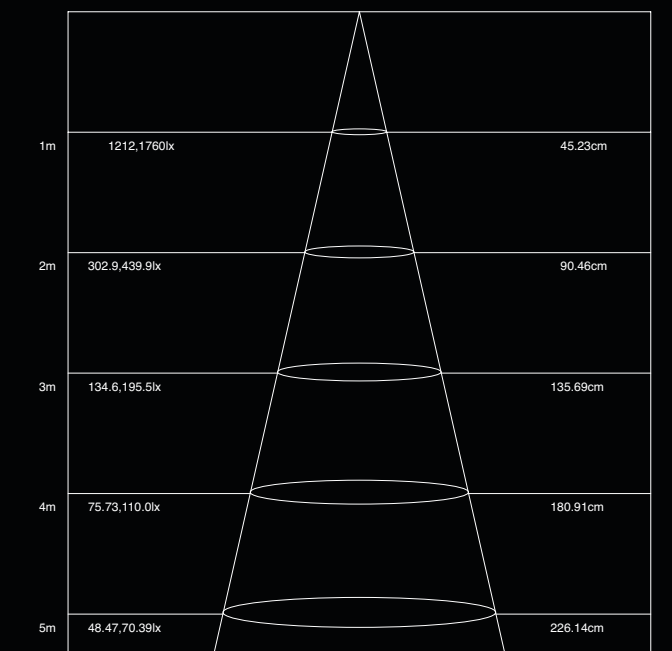

ITEM CODE	WATTAGE	CCT	DIMENSIONS (in cms)	LUMENS	CRI	IP RATING	INPUT VOLTAGE	BEAM ANGLE
TKL6291	6W	3000K	L - 16.2 W - 3.4 H - 5.6	420	≥80	20	24 V DC	25°
TKL6391	6W	4000K	L - 16.2 W - 3.4 H - 5.6	450	≥80	20	24 V DC	25°

Dimensions: L - Length | W - Width | H - Height

CALANTE PRO SPOTLIGHT



- MAGNETIC
TRACK
MOUNTED
- SNAP FIT
- UBER MODERN
&
SLEEK DESIGN
-

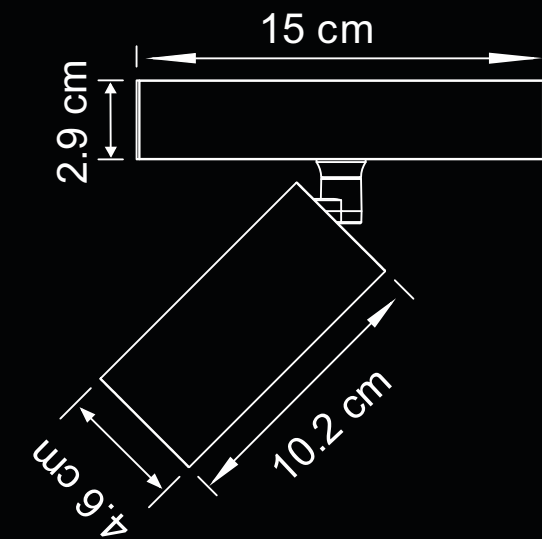

LUMINOUS INTENSITY DISTRIBUTION CURVE

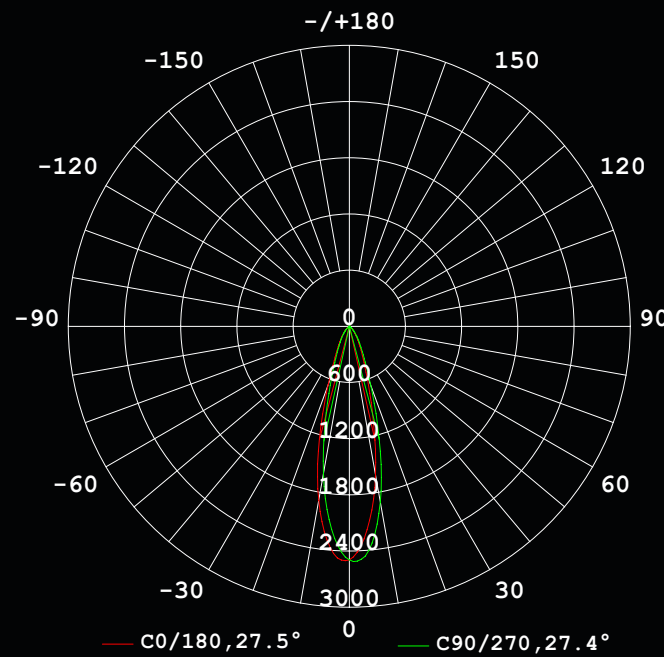

AVERAGE ILLUMINANCE AT A DISTANCE

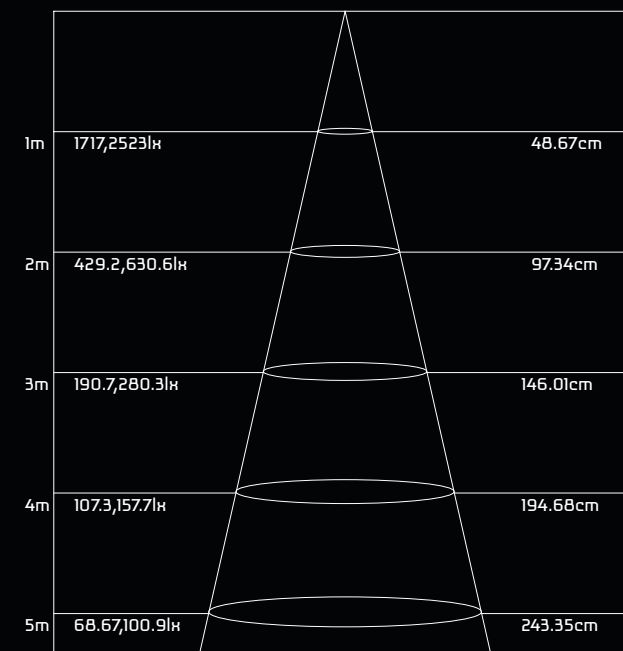

ITEM CODE	WATTAGE	CCT	DIMENSIONS (in cms)	LUMENS	CRI	IP RATING	INPUT VOLTAGE	BEAM ANGLE
TKL10293	10W	3000K	D - 4.6 W - 14.8	700	≥80	20	24 V DC	25°
TKL10393	10W	4000K	D - 4.6 W - 14.8	700	≥80	20	24 V DC	25°

Dimensions: D- Diameter | W - Width

CALANTE PRO

DESCRIPTION

Magnetic Track System. Ideal to create that sleek and contemporary look.

Track Mountable Spot Light with unique snap fit design. Swivel design ensures flexibility in directing light to the desired surfaces/objects.

Pendant : Track mountable. Sleek design for the contemporary look.

MATERIAL OF CONSTRUCTION

Powder Coated Mild Steel

TECHNICAL INFORMATION

Wattage:
Linear Frosted-10W
Linear COB- 6W

CRI: ≥80, For Better Light Quality

SDCM: ≤4, ensures better colour consistency

Input Voltage: 24 V DC

Surge Protection: ≤2.5KV

IP Rating: IP 20,

Life: ≥30,000 burning hours

Dimmability: On Request. Please get in touch with Tisva Team for Dimming Options

APPLICATION AREA

Residences | Art Galleries | Retail | Museums | Modern Offices

PENDANT

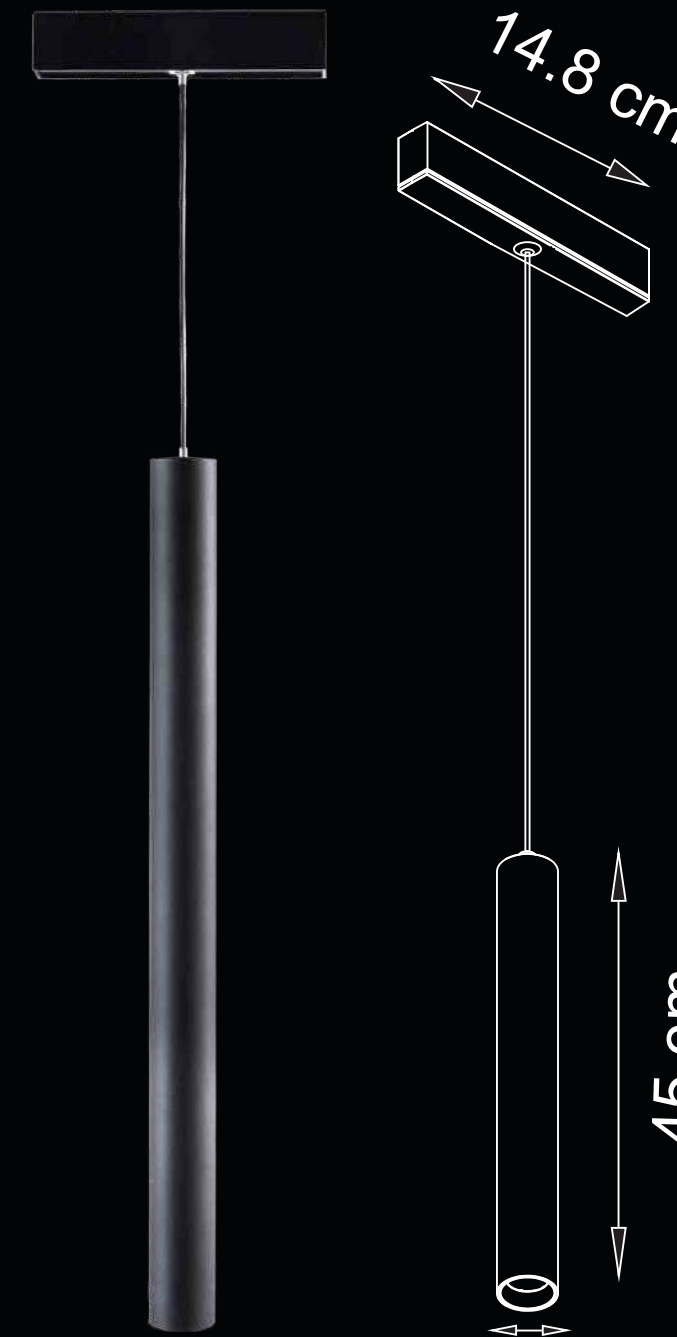

MAGNETIC TRACKLIGHTS

LUMINOUS INTENSITY DISTRIBUTION CURVE

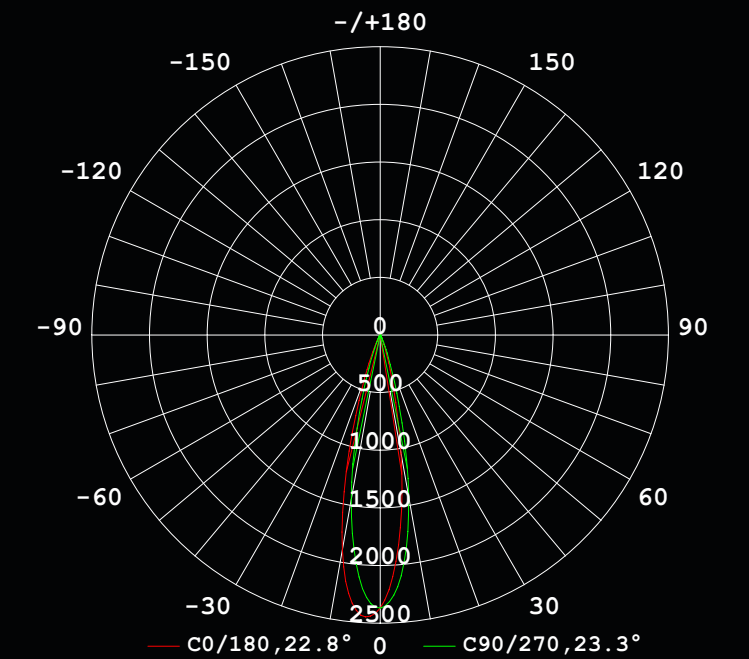

AVERAGE ILLUMINANCE AT A DISTANCE

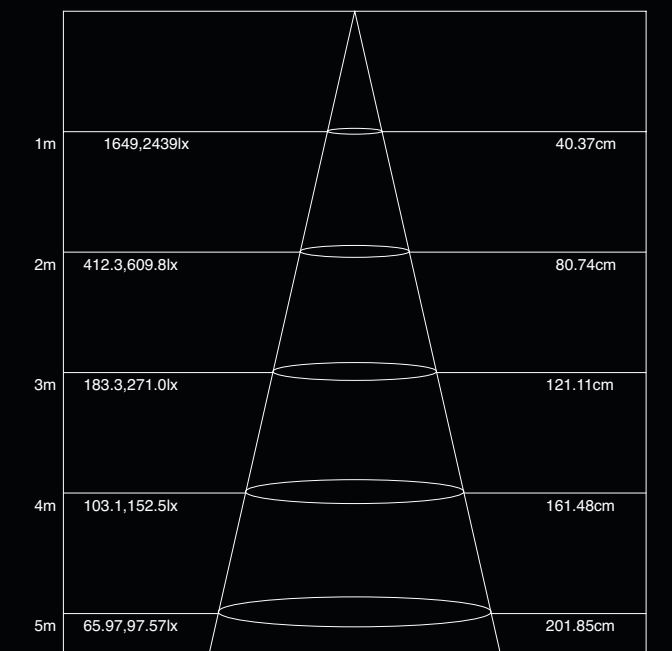

ITEM CODE	WATTAGE	CCT	DIMENSIONS (in cms)	LUMENS	CRI	IP RATING	INPUT VOLTAGE	BEAM ANGLE
TKL6295	6W	3000K	D - 3.5 W - 14.8	400	≥80	20	24 V DC	25°
TKL6395	6W	4000K	D - 3.5 W - 14.8	400	≥80	20	24 V DC	25°

Dimensions: D- Diameter | W - Width

CALANTE PRO

COB LINEAR TILTABLE



- MAGNETIC TRACK MOUNTED
- SNAP FIT
- UBER MODERN & SLEEK DESIGN

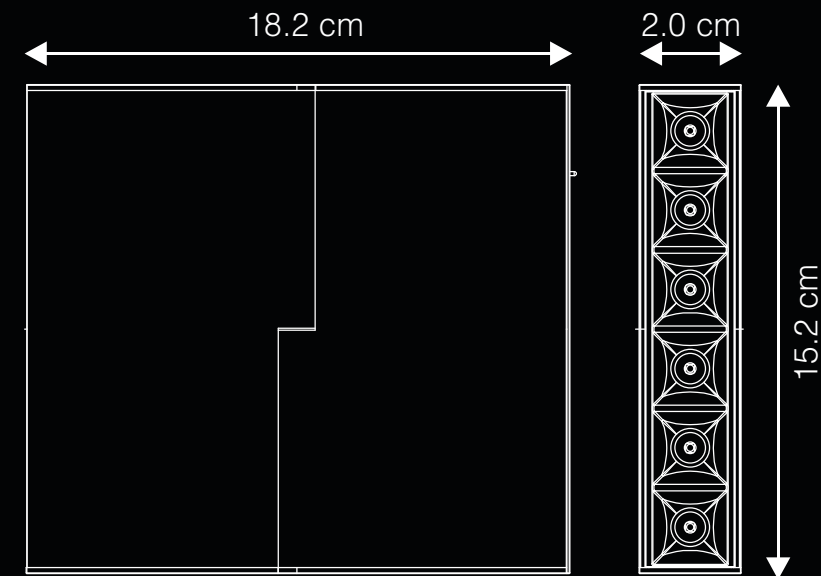

LUMINOUS INTENSITY DISTRIBUTION CURVE

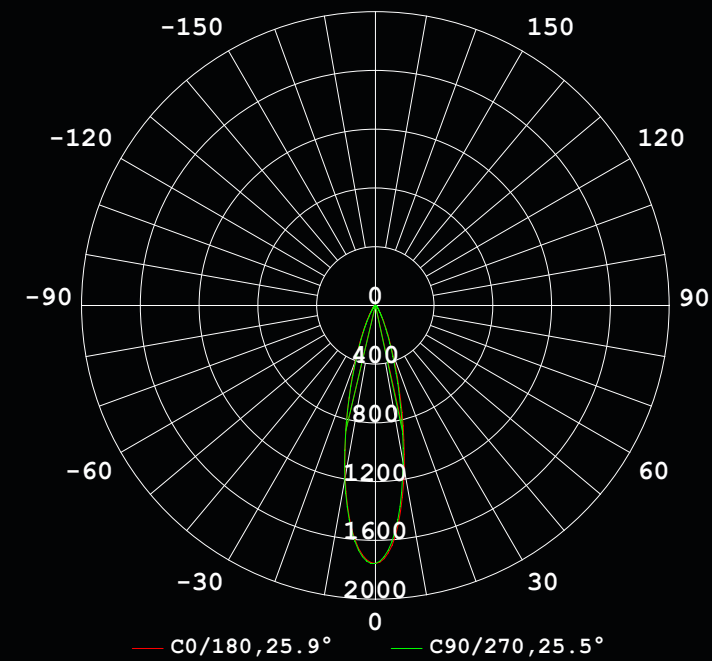

Wattage: 6W
 CRI: ≥90,
 SDCM: ≤5,
 Input Voltage: 24V DC
 Surge Protection: ≤2.5kV
 IP Rating: IP 20
 Dimmability: On Request
 Life: ≥30,000

AVERAGE ILLUMINANCE AT A DISTANCE

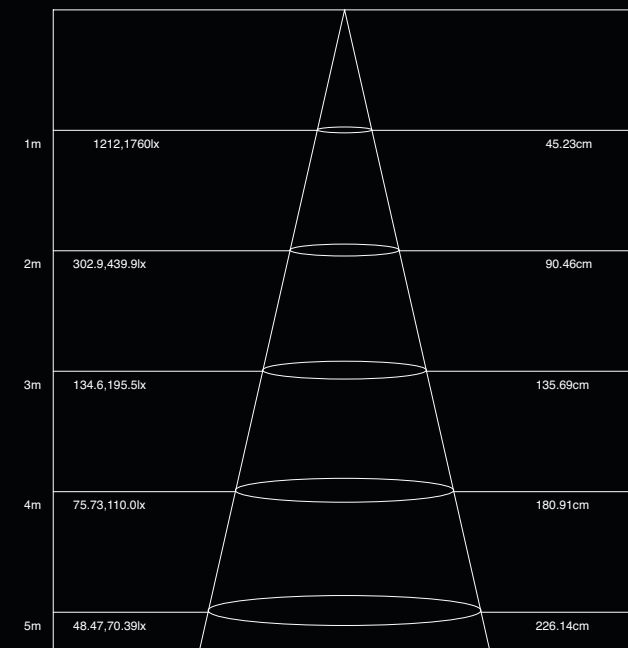

ITEM CODE	WATTAGE	CCT	DIMENSIONS (in cms)	LUMENS	CRI	IP RATING	INPUT VOLTAGE	BEAM ANGLE
TAG29AD	6W	3000K	L - 15.2 cm W - 2 cm H - 18.2 cm	450 LM	≥80	20	24 V DC	25°

Dimensions: D- Diameter | W - Width

CALANTE PRO

DESCRIPTION

Magnetic Track System. Ideal to create that sleek and contemporary look.

Linear fixtures with options of frosted linear and Linear COB to match your taste and application.

Achieve the desired uber modern interiors with combination of fixtures from the Calante Pro.

MATERIAL OF CONSTRUCTION

Powder Coated Mild Steel

TECHNICAL INFORMATION

Wattage: Linear Frosted- 10W
 Linear COB- 6W

CRI: ≥80, For Better Light Quality

SDCM: ≤4, ensures better colour consistency

Input Voltage: 24 V DC

Surge Protection: ≤2.5KV

IP Rating: IP 20,

Life: ≥30,000 burning hours

Dimmability: On Request. Please get in touch with Tisva Team for Dimming Options

APPLICATION AREA

Residences | Art Galleries | Retail | Museums | Modern Offices

FROSTED LINEAR TILTABLE



MAGNETIC TRACK LIGHTS

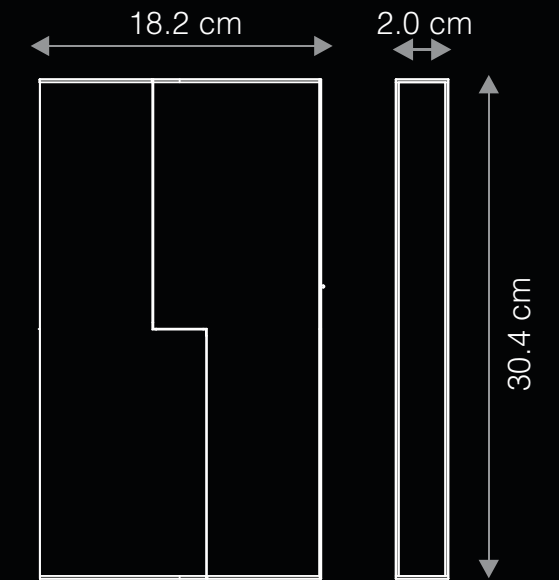

LUMINOUS INTENSITY DISTRIBUTION CURVE

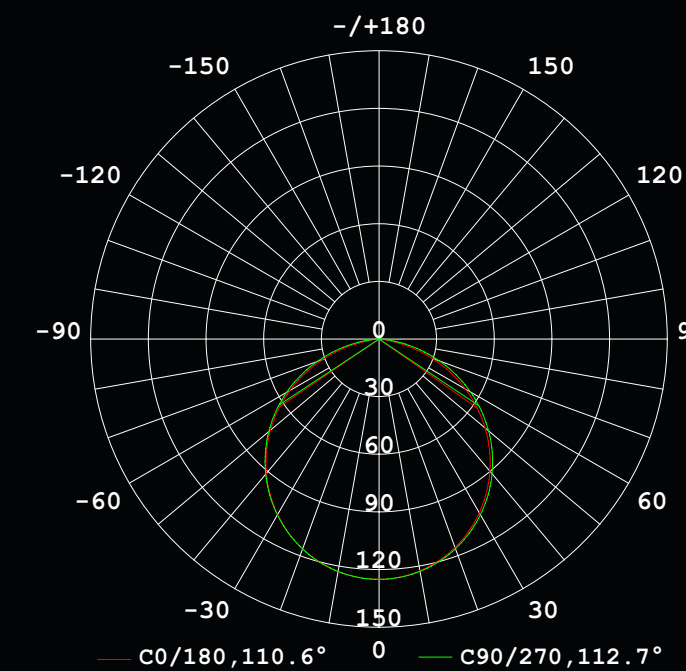

AVERAGE ILLUMINANCE AT A DISTANCE

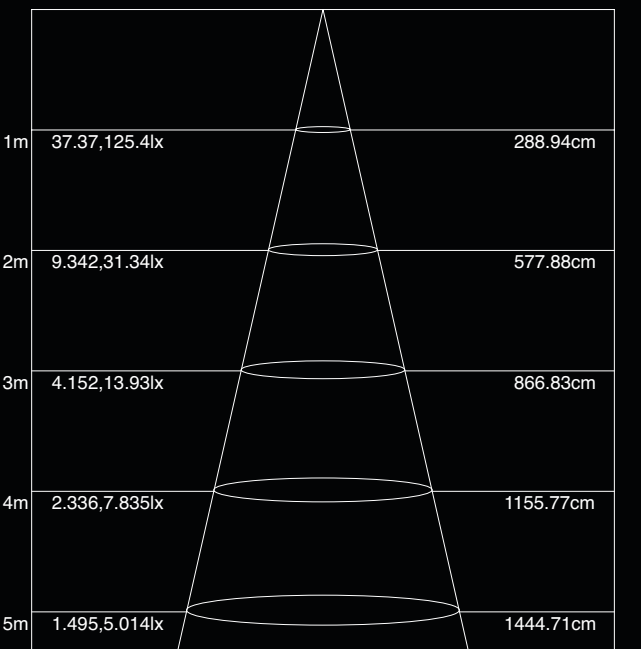

ITEM CODE	WATTAGE	CCT	DIMENSIONS (in cms)	LUMENS	CRI	IP RATING	INPUT VOLTAGE	BEAM ANGLE
TA10W3K	10W	3000K	L - 32.3 cm W - 2 cm H - 18.1 cm	360	≥80	20	24VDC	25°

Dimensions: D- Diameter | W - Width

CALANTE PRO ACCESORIES



L CONNECTOR INNER
ITEM CODE : MGLCI2519

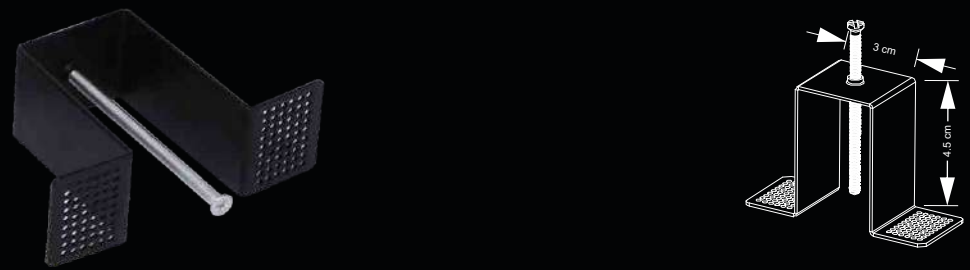

RECESS ACCESSORY
ITEM CODE : MGRA25149

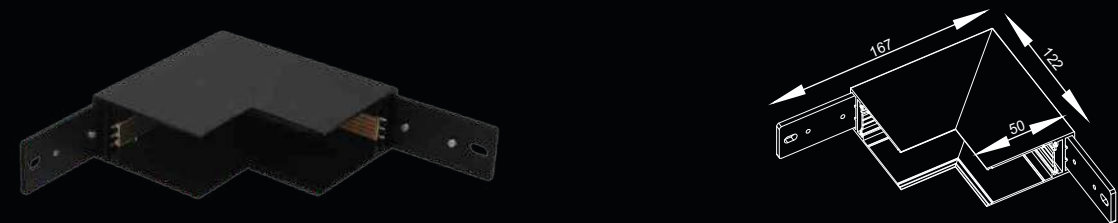

L CONNECTOR OUTER
ITEM CODE : MGLCO2519

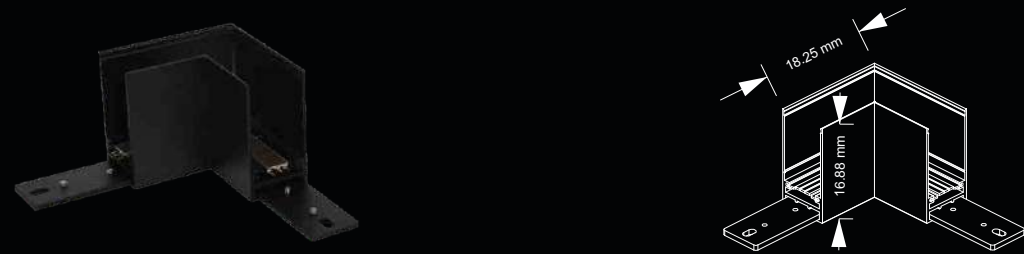

L CONNECTOR 90 VERTICAL
ITEM CODE : MGLCV2519

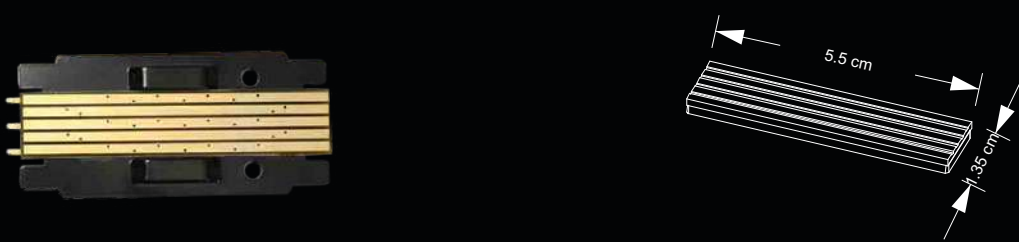

TRACK POWER CONDUCTOR
ITEM CODE : MG25149C

CALANTE PRO ACCESORIES

MAGNETIC TRACKLIGHTS

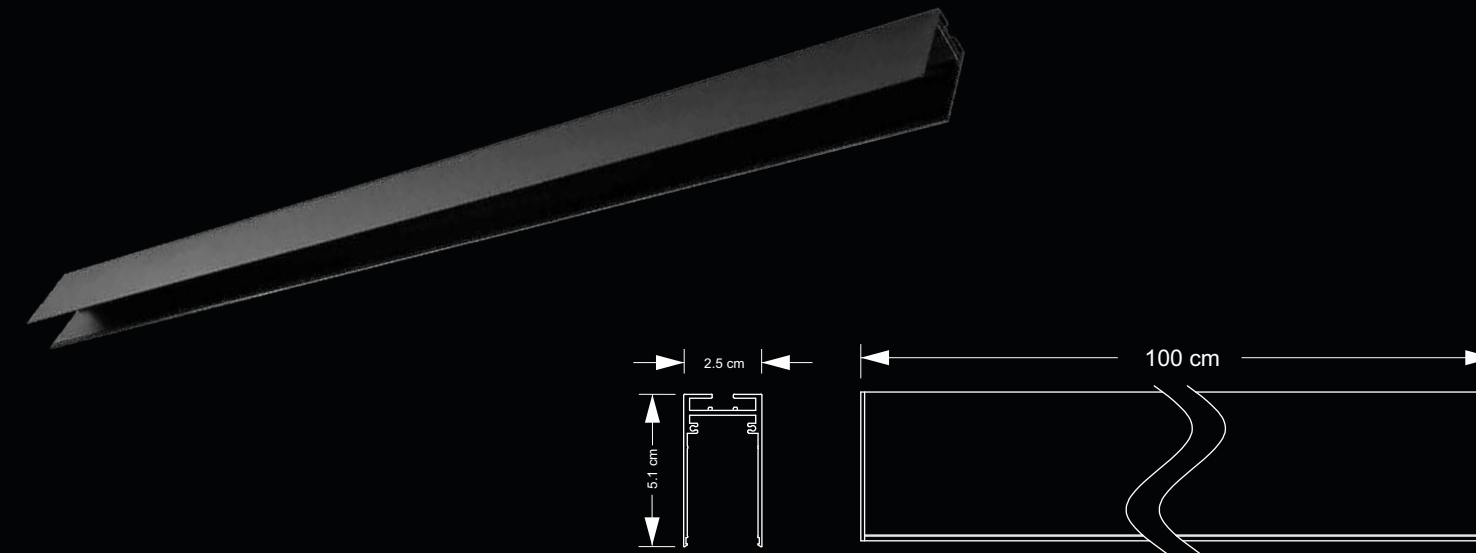

MAGNETIC TRACK
ITEM CODE : MG25149
DIMENSION : L 100 cm X W 2.5 cm X H 5.1 cm

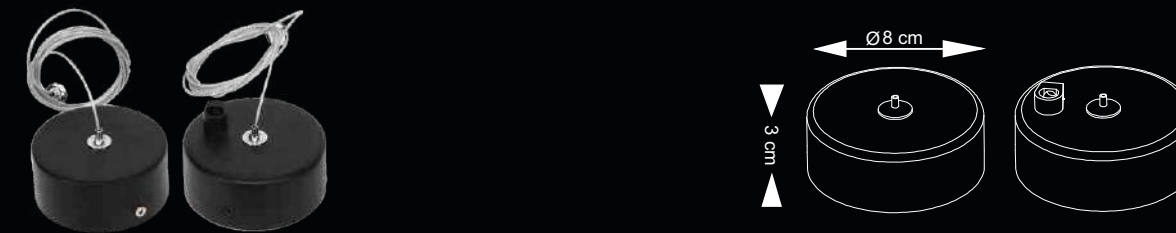

PENDANT ACCESSORY
ITEM CODE : MGSP25149

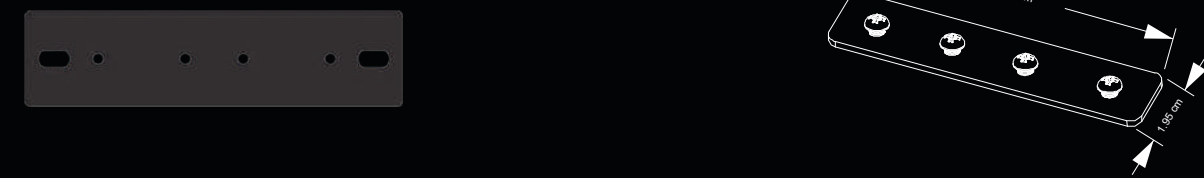

TRACK CONNECTOR
ITEM CODE : MGCN25149

MOUNTING BOX

MOUNTING BOX
ITEM CODE : MGPTB2519

LED DRIVER

LED DRIVER
ITEM CODE : APT10024

AXIOS TRACK LIGHT

- METAL CORE PCB FOR BETTER HEAT DISSIPATION
- POWDER COATED ALUMINIUM
- SOFT LIGHT OUTPUT FOR EYE COMFORT
- MODERN & SLEEK DESIGN

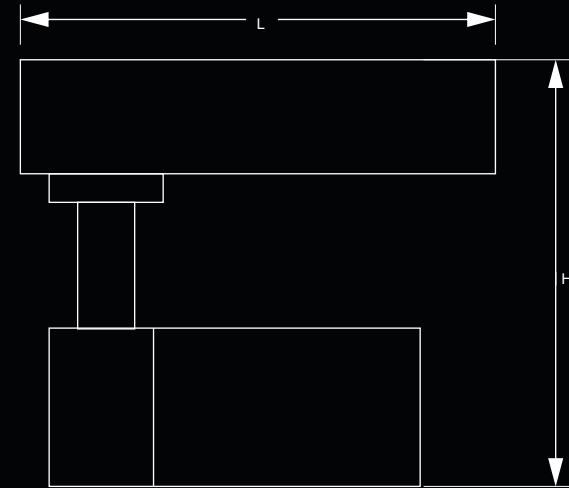
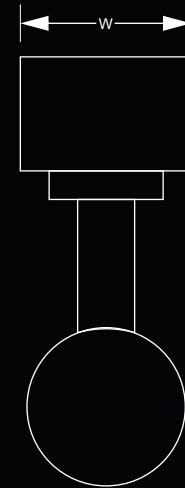

ITEM CODE	WATTAGE	BODY COLOUR	CCT	DIMENSIONS (in cms)	LUMENS	CRI	IP RATING	SURGE RATING (KV)	INPUT VOLTAGE (AC)	BEAM ANGLE
TKL1002	10W	WHITE	3000K	L- 12.5 W- 5.0 H- 17.2	640 LM	>80	20	2.5	220 V AC - 240 V AC	24°
TKL1003	10W	WHITE	4000K	L- 12.5 W- 5.0 H- 17.2	680 LM	>80	20	2.5	220 V AC - 240 V AC	24°
TKL1006	10W	WHITE	6500K	L- 12.5 W- 5.0 H- 17.2	800 LM	>80	20	2.5	220 V AC - 240 V AC	24°
TKL2002	20W	WHITE	3000K	L- 14.5 W- 6.0 H- 20.0	1280 LM	>80	20	2.5	220 V AC - 240 V AC	24°
TKL2003	20W	WHITE	4000K	L- 14.5 W- 6.0 H- 20.0	1380 LM	>80	20	2.5	220 V AC - 240 V AC	24°
TKL2006	20W	WHITE	6500K	L- 14.5 W- 6.0 H- 20.0	1600 LM	>80	20	2.5	220 V AC - 240 V AC	24°
TKL3002	30W	WHITE	3000K	L- 18.0 W- 8.0 H- 21.0	1920 LM	>80	20	2.5	220 V AC - 240 V AC	24°
TKL3003	30W	WHITE	4000K	L- 18.0 W- 8.0 H- 21.0	2070 LM	>80	20	2.5	220 V AC - 240 V AC	24°
TKL3006	30W	WHITE	6500K	L- 18.0 W- 8.0 H- 21.0	2400 LM	>80	20	2.5	220 V AC - 240 V AC	24°
TKL1092	10W	BLACK	3000K	L- 12.5 W- 5.0 H- 17.2	640 LM	>80	20	2.5	220 V AC - 240 V AC	24°
TKL1093	10W	BLACK	4000K	L- 12.5 W- 5.0 H- 17.2	680 LM	>80	20	2.5	220 V AC - 240 V AC	24°
TKL2092	20W	BLACK	3000K	L- 14.5 W- 6.0 H- 20.0	1280 LM	>80	20	2.5	220 V AC - 240 V AC	24°
TKL2093	20W	BLACK	4000K	L- 14.5 W- 6.0 H- 20.0	1380 LM	>80	20	2.5	220 V AC - 240 V AC	24°
TKL3092	30W	BLACK	3000K	L- 18.0 W- 8.0 H- 21.0	1920 LM	>80	20	2.5	220 V AC - 240 V AC	24°
TKL3093	30W	BLACK	4000K	L- 18.0 W- 8.0 H- 21.0	2070 LM	>80	20	2.5	220 V AC - 240 V AC	24°

Dimensions: L - Length | W - Width | H - Height

AXIOS TRACK LIGHT

AXIOS TRACK

TRACK SYSTEM

DESCRIPTION

Magnetic Track System. Ideal to create that sleek and contemporary look.

Track Mountable Spot Light with unique snap fit design. Swivel design ensures flexibility in directing light to the desired surfaces/objects.

MATERIAL OF CONSTRUCTION





Powder Coated Aluminium

TECHNICAL INFORMATION

- Wattage:** 10W, 20W & 30W
- CRI:** ≥70, For Better Light Quality
- SDCM:** ≤5, ensures better colour consistency
- Input Voltage:** 220 V AC - 240 V AC
- Surge Protection:** ≤2.5KV
- IP Rating:** IP 20,
- Life:** ≥30,000 burning hours
- Dimmability:** On Request. Please get in touch with Tisva Team for Dimming Options

APPLICATION AREA

Residences | Art Galleries | Retail | Museums | Modern Offices

	ITEM CODE	COLOUR	DESCRIPTION
	TK1M2WA11	WHITE	1 M TRACK
	TK1M2WB09	BLACK	1 M TRACK
	TK2M2WA11	WHITE	2 M TRACK
	TK2M2WB09	BLACK	2 M TRACK



LED PANELS

VITO | EZIORECESSED | EZIOSURFACE | VIVRE | VERTOS | VERTOS

VITO

- Vito:** Deep Recessed Panel
- Vivre:** Recessed & Surface application
- Vivre:** Tunable Option available
- MODERN & SLEEK DESIGN

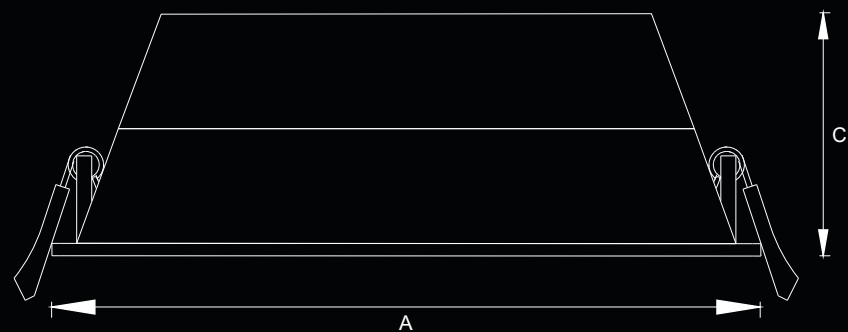

DIMENSIONAL DETAILS

	7.5 W	15 W	20 W
A	7.8 cm	10.3 cm	15.3 cm
C	5.5 cm	5.8 cm	5.8 cm

ITEM CODE	WATTAGE	CCT	DIMENSIONS (in cms)	LUMENS	CRI	IP RATING	SURGE RATING (KV)	BEAM ANGLE
DLP802241	7.5 W	3000K	A - Ø7.8 B - Ø7.2 C - 5.5	510	≥ 80	20	2.5	90°
DLP803241	7.5 W	4000K	A - Ø7.8 B - Ø7.2 C - 5.5	535	≥ 80	20	2.5	90°
DLP806241	7.5 W	6500K	A - Ø7.8 B - Ø7.2 C - 5.5	565	≥ 80	20	2.5	90°
DLP15W3K11	15 W	3000K	A - Ø10.3 B - Ø9.8 C - 5.8	1065	≥ 80	20	2.5	90°
DLP15W4K11	15 W	4000K	A - Ø10.3 B - Ø9.8 C - 5.8	1115	≥ 80	20	2.5	90°
DLP15W6511	15 W	6500K	A - Ø10.3 B - Ø9.8 C - 5.8	1170	≥ 80	20	2.5	90°
DLP20W3K11	20 W	3000K	A - Ø15.3 B - Ø14.3 C - 5.8	1450	≥ 80	20	2.5	100°
DLP20W4K11	20 W	4000K	A - Ø15.3 B - Ø14.3 C - 5.8	1520	≥ 80	20	2.5	100°
DLP20W6511	20 W	6500K	A - Ø15.3 B - Ø14.3 C - 5.8	1570	≥ 80	20	2.5	100°

Dimensions: A- Diameter | B- Cut Out Size | C- Height

LED PANELS

VIVRE 6 IN 1 TUNABLE

LED PANELS

DESCRIPTION

Vito: Recessed Mounted Round Downlighters. Unique combination of high output and low glare.

Smooth design gels perfectly with clean ceiling to get a sophisticated and contemporary look.

Excellent colour consistency throughout the installation

Vivre: Offers "Switch Tunability" and an unique design that enables various mounting options - Recessed, Surface, Junction Box Mounted, within the same product

MATERIAL OF CONSTRUCTION

Vito: Powder Coated Aluminium
Vivre: Polycarbonate

TECHNICAL INFORMATION

Wattage: 7.5W, 15W & 20W
Vivre: 6W & 12W

CRI: ≥80, For Better Light Quality

Input Voltage: 220 V AC - 240 V AC

Surge Protection: ≤2.5KV

IP Rating: IP 20,

Life: ≥30,000 burning hours

Dimmability: On Request. Please get in touch with Tisva Team for Dimming Options

APPLICATION AREA

Residences | Art Galleries | Retail | Museums | Modern Offices

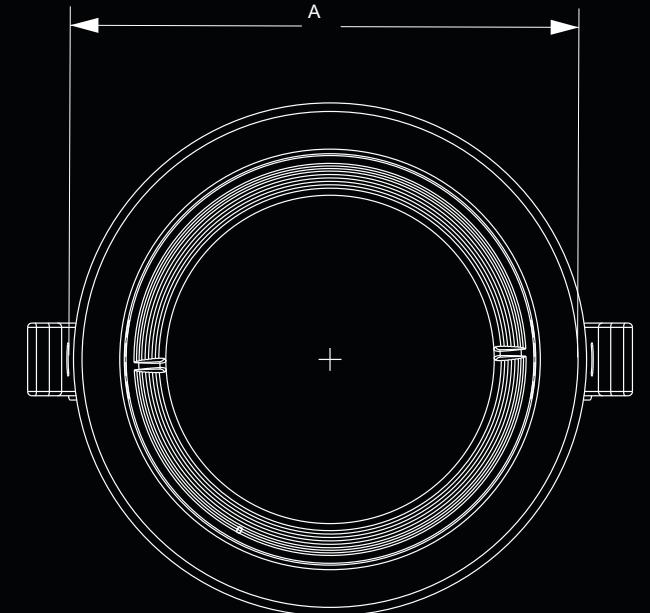

DIMENSIONAL DETAILS

	6 W	12 W
A	12 cm	17 cm
C	3.76 cm	3.76 cm

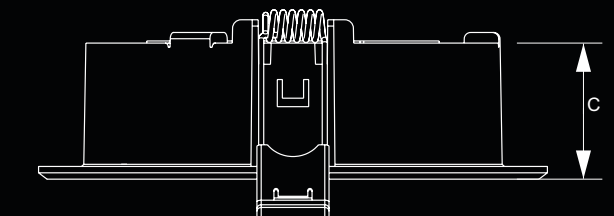

ITEM CODE	WATTAGE	CCT / TUNABILITY	DIMENSIONS (in cms)	CRI	IP RATING	LUMENS	SURGE RATING (KV)	BEAM ANGLE
TNP061921	6 W	SWITCH TUNABLE 3000 K / 4000 K / 6000 K	A - Ø12 B - Ø10.5 C - 3.76	>80	20	400 / 410 / 420	2.5	110°
TNP121922	12 W	SWITCH TUNABLE 3000 K / 4000 K / 6000 K	A - Ø17 B - Ø15.5 C - 3.19	>80	20	1000 / 1050 / 1090	2.5	110°

Dimensions: A- LHW/Diameter | B- Cut Out Size | C- Height

EZIO RECESSED ROUND

- METAL CORE PCB FOR BETTER HEAT DISSIPATION
- DIE CAST POWDER COATED ALUMINIUM HOUSING
- SOFT LIGHT OUTPUT FOR EYE COMFORT
- MODERN & SLEEK DESIGN

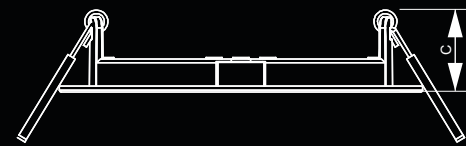
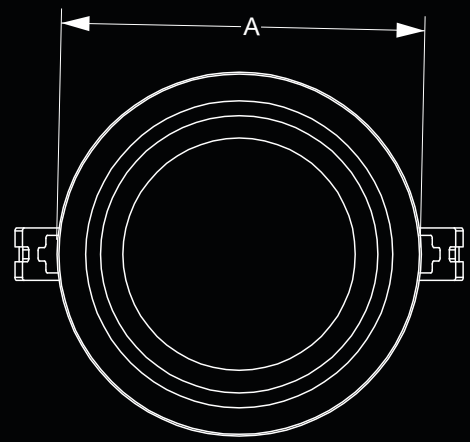

DIMENSIONAL DETAILS

	8 W	12 W & 15W	18 W
A	11.2 cm	16 cm	21.2 cm
C	3 cm	3 cm	3 cm

ITEM CODE	WATTAGE	CCT	DIMENSIONS (in cms)	LUMENS	CRI	IP RATING	SURGE RATING (KV)	INPUT VOLTAGE (AC)	BEAM ANGLE
DLP081123M	8W	3000K	A- Ø11.2 B- Ø10.0 C- 3.0	560	>80	20	2.5	220 V AC - 240 V AC	120°
DLP081323M	8W	4000K	A- Ø11.2 B- Ø10.0 C- 3.0	573	>80	20	2.5	220 V AC - 240 V AC	120°
DLP081623M	8W	6500K	A- Ø11.2 B- Ø10.0 C- 3.0	522	>80	20	2.5	220 V AC - 240 V AC	120°
DLP121123M	12W	3000K	A- Ø16.0 B- Ø14.8 C- 3.0	918	>80	20	2.5	220 V AC - 240 V AC	120°
DLP121323M	12W	4000K	A- Ø16.0 B- Ø14.8 C- 3.0	944	>80	20	2.5	220 V AC - 240 V AC	120°
DLP121623M	12W	6500K	A- Ø16.0 B- Ø14.8 C- 3.0	975	>80	20	2.5	220 V AC - 240 V AC	120°
DLP151123M	15W	3000K	A- Ø16.0 B- Ø14.8 C- 3.0	1176	>80	20	2.5	220 V AC - 240 V AC	120°
DLP151323M	15W	4000K	A- Ø16.0 B- Ø14.8 C- 3.0	1220	>80	20	2.5	220 V AC - 240 V AC	120°
DLP151623M	15W	6500K	A- Ø16.0 B- Ø14.8 C- 3.0	1682	>80	20	2.5	220 V AC - 240 V AC	120°
DLP181123M	18W	3000K	A- Ø21.2 B- Ø20.0 C- 3.0	1402	>80	20	2.5	220 V AC - 240 V AC	120°
DLP181323M	18W	4000K	A- Ø21.2 B- Ø20.0 C- 3.0	1477	>80	20	2.5	220 V AC - 240 V AC	120°
DLP181623M	18W	6500K	A- Ø21.2 B- Ø20.0 C- 3.0	1534	>80	20	2.5	220 V AC - 240 V AC	120°

Dimensions: A- Diameter | B- Cut Out Size | C- Height

LED PANELS RECESSED

DESCRIPTION

Slim Recessed Panels in Round and Square Shape.

Slim design compliments sophisticated and contemporary look

Metal Core PCB and Aluminium Die Cast housing ensures better heat dissipation, thus longer life and better light output over a period of time.

Wide range of wattages to suit variety of spaces

MATERIAL OF CONSTRUCTION

Pressure Die Cast and Powder Coated Aluminium

TECHNICAL INFORMATION

Wattage: 8W, 12W, 15W & 18W

CRI: ≥80, For Better Light Quality

Input Voltage: 220 V AC - 240 V AC

Surge Protection: ≤2.5KV

IP Rating: IP 20,

Life: ≥30,000 burning hours

Dimmability: On Request. Please get in touch with Tisva Team for Dimming Options

APPLICATION AREA

Residences | Art Galleries | Retail | Museums | Modern Offices

EZIO RECESSED SQUARE

LED PANELS

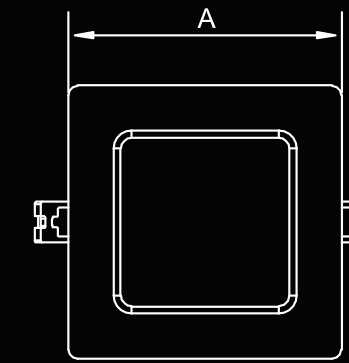

DIMENSIONAL DETAILS

	8 W	12 W & 15W	18 W
A	11.2 cm	16 cm	21.2 cm
C	3 cm	3 cm	3 cm

ITEM CODE	WATTAGE	CCT	DIMENSIONS (in cms)	LUMENS	CRI	IP RATING	SURGE RATING (KV)	INPUT VOLTAGE (AC)	BEAM ANGLE
DLP081143M	8W	3000K	A- Ø11.2 B- Ø10.0 C- 3.0	581	>80	20	2.5	220 V AC - 240 V AC	120°
DLP081343M	8W	4000K	A- Ø11.2 B- Ø10.0 C- 3.0	564	>80	20	2.5	220 V AC - 240 V AC	120°
DLP081643M	8W	6500K	A- Ø11.2 B- Ø10.0 C- 3.0	571	>80	20	2.5	220 V AC - 240 V AC	120°
DLP121143M	12W	3000K	A- Ø16.0 B- Ø14.8 C- 3.0	868	>80	20	2.5	220 V AC - 240 V AC	120°
DLP121343M	12W	4000K	A- Ø16.0 B- Ø14.8 C- 3.0	955	>80	20	2.5	220 V AC - 240 V AC	120°
DLP121643M	12W	6500K	A- Ø16.0 B- Ø14.8 C- 3.0	969	>80	20	2.5	220 V AC - 240 V AC	120°
DLP151143M	15W	3000K	A- Ø16.0 B- Ø14.8 C- 3.0	1132	>80	20	2.5	220 V AC - 240 V AC	120°
DLP151343M	15W	4000K	A- Ø16.0 B- Ø14.8 C- 3.0	1293	>80	20	2.5	220 V AC - 240 V AC	120°
DLP151643M	15W	6500K	A- Ø16.0 B- Ø14.8 C- 3.0	1201	>80	20	2.5	220 V AC - 240 V AC	120°
DLP181143M	18W	3000K	A- Ø21.2 B- Ø20.0 C- 3.0	1374	>80	20	2.5	220 V AC - 240 V AC	120°
DLP181343M	18W	4000K	A- Ø21.2 B- Ø20.0 C- 3.0	1373	>80	20	2.5	220 V AC - 240 V AC	120°
DLP181643M	18W	6500K	A- Ø21.2 B- Ø20.0 C- 3.0	1598	>80	20	2.5	220 V AC - 240 V AC	120°

Dimensions: A- LxW/Diameter | B- Cut Out Size | C- Height

EZIO SURFACE ROUND

- METAL CORE PCB FOR BETTER HEAT DISSIPATION
- DIE CAST POWDER COATED ALUMINIUM HOUSING
- SOFT LIGHT OUTPUT FOR EYE COMFORT
- MODERN & SLEEK DESIGN
-

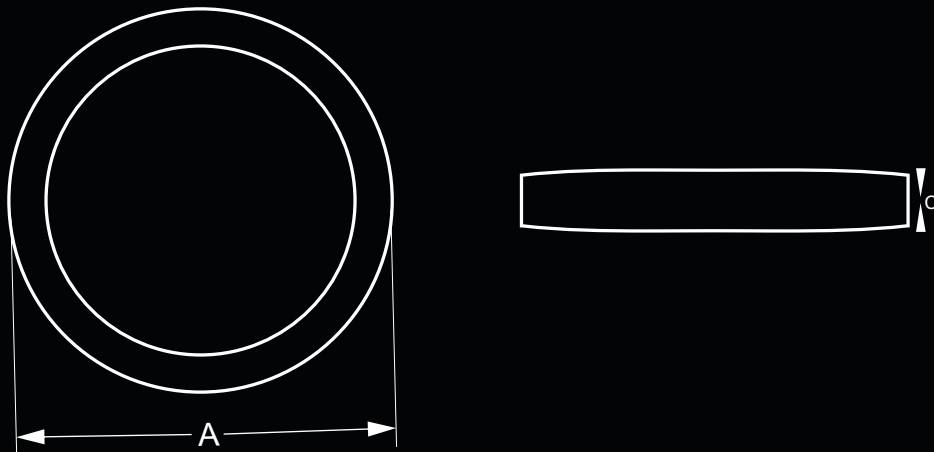

DIMENSIONAL DETAILS

	8 W	12 W & 15W	18 W
A	11.2 cm	16 cm	21.2 cm
C	3 cm	3 cm	3 cm

ITEM CODE	WATTAGE	CCT	DIMENSIONS (in cms)	LUMENS	CRI	IP RATING	SURGE RATING (KV)	INPUT VOLTAGE (AC)	BEAM ANGLE
DLP082123M	8W	3000K	A- Ø11.2 B- Ø10.0 C- 3.0	557	>80	20	2.5	220 V AC - 240 V AC	120°
DLP082323M	8W	4000K	A- Ø11.2 B- Ø10.0 C- 3.0	561	>80	20	2.5	220 V AC - 240 V AC	120°
DLP082623M	8W	6500K	A- Ø11.2 B- Ø10.0 C- 3.0	539	>80	20	2.5	220 V AC - 240 V AC	120°
DLP122123M	12W	3000K	A- Ø16.0 B- Ø14.8 C- 3.0	870	>80	20	2.5	220 V AC - 240 V AC	120°
DLP122323M	12W	4000K	A- Ø16.0 B- Ø14.8 C- 3.0	951	>80	20	2.5	220 V AC - 240 V AC	120°
DLP122623M	12W	6500K	A- Ø16.0 B- Ø14.8 C- 3.0	1000	>80	20	2.5	220 V AC - 240 V AC	120°
DLP152123M	15W	3000K	A- Ø16.0 B- Ø14.8 C- 3.0	1152	>80	20	2.5	220 V AC - 240 V AC	120°
DLP152323M	15W	4000K	A- Ø16.0 B- Ø14.8 C- 3.0	1201	>80	20	2.5	220 V AC - 240 V AC	120°
DLP152623M	15W	6500K	A- Ø16.0 B- Ø14.8 C- 3.0	1234	>80	20	2.5	220 V AC - 240 V AC	120°
DLP182123M	18W	3000K	A- Ø21.2 B- Ø20.0 C- 3.0	1404	>80	20	2.5	220 V AC - 240 V AC	120°
DLP182323M	18W	4000K	A- Ø21.2 B- Ø20.0 C- 3.0	1446	>80	20	2.5	220 V AC - 240 V AC	120°
DLP182623M	18W	6500K	A- Ø21.2 B- Ø20.0 C- 3.0	1572	>80	20	2.5	220 V AC - 240 V AC	120°

Dimensions: A- LHW/Diameter | B- Cut Out Size | C- Height

LED PANELS SURFACE

DESCRIPTION

Slim Surface Panels in Round and Square Shape.

Slim design compliments sophisticated and contemporary look

Metal Core PCB and Aluminium Die Cast housing ensures better heat dissipation, thus longer life and better light output over a period of time.

Wide range of wattages to suit variety of spaces

MATERIAL OF CONSTRUCTION

Pressure Die Casts and Powder Coated Aluminium

TECHNICAL INFORMATION

Wattage: 8W, 12W, 15W & 18W

CRI: ≥80, For Better Light Quality

Input Voltage: 220 V AC - 240 V AC

Surge Protection: ≤2.5KV

IP Rating: IP 20,

Life: ≥30,000 burning hours

Dimmability: On Request. Please get in touch with Tisva Team for Dimming Options

APPLICATION AREA

Residences | Art Galleries | Retail | Museums | Modern Offices

EZIO SURFACE SQUARE

LED PANELS

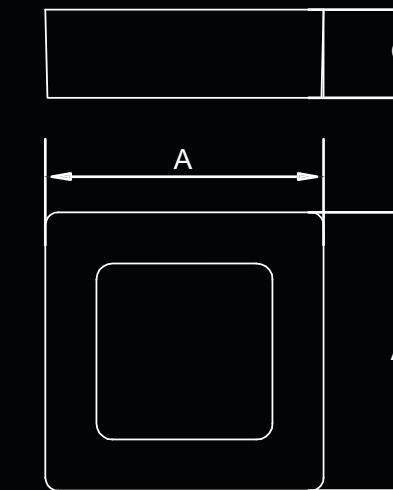

DIMENSIONAL DETAILS

	8 W	12 W & 15W	18 W
A	11.2 cm	16 cm	21.2 cm
C	3 cm	3 cm	3 cm

ITEM CODE	WATTAGE	CCT	DIMENSIONS (in cms)	LUMENS	CRI	IP RATING	SURGE RATING (KV)	INPUT VOLTAGE (AC)	BEAM ANGLE
DLP082143M	8W	3000K	A- Ø11.2 B- Ø10.0 C- 3.0	564	>80	20	2.5	220 V AC - 240 V AC	120°
DLP082343M	8W	4000K	A- Ø11.2 B- Ø10.0 C- 3.0	556	>80	20	2.5	220 V AC - 240 V AC	120°
DLP082643M	8W	6500K	A- Ø11.2 B- Ø10.0 C- 3.0	543	>80	20	2.5	220 V AC - 240 V AC	120°
DLP122143M	12W	3000K	A- Ø16.0 B- Ø14.8 C- 3.0	912	>80	20	2.5	220 V AC - 240 V AC	120°
DLP122343M	12W	4000K	A- Ø16.0 B- Ø14.8 C- 3.0	991	>80	20	2.5	220 V AC - 240 V AC	120°
DLP122643M	12W	6500K	A- Ø16.0 B- Ø14.8 C- 3.0	981	>80	20	2.5	220 V AC - 240 V AC	120°
DLP152143M	15W	3000K	A- Ø16.0 B- Ø14.8 C- 3.0	1162	>80	20	2.5	220 V AC - 240 V AC	120°
DLP152343M	15W	4000K	A- Ø16.0 B- Ø14.8 C- 3.0	1308	>80	20	2.5	220 V AC - 240 V AC	120°
DLP152643M	15W	6500K	A- Ø16.0 B- Ø14.8 C- 3.0	1171	>80	20	2.5	220 V AC - 240 V AC	120°
DLP182143M	18W	3000K	A- Ø21.2 B- Ø20.0 C- 3.0	1355	>80	20	2.5	220 V AC - 240 V AC	120°
DLP182343M	18W	4000K	A- Ø21.2 B- Ø20.0 C- 3.0	1426	>80	20	2.5	220 V AC - 240 V AC	120°
DLP182643M	18W	6500K	A- Ø21.2 B- Ø20.0 C- 3.0	1634	>80	20	2.5	220 V AC - 240 V AC	120°

Dimensions: A- LHW/Diameter | B- Cut Out Size | C- Height

VERTOS

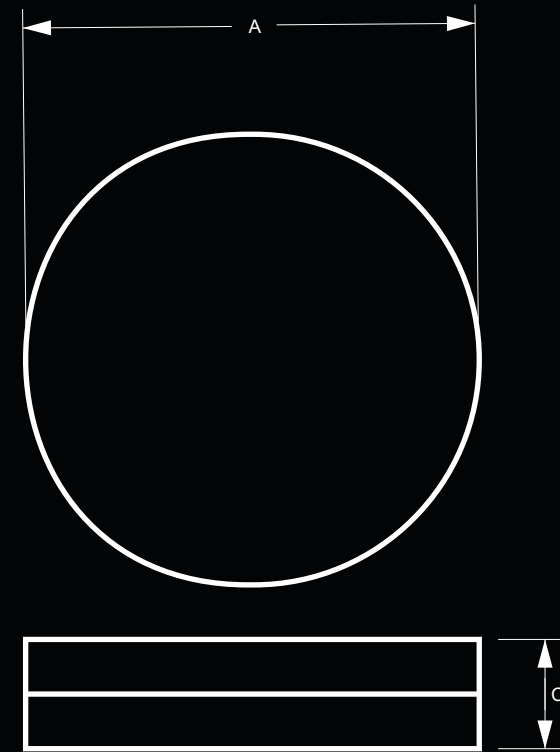

SOFT LIGHT
OUTPUT FOR
EYE COMFORT

MODERN
&
SLEEK DESIGN



DIMENSIONAL DETAILS

	6 W	12 W	18 W	24 W
A	9.0 cm	12.0 cm	15.5 cm	19.0cm
C	2.7 cm	2.7 cm	2.7 cm	2.7cm

ITEM CODE	WATTAGE	CCT	DIMENSIONS (in cms)	LUMENS	CRI	IP RATING	SURGE RATING (KW)	INPUT VOLTAGE (AC)	BEAM ANGLE
DLP616411	6W	6500K	A - Ø9.0 C - 2.7	500	>80	20	2.5	220 V AC - 240 V AC	120°
DLP126114	12W	6500K	A - Ø12.0 C - 2.7	1000	>80	20	2.5	220 V AC - 240 V AC	120°
DLP186114	18W	6500K	A - Ø15.5 C - 2.7	1500	>80	20	2.5	220 V AC - 240 V AC	120°
DLP246114	24W	6500K	A - Ø19.0 C - 2.7	1900	>80	20	2.5	220 V AC - 240 V AC	120°

Dimensions: A- LHW/Diameter | B- Cut Out Size | C- Height

LED PANELS

LED PANELS

DESCRIPTION

Surface Mounted Round Downlighters. Unique combination of high output and low glare.

Slim design gels perfectly with clean ceiling to get a sophisticated and contemporary look.

Excellent colour consistency throughout the installation

MATERIAL OF CONSTRUCTION

Polycarbonate

TECHNICAL INFORMATION

Wattage: 8W, 12W, 18W & 24W

CRI: ≥80, For Better Light Quality

Input Voltage: 220 V AC - 240 V AC

Surge Protection: ≤2.5KV

IP Rating: IP 20,

Life: ≥30,000 burning hours

Dimmability: On Request. Please get in touch with Tisva Team for Dimming Options

APPLICATION AREA

Residences | Art Galleries | Retail | Museums | Modern Offices



Dimensions: A- LHW/Diameter | B- Cut Out Size | C- Height

COMMERCIAL PANELS

Increase workspace efficiency and productivity with Tisva commercial panels. These lights fit smoothly with most standard ceiling grids, are energy efficient and low on maintenance costs.



ASTER PRO

DESCRIPTION

Recessed mounted 2X2 panels suitable for almost all standard grid ceilings.

Unique combination of high output and very low glare.

Sleek design with special diffuser to ensure a soothing lighting effect

Excellent colour consistency throughout the installation

MATERIAL OF CONSTRUCTION

Aluminium CRCA

TECHNICAL INFORMATION

- Wattage:** 36W
- CRI:** ≥80, For Better Light Quality
- Input Voltage:** 220 V AC - 240 V AC
- Surge Protection:** ≤2.5KV
- IP Rating:** IP 20,
- Life:** ≥25,000 burning hours
- Dimmability:** On Request. Please get in touch with Tisva Team for Dimming Options

APPLICATION AREA

Residences | Art Galleries | Retail | Museums | Modern Offices

COMMERCIAL 2 X 2 PANELS

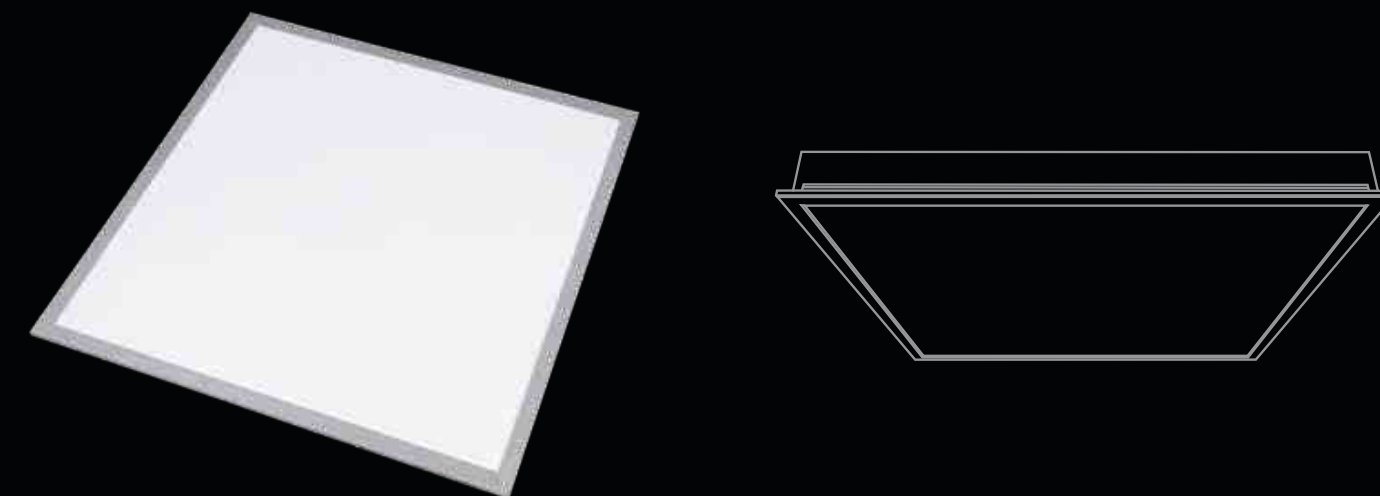

ITEM CODE	WATTAGE	CCT	DIMENSIONS (in cms)	LUMENS	CRI	IP RATING	SURGE RATING (IKU)	INPUT VOLTAGE (AC)
BP361325D	36W	4000K	L - 59.5 W - 59.5 H - 3.0	3780	80	20	3.5	220 V AC - 240 V AC
BP361625D	36W	6500K	A - 59.5 B - 59.5 C - 3.0	3950	80	20	3.5	220 V AC - 240 V AC



LED STRIPS

LUMESERIES-INDOOR | LUMESERIES-OUTDOOR | LUMESERIES-RGBWW | LUMESERIES-ROPELIGHT

LUME SERIES LED STRIP LIGHT

IP 20 - FOR INDOOR APPLICATION

ITEM CODE	DESCRIPTION	WATTAGE	CCT	LENGTH	IP RATING	INPUT VOLTAGE (DC)
LSH20Y0505R	FLEHIBLE LED STRIP	5W/M	3000K	5 m	20	24 V DC
LSH20N0505R	FLEHIBLE LED STRIP	5W/M	4000K	5 m	20	24 V DC
LSH20W0505R	FLEHIBLE LED STRIP	5W/M	6500K	5 m	20	24 V DC
LSH20Y10554	FLEHIBLE LED STRIP	10W/M	3000K	5 m	20	24 V DC
LSH20N10554	FLEHIBLE LED STRIP	10W/M	4000K	5 m	20	24 V DC
LSH20W10554	FLEHIBLE LED STRIP	10W/M	6500K	5 m	20	24 V DC
LSH20Y14554	FLEHIBLE LED STRIP	14.4W/M	3000K	5 m	20	24 V DC
LSH20N14554	FLEHIBLE LED STRIP	14.4W/M	4000K	5 m	20	24 V DC
LSH20W14554	FLEHIBLE LED STRIP	14.4W/M	6500K	5 m	20	24 V DC

IP 20 LED STRIP- RGB WW

ITEM CODE	DESCRIPTION	WATTAGE	CCT	LENGTH	IP RATING	INPUT VOLTAGE (DC)
LSH40245	FLEHIBLE LED STRIP	8 W/M	RGB WW	5 M	20	24 V DC
LSH2402C	RF CONTROLLER					
LSH240R	RECTIFIER KIT					

IP 65 - FOR OUTDOOR APPLICATION

ITEM CODE	DESCRIPTION	WATTAGE	CCT	LENGTH	IP RATING	INPUT VOLTAGE (DC)
LSH65Y10554	FLEHIBLE LED STRIP	10w/m	3000K	5 m	65	24 V DC
LSH65N10554	FLEHIBLE LED STRIP	10w/m	4000K	5 m	65	24 V DC
LSH65W10554	FLEHIBLE LED STRIP	10w/m	6500K	5 m	65	24 V DC
LSH65Y14554	FLEHIBLE LED STRIP	14.4w/m	3000K	5 m	65	24 V DC
LSH65N14554	FLEHIBLE LED STRIP	14.4w/m	4000K	5 m	65	24 V DC
LSH65W14554	FLEHIBLE LED STRIP	14.4w/m	6500K	5 m	65	24 V DC



LED STRIP & ROPE LIGHT

DESCRIPTION

Flexible LED Strips for Indoor and out door applications. Options in Warm White, Natural White, Cool White and RGBWW colour options.

TECHNICAL INFORMATION

Wattage: 5W/m, 10W/m, 14.4W/m and 8W/m (RGBWW)

IP Rating: IP20 and IP65 versions available

Input Voltage: 24 V DC

Dimming option: On Request. Please get in touch with Tisva Team for Dimming Options

APPLICATION AREA

Residences | Art Galleries | Retail | Museums | Modern Offices | Etc for Cove Lighting and Out Door Application

LUME ROPE LIGHT



IP 65 - FOR OUTDOOR APPLICATION

ITEM CODE	DESCRIPTION	WATTAGE	CCT	LENGTH	IP RATING	INPUT VOLTAGE (DC)
LSH823K1	FLEHIBLE LED ROPE LIGHT	8W/M	3000K	50 m	65	24 V DC
LSH834KN	FLEHIBLE LED ROPE LIGHT	8W/M	4000K	50 m	65	24 V DC
A6003A240	RECTIFIER KIT					

LUME LED DRIVER

ITEM CODE	WATTAGE	DESCRIPTION
A225012CU	25 W DRIVER	12U NON DIMMABLE IP20
A23A24UP1	72 W DRIVER	24U NON DIMMABLE IP20
A962402CU	96 W DRIVER	24U DC IP20
A962406CU	96 W DRIVER	24U DC IP65

LED DRIVER

ITEM CODE	WATTAGE	DIMENSIONS*
ALDD1230	12W	A - 10.8*10.8 C - 2.4
ALDD1535	15W	A - 10.8*10.8 C - 2.4
ALDD1850	18W	A - 10.8*10.8 C - 2.4
ALDD3070	30W	A - 10.8*10.8 C - 2.8

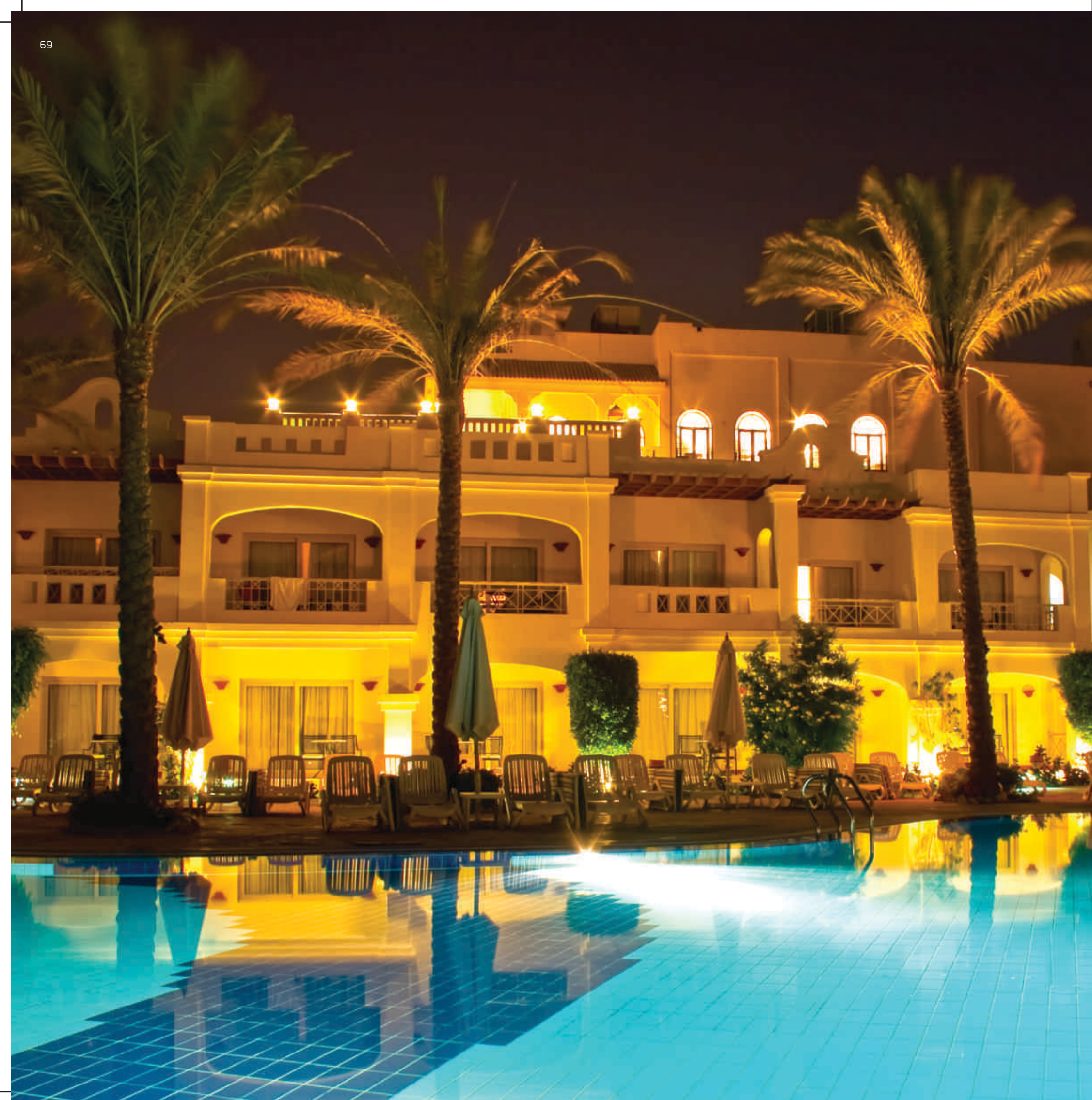

LANDSCAPE LIGHTING

WALLLIGHT | BOLLARDS | POSTTOP | GATELIGHT

WALL LIGHTS



WALL LIGHT - LW12360054
WATT - 2 x 12W LED (IP54)
LAMP BASE - INBUILT LED
CCT - 3000 K



WALL LIGHT - LW62952
WATT - 2 x 3W LED (IP65)
LAMP BASE - INBUILT LED
CCT - 3000 K



WALL LIGHT - LW6320054
WATT - 2 x 6W LED (IP54)
LAMP BASE - INBUILT LED
CCT - 3000 K



WALL LIGHT - LW06254
WATT - 1 x 6W LED (IP54)
LAMP BASE - INBUILT LED
CCT - 3000 K

LANDSCAPE LIGHTS

DESCRIPTION

Wide range of architectural landscape lights that include Wall Lights, bollards, gate lights, post top etc

Designed and developed for outdoor applications.

Easy to install and maintain.

MATERIAL OF CONSTRUCTION

Die cast aluminium

APPLICATION AREA

Outdoor applications like gardens, lawns, pathways, feature walls, pillars, etc

WALL LIGHTS



WALL LIGHT - LW18156
WATT - 3 x 6W LED (IP65)
LAMP BASE - INBUILT LED
CCT - 3000 K

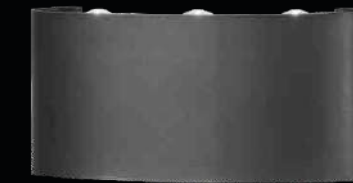

WALL LIGHT - LW12390054
WATT - 6 x 12W LED (IP54)
LAMP BASE - INBUILT LED
CCT - 3000 K



WALL LIGHT - LW124952
WATT - 4 x 3W LED (IP65)
LAMP BASE - INBUILT LED
CCT - 3000 K

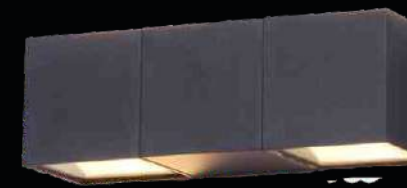

WALL LIGHT - LW12254
WATT - 12W LED (IP54)
LAMP BASE - INBUILT LED
CCT - 3000 K

WALL LIGHTS



WALL LIGHT - LCL20152
 WATT - 2 x 10W LED (IP65)
 LAMP BASE - INBUILT LED
 CCT - 3000 K



WALL LIGHT - LGT121W1
 WATT - 1 x 12W LED (IP65)
 LAMP BASE - INBUILT LED
 CCT - 3000 K



WALL LIGHT - LW1215441
 WATT - 4 x 3W LED (IP65)
 LAMP BASE - INBUILT LED
 CCT - 3000 K

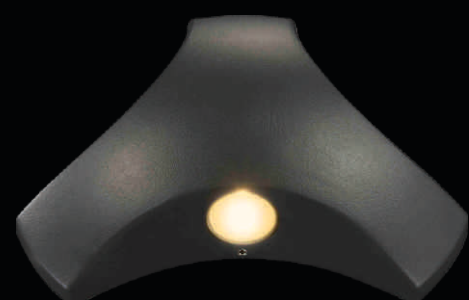

WALL LIGHT - LW90151
 WATT - 3 x 3W LED (IP65)
 LAMP BASE - INBUILT LED
 CCT - 3000 K

WALL LIGHTS



WALL LIGHT - - LW08254
 WATT - 8W LED (IP54)
 LAMP BASE - INBUILT LED
 CCT - 3000 K



WALL LIGHT - LW09152
 WATT - 2 x 4.5W LED (IP65)
 LAMP BASE - INBUILT LED
 CCT - 3000 K



WALL LIGHT - - LW12152
 WATT - 2 x 6W LED (IP65)
 LAMP BASE - INBUILT LED
 CCT - 3000 K



WALL LIGHT - LW81A510
 WATT - 1 x 8W LED (IP65)
 LAMP BASE - INBUILT LED
 CCT - 3000 K

POSTTOP



GATE LIGHT - LGT12151
 WATT - 1 x 12W LED (IP65)
 LAMP BASE - INBUILT LED



BOLLARD - LB155171
 WATT - 1 x 15W LED (IP65)
 LAMP BASE - INBUILT LED

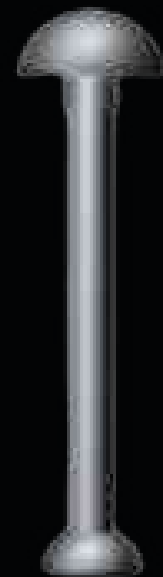

BOLLARD - LB155131
 WATT - 1 x 15W LED (IP65)
 LAMP BASE - INBUILT LED
 CCT - 3000 K

BOLLARDS & POSTTOP

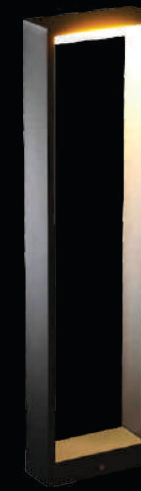

BOLLARD - LB155161
 WATT - 1 x 15W LED (IP65)
 LAMP BASE - INBUILT LED
 CCT - 3000 K



BOLLARD - LB155141
 WATT - 1 x 15W LED (IP65)
 LAMP BASE - INBUILT LED
 CCT - 3000 K



POST TOP
 WATT - 40W LED (IP65)
 LAMP BASE - INBUILT LED

ITEM CODE	CCT
LPT40143	3000K
LPT40343	4000K
LPT40643	6500K
LPT40103	4000K

ROLL OF HONOUR

Some of the projects that we are proud to be a part of

INFRASTRUCTURE PROJECTS

1. Rashtrapati Bhawan
2. Lucknow Vidhansabha
3. Governor House, Bihar
4. Chief Minister House, New Delhi
5. Statue of Unity, Kevadia Gujrat
6. Onkareshwar Temple, Madhya Pradesh
7. Mahakaleshwar Temple, Ujjain
8. Karila Devi Temple, Madhya Pradesh
9. Iskon Temple, Rohini, Delhi
10. NDMC ED Office, New Delhi
11. Kashi Vishwanath Temple, Varanasi
12. GMR Goa International Airport, Mopa, Goa
13. Delhi Metro Officers Residential, Okhla
14. NBCC Apartment Dwarka
15. Hindon Airforce Base, Ghaziabad

HOTELS

1. ITC Tauleen, Chail Himachal Pradesh
2. Holiday Inn, Manesar, Haryana
3. Sarovar Portico Gaur City, Noida
4. Courtyard by Marriott, Faridabad
5. Lemon Tree, Chennai
6. Lemon Tree, Bangalore
7. Lemon Tree, Goa
8. Lemon Tree, Pune
9. Lemon Tree, Kausambi
10. Radisson, Srinagar
11. Radisson, Rajbag
12. Radisson, Sonmarg
13. Radisson, Pahalgam
14. Dunsuirk Court Hotel, Mussorie
15. Taj, Amer
16. A.A. Hotel, Amritsar

COMMERCIAL & OFFICE

1. SBI Head Office, Delhi
2. SBI Branch, Okhla, Delhi
3. SBI Guest House
4. Concentrix, Gurgaon
5. Honda Factory, Manesar
6. Yash Jewellers, Amritsar
7. Home Ministry, Chief Secretary Office, New Delhi
8. PNB Connought Place, Delhi
9. Aduent IT Park
10. SGS Technology
11. Policy Bazar
12. NTAI, Delhi
13. Kanha Ashram, Hyderabad

EDUCATIONAL INSTITUTIONS

1. IMT Ghaziabad
2. DAV Schools
3. Lotus Valley School, Greater Noida
4. Woodstock School, Mussorie
5. Gurukul, The School
6. Rishihood University
7. Delhi Public School, Noida, Sec 132
8. Greater Noida World School
9. Sriram Millenium School, Noida
10. Millenium School, Lucknow
11. Delhi Public School, Lucknow
12. Seth M. A. Jaipuria School, Lucknow
13. Guru Nanak School, Ranchi
14. PGDAU, Lajpat Nagar
15. DAV, Pahadganj, Delhi
16. Aryan World School, Pune
17. Hostel Block, Galgotia University

BUILDERS & DEVELOPERS

1. DLF Camelias
2. Central Park 2 & 3, Gurgaon
3. BPTP Faridabad
4. AIPL, Gurgaon
5. Wave Buider City, Noida
6. Anathraj, Gurgaon
7. M2K County, Dharuhera
8. M3M IFC, Gurgaon
9. Sushma Buidtech, Chandigarh
10. Shalimar One World, Lucknow
11. TDI, Faridabad
12. Prestige Falcon City, Bangalore
13. Lodha Belezza, Hyderabad

HOSPITALS

1. Amara Raja Hospital, Andhra Pradesh
2. Meenakshi Hospital, Andhra Pradesh
3. Fortis Cancer Institute, Delhi
4. Rainbow Children Hospital, Delhi
5. IUF Hospital, Hyderabad

.....AND MANY MORE

Disclaimer:

Due to continuous efforts in developing and improving products, we reserve the rights to make changes in the design and data or withdraw the product without any prior notice.

Every effort has been made to ensure accuracy in compilation of technical detail within this publication. However, customer is advised to check exact product details with the company before buying the product. We shall not be responsible for any loss arising out of any error in this catalogue.

All product and installation images are indicative only.

Disputes, if any, are subject to Delhi jurisdiction only

USHA INTERNATIONAL LTD.

Plot No. 15, Institutional Area, Sector 32, Gurugram – 122001 Haryana (India)
Telephone: +91 124 4583100, Fax: +91 124 4583200
Website: www.lightsbytisua.com, E-mail: customer_care@lightsbytisua.com